

# The Wireless World

THE  
PRACTICAL RADIO  
JOURNAL  
27<sup>th</sup> Year of Publication

No.937.

FRIDAY, AUGUST 13TH, 1937.

VOL. XLII. No. 7.

Proprietors: ILIFFE & SONS LTD.

Editor:  
HUGH S. POCOCK.

Editorial,  
Advertising and Publishing Offices:  
DORSET HOUSE, STAMFORD STREET,  
LONDON, S.E.1.

Telephone: Waterloo 3333 (50 lines).  
Telegrams: "Ethaworld, Sedist, London."

COVENTRY: Hertford Street.  
Telegrams: "Autocar, Coventry." Telephone: 5210 Coventry.

BIRMINGHAM:  
Guildhall Buildings, Navigation Street, 2.  
Telegrams: "Autopress, Birmingham." Telephone: 2971 Midland (4 lines).

MANCHESTER: 260, Deansgate, 3.  
Telegrams: "Iliffe, Manchester." Telephone: Blackfriars 4412 (4 lines).

GLASGOW: 26B, Renfield Street, C.2.  
Telegrams: "Iliffe, Glasgow." Telephone: Central 4857.

PUBLISHED WEEKLY. ENTERED AS SECOND-  
CLASS MATTER AT NEW YORK, N.Y.

Subscription Rates:

Home, £1 1s. 8d.; Canada, £1 1s. 8d.; other  
countries, £1 3s. 10d. per annum.

*As many of the circuits and apparatus described in these  
pages are covered by patents, readers are advised, before  
making use of them, to satisfy themselves that they would  
not be infringing patents.*

## CONTENTS

	Page
Editorial Comment .. .. .	133
The Hammond Electro-Acoustic Organ .. .. .	134
Audio-Frequency Curve Tracer ..	137
Notes and News .. .. .	138
The Berlin Radio Show .. .. .	139
Measuring Mutual Conductance ..	143
British and German Television ..	145
Listeners' Guide for the Week ..	147
Broadcast Brevities .. .. .	148
Unbiased .. .. .	149
Letters to the Editor .. .. .	150
Pilot Battery Superhet Reviewed ..	152
Random Radiations .. .. .	154
New Apparatus Reviewed .. .. .	156

## EDITORIAL COMMENT

### Sets for Export

#### A Lesson from Berlin

**A**T the opening of the Berlin Radio Show on July 30th, the Minister of Propaganda, Dr. Goebbels, after announcing details of the programme for a new and improved People's Set, went on to state that the German radio industry had also got together on the question of a receiver for export. He announced that a joint production, exclusively for sale abroad, had been evolved and would sell at a price which would enable it to compete happily with any similar sets of foreign origin.

Whilst we admire the enterprise of the German radio industry, and particularly the ability shown to co-operate in a matter of this kind, we cannot help expressing regret that no effort to deal more effectively with the demand for British radio sets overseas has yet been made by our own industry. For years now we have been receiving letters from readers abroad, particularly in the Dominions and Colonies, expressing their disappointment because British sets, satisfactory for their conditions, are unobtainable and their place is being taken by sets of foreign manufacture.

The German plan to produce a standardised set for overseas in just the same way as they planned the production of the People's Set for the Fatherland cannot be regarded as a new idea because such a policy was urged upon British manufacturers in a Leader in *The Wireless World* as long ago as February of last year. The title of the Leader to which we refer was "British Sets for Overseas—a Standard Design for Export?" In that Leader we deplored the fact that British manufacturers were paying so little attention to overseas requirements and

expressed the view that the reason was that our manufacturers had never yet seriously set about providing for this market. We recommended then, as we had done on previous occasions, that the British manufacturers ought to tackle the problem in such a way as to avoid competition between themselves, and that to this end, they might agree upon territories where individual manufacturers could supply. We put forward as our suggestion that, because the position had become so urgent by reason of a long delay in making a start, some unusual method of procedure seemed imperative beyond the mere proposal to avoid competition.

#### Our Proposal

We recommended that British designers "should pool their knowledge and produce a specification for a dependable and efficient receiver for overseas use and that manufacturers here should agree, through their Association, to standardise their production of sets for overseas to this specification." We expressed the view that such an arrangement would result in a better set at a much lower cost and would, in addition, solve the difficulty of spare parts and servicing to a very great extent.

We can only hope that the lesson from Germany will have the effect of waking up our industry to make some really effective move. The whole matter has been left in such a deplorable state that it will require very great activity to capture markets so long neglected, but we believe that even now there is, judging from the correspondence which we receive, sufficient good will towards products of British manufacture to give them an advantage over competitors, provided that price, performance and service reach a standard equal to that of rivals.

# The Hammond Organ

A NEW ELECTRO-ACOUSTICAL MUSICAL INSTRUMENT By W. BAGGALLY, M.I.W.T.

*IN a pipe organ the harmonic context of the various stops is irrevocably fixed, but the player of the musical instrument described in this article has almost unlimited scope in producing different tone colours by adding harmonics to the various pure tones generated by electro-mechanical means.*

**T**HERE has recently been introduced into this country a musical instrument known as the Hammond organ. The instrument, which is of American origin, is entirely electrical in action, the sounds being produced by loud speakers of the conventional moving-coil cone type. It is capable of producing all the varieties of tone colour and volume to be found in even the largest pipe organs, together with many tones of an entirely novel character, and at a small fraction of the cost and size of a conventional organ of comparable performance. The present writer has recently purchased one of these instruments for his own use and thinks that a description of it might be of interest to other *Wireless World* readers; hence this article.

The organ consists of two parts; the console and the power cabinet. The console is shown in Fig. 1; it comprises the two manuals or rows of keys and the pedal keyboard, together with the harmonic controllers, etc., to be described below. It

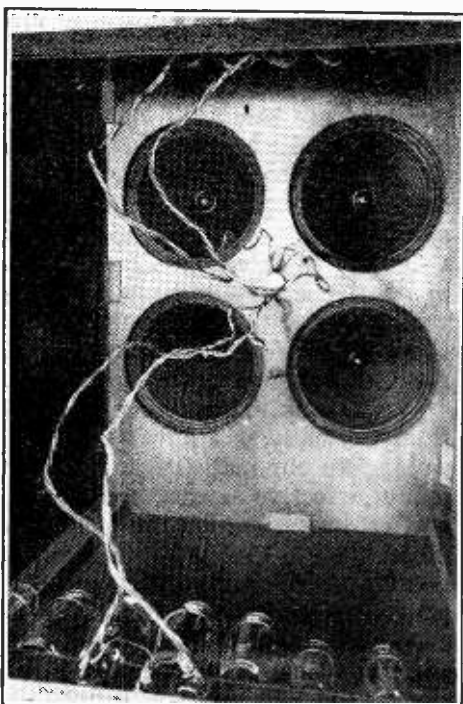

Fig. 2.—Interior view (taken with a wide-angle lens) of the cabinet containing the loud speakers and power amplifiers, etc.

contains the mechanism for generating the sinusoidal voltages from which the final sounds are built up, together with a two-stage pre-amplifier. The interior of power cabinet, which externally is similar to a large gramophone cabinet, is shown in Fig. 2. This photograph was taken with the camera pointing vertically upwards into the cabinet, which is open at the bottom and covered by a light dust-proof grille at the top. The power cabinet contains two identical 20-watt amplifiers, of which the valves may be seen in the photograph. Four Jensen loud speakers are arranged in pairs, two being fed from each amplifier. This system is very flexible, since for more powerful installations it is merely necessary to couple up more amplifiers, each of which is complete with two loud speakers and self-contained power supply.

The shelf carrying the loud speakers is built about a third of the way from the top of the cabinet, and to obviate "box-resonance" in the lower part of the cabinet a wooden tube extends from the underside of the shelf to the top of the cabinet. The tube is triangular in section, and the open end of it is just discernible in the corner of the shelf. It acts as an acoustical damping resistance at low frequencies. Each amplifier has four RCA Type 2A3 triodes in parallel-push-pull in the output stage.

The power cabinet is connected to the console by a three-pair cable carrying: (1) The AC supply to the amplifiers, which is switched on and off from the console; (2) HT for the pre-amplifier in the console, brought back from the rectifiers of the power amplifiers; and (3) the musical frequencies, generated in the console and fed to the power amplifiers.

The principle of action of the tone generator in the console is simple and ingenious; it is illustrated in Fig. 3, which almost explains itself. The tone wheel is made of iron and corrugated around the edge. In rotating in proximity to the end



Fig. 1.—The console unit, which also contains the mechanism for generating the musical frequencies and a pre-amplifier.

of the bar magnet it produces cyclical changes in the magnetic flux linking the coil, thus inducing an alternating EMF in the latter. The amplitude of this EMF is set by sliding the magnet along its length in a collar fitted with a grub-screw (not shown in Fig. 3).

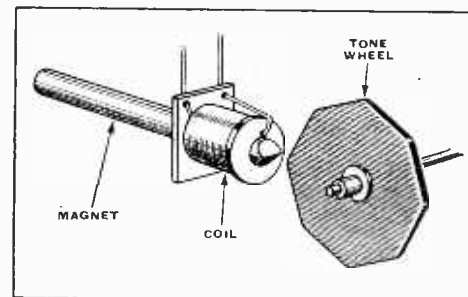

Fig. 3.—Diagrammatic sketch showing the principle of the tone generator.

Ninety-one of these miniature alternators, each producing a pure tone corresponding to a note of the tempered musical scale, are mounted in rows on shafts which are geared together and driven by a synchronous motor from 50-cycle AC mains. An auxiliary non-synchronous starting motor is automatically declutched when the apparatus has pulled into step. A mechanical low-pass filter consisting of a flywheel on the motor shaft coupled to a second free-running flywheel by a spring, the free flywheel being coupled by a second spring to the tone generator, ensures that the angular velocity of the latter remain constant. At this point one of the great advantages of the Hammond organ over the conventional pipe-organ becomes apparent; the organ cannot get out of tune, and its pitch is unaffected by climatic conditions.

The tone generator produces pure sinusoidal voltages only. Now pure tones are not used in music, but in order to produce the complex tones corresponding to the various stops of the pipe organ (Open Diapason, Flute, Tuba, etc.) it is merely necessary to select from the tone generator pure tones corresponding in frequency to the fundamental, second harmonic, third

**The Hammond Organ—**

harmonic, and so on, and then to mix them in the right proportions so as to build up an accurate copy of the required waveform by Fourier synthesis. There is, of course, the theoretical objection that the frequencies of some of the tones are not truly harmonic, but are tempered scale tones. However, the second, fourth, and eighth are true, being octaves of the fundamental, and in practice the slight mistuning of the other overtones is not of significance musically. The method of carrying out the required synthesis will now be described.

**Controlling Harmonic Amplitude**

Four harmonic controllers, each consisting of nine drawbars, are provided. These drawbars correspond to the sub-fundamental, sub-third harmonics, fundamental and each of the harmonics up to the eighth. The first two enable "sixteen-foot tone" to be obtained on the manuals.

Each drawbar has nine positions. When it is pushed right in, the corresponding harmonic does not sound. As it is pulled out the amplitude of the harmonic increases exponentially until, with the drawbar pulled out as far as it will go, that particular harmonic is sounding at maximum intensity. The drawbars are numbered along their length from 1 to 8: thus any tone quality is designated by a nine-figure number (one figure for each drawbar), and, when once found and logged, may be repeated at will.

The left-hand pair of harmonic controllers are for the upper manual, and the right-hand pair for the lower manual. Each is brought into play by depressing the corresponding "switch-key."

Other keys bring pre-set tone-colour combinations into play which are not adjustable from the manuals, but are permanently set up; such, for example, as Open Diapason, Oboe, Clarinet, Full Organ, and other things which are in constant use by the organist. These pre-set combinations may be changed by altering



Fig. 4.—The left-hand end of the manuals.

the connections on a terminal board. When a reverse colour key is depressed it stays down until another is depressed, when it springs up again. In order to play

on the manuals it is necessary first to depress either one of the pre-set keys or a switch key, and, if the latter, to set up a tone colour on the corresponding harmonic controller; the playing keys will then speak. The controls for the pedal organ consist of the two drawbars in the middle of the console. The left-hand drawbar

the appropriate key, connecting other coils makes an inappreciable difference to the voltage delivered by the first coil to the transformer primary and hence to the pre-amplifier; which means that when we strike chords there is not an appreciable reduction of volume of the individual notes from what it would be if they were

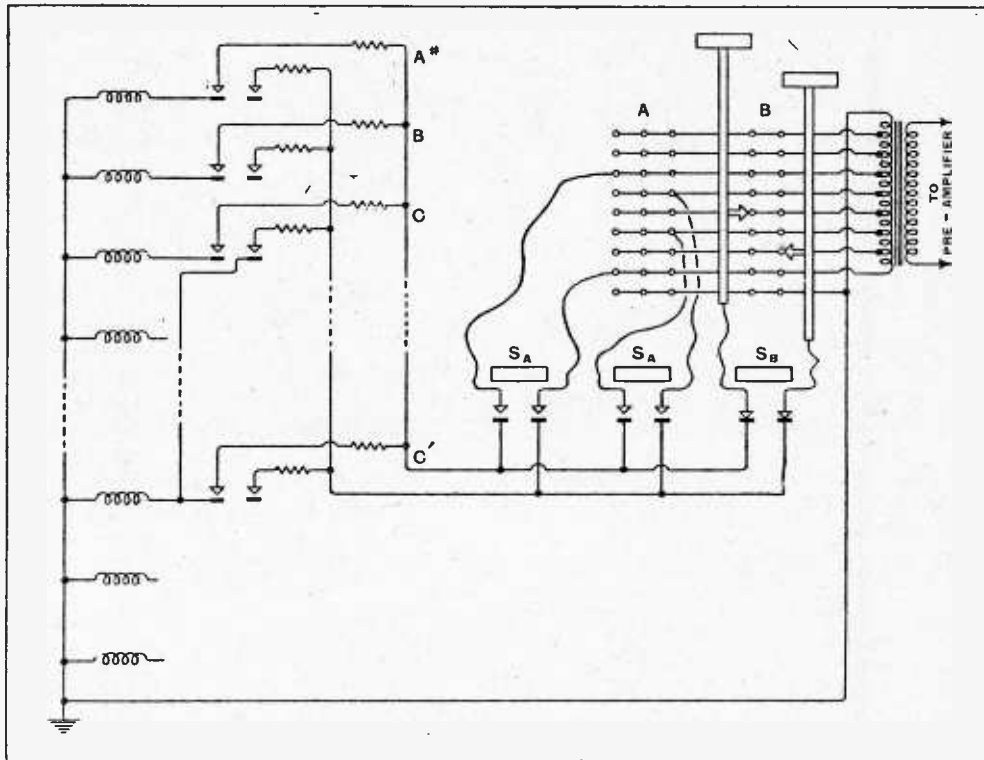

Fig. 5.—Simplified diagram showing electrical details of the controlling system

controls a mixture of sixteen-foot fundamental and even harmonics, whilst the right-hand drawbar controls the odd harmonics. This simplified control gives all the flexibility required at these low frequencies (the bottom note of the 16ft. rank is 32 cycles per second).

The electrical connections and arrangements whereby these things are done are somewhat as shown in Fig. 5, wherein for simplicity only the fundamental and one harmonic are shown.

In the actual instrument each playing key, and also each pre-set or switch key, closes a nine-pole switch when depressed; two-pole switches only are shown in Fig. 5, wherein A is the pre-set terminal board; B, one of the harmonic controllers; SA, pre-set keys; SB, a switch key; A#, B, C, C', playing keys, where C' is the octave of C. The coils of the tone generator are shown on the extreme left. The impedance of the primary of the transformer is much lower than that of the coils, etc., so that if a coil is connected by depressing

sounded separately. The ingenious method of adjusting the level of the harmonics by tapping up and down the transformer primary will be noted.

If we depress the note C, the second harmonic, C', will speak on the second contact of the C playing key. If now the note C' be struck, the resistance in series with its fundamental contact is put in parallel with the resistance in series with the second harmonic contact of the C key (assuming that fundamental and second harmonic are adjusted to the same tap on the transformer); thus it is that with both keys depressed the note C' will speak more loudly than if either is depressed alone: without the series resistances this would not occur.

**Controlling Tremolo**

There is a tremulant, consisting of a stepped attenuation network, or volume control, operated by a cam on the motor shaft. This arrangement gives the same result as the pipe-organ tremulant, which consists of a small vibrating bellows or other similar device for superimposing a cyclical variation on the wind pressure to the pipes, and so producing corresponding cyclical changes in the amplitude of the emitted sound. The degree of tremolo is adjustable by means of a rheostat, the knob of which may be seen to the left in Fig. 4.

In a pipe organ it is usual to enclose a

**The Hammond Organ—**

section known as the Swell Organ in a box, the front of which may be opened and closed by a pedal, thereby giving adjustment of volume. In practice, the

yet heard it in the writer's house thought that there were swell shutters being opened and closed in the top of the power cabinet!

To provide for adjusting the perform-

with the manual volume control some way from maximum, though there might be a slight heterodyne. "Excellent" was the mark awarded to those stations which came in with the volume control less than half-way between minimum and maximum, were completely free from audible heterodynes and provided reception to which one could listen with genuine pleasure.

**Forty Stations**

Here are the lists. *Pretty good*: Saarbrücken, Radio-Méditerranée, Frankfort, Nice-Corse, Hörby, Bordeaux Lafayette, Bari No. 1, Brno, Rome, Vienna, Grenoble P.T.T., Budapest. Total 12. *Excellent*: Radio Lyons, Bologna, Lille, Radio Normandie, Rennes, Hilversum No. 2, Torun (Genoa not working), Poste Parisien, Breslau, Brussels No. 2, Radio-Toulouse, Hamburg, Strasbourg, Berlin, Milan No. 1, Leipzig, Toulouse P.T.T., Marseilles P.T.T., Paris P.T.T., Sottens, Cologne, Lyons P.T.T., Prague, Brussels No. 1, Florence, Stuttgart, Athlone and Beromünster. Total 28.

This makes a grand total of forty stations received at good strength and mostly without interference. In some cases sideband splutter was in evidence when a big station on a neighbouring wavelength was transmitting speech; but that, one fears, is inevitable with things as they are. A transmission so affected can be perfectly good when speech is not toward from its powerful neighbour. D. EXER.

**Television  
Programmes**

Regular transmissions recommence on Monday at the usual times—from 3-4 and 9-10.

Vision 45 Mc/s. Sound 41.5 Mc/s.

MONDAY, AUGUST 16th.

3, Miscellany: Indian dancer, singer and a musical comedy, "Capital Punishment." 3.20, Gaumont-British News. 3.30, Jean Forbes-Robertson in scenes from "Romeo and Juliet." 3.50, Film, "Bugle from Blue Grass."

9, Bransby Williams. 9.10, Talk. 9.25, British Movietone news. 9.35, Cabaret cartoons.

TUESDAY, AUGUST 17th.

3, Musical act. 3.10, Fred Drezin, conjurer. 3.20, British Movietone news. 3.30, Play: "Between Ourselves." 3.50, Film, "Klondike Kid."

9, The Irish Players in Lady Gregory's "The Workhouse Ward." 9.30, Gaumont-British News. 9.40, Repetition of 3.30 programme.

WEDNESDAY, AUGUST 18th.

3, Bransby Williams. 3.10, "In the Air": a pageant of model aircraft in the grounds of Alexandra Palace. 3.25, Gaumont-British News. 3.35, Cabaret cartoons.

9, Jean Forbes-Robertson in scenes from "Romeo and Juliet." 9.20, British Movietone news. 9.30, Miscellany: Indian dancer, singer and a musical comedy, "Capital Punishment." 9.50, Film, "Klondike Kid."

THURSDAY, AUGUST 19th.

3, The Irish Players in Bernard Duffy's "The Coiner." 3.30, British Movietone news. 3.40, "Time to Say Goodbye": a review of farewells.

9, Musical act. 9.10, Victor Hotchkiss and his Marionettes. 9.20, Gaumont-British News. 9.30, Variety.

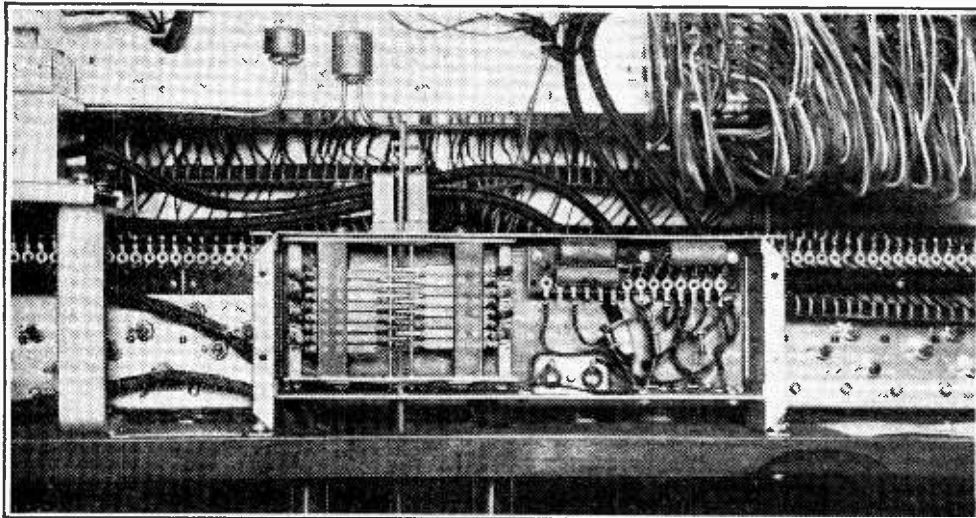

Fig. 6.—Apparatus by means of which the swell effect is produced. The operating rod passes between the two tubes which carry the power cables and the pedal organ cable.

effect of closing the Swell is to attenuate the high frequencies far more than the low frequencies, which latter pass fairly freely through the sides of the swell box; thus a simple volume control designed to attenuate all frequencies equally would not give a good swell effect.

In the Hammond organ the swell pedal controls a stepped attenuator which is so combined with reactive elements as to give but slight attenuation of the deep notes in comparison with those of higher frequency and thus to simulate the closed swell effect so closely that all the organists who have

ance to the acoustics of the building, the swell pedal has an adjustable stop which can be set to prevent the swell being opened too far; there is also a tone-balance control on the pre-amplifier enabling the bass or treble to be accentuated or reduced to compensate for differences in the reverberation characteristic of the building.

The writer's thanks are due to the British agents for the Hammond organ (Messrs. Boosey and Hawkes, 295, Regent Street, London, W.1) for permission to reproduce diagrams used to illustrate this article.

# Distant Reception Notes

## The Lucerne Plan—with Unofficial Modifications

IN my last notes I mentioned a report that Genoa was to leave the 304.3-metre channel and to be synchronised with Turin and Trieste on 263.2 metres, whilst Radio Marconi at Bologna would change from 245.5 to 304.3 metres. As the result of a good many recent observations with the receiving set I can hardly bring myself to believe that the Bologna station is likely to shift to 304.3 metres. On that wavelength there is already the Polish station Torun, rated at 24 kilowatts. The arrangement that a Polish and an Italian station should share the wavelength dates back to the beginning of the Lucerne Plan.

On several recent evenings I have found Torun working by itself and I can quite believe in the likelihood of the transfer of Genoa to 263.2 metres, for Torun comes in strongly in this country and might well cause serious interference with Genoa in Italy. It seems hardly probable that the authorities would deliberately choose a channel where there is interference for Radio Marconi—unless, of course, they feel that this station is strong enough to shout it down in its own service area.

It is rather interesting to note that under

the Lucerne Plan 304.3 metres is an "international common wavelength, type 1." Stations sharing such a wavelength were limited by the original convention to 2 kilowatts. However, the power limitations on all types of common wavelengths seem to have gone largely by the board.

The other night I thought it would be interesting to see how the Lucerne Plan in its up-to-date form was working on the medium-wave band and I spent a couple of hours between half-past nine and half-past eleven in running over it. The set used was a 6-valve superhet whose sensitiveness and selectivity are probably both a little above the average. Frankly, I was astonished at the number of stations whose programmes could be received with real entertainment value. I should, perhaps, mention that on that night there was no fading that AVC could not cope with, and that though there were mild atmospherics they were not really troublesome since so many stations gave satisfactory signal-to-noise ratio. I did not make a note of the total number of stations heard, jotting down only those which came in either pretty well or excellently. "Pretty good" denoted a station which was heard



# Audio - Frequency Curve Tracer

## SIMPLE INEXPENSIVE METHOD USING A CATHODE-RAY TUBE

ONE method of obtaining the frequency response characteristic of an audio-frequency amplifier is to apply a constant voltage at a number of frequencies to the input of the amplifier under test and to measure the corresponding voltage outputs. The results may be plotted, point by point, on semilog paper. Although the equipment for this method is relatively simple, the process is tedious and time-consuming, particularly if the number of frequencies to be investigated is large.

Automatic recording equipment for tracing the frequency-response characteristic of AF amplifiers is available. The general principle of operation is to feed the output of an AF oscillator to the input of the amplifier under test, and to arrange matters so that the output of the amplifier operates a stylus which traces the frequency characteristic. The vertical deflection of the stylus should be proportional to the voltage output of the amplifier and the horizontal deflection to the logarithm of the frequency. In this type of equipment it is important that the frequency of the oscillator output voltage

By  
W. N. WEEDEN

should be proportional to the logarithm of the angular motion of the dial. In practice, this proportionality is maintained by providing means of calibrating the oscillator at a given point on the dial.

This article describes a simple inexpensive means for tracing automatically the frequency response characteristic of an AF amplifier on the screen of a cathode-ray tube. The only equipment necessary is an AF oscillator of conventional design, a cathode-ray tube, and a rectifier-amplifier system, shown in Fig. 1.

Referring to the circuit of Fig. 1, it will be seen that the output of the AF oscillator is connected to a resistance-capacity

network. The voltage across R is proportional to the output voltage of the oscillator and approximately proportional to the logarithm of the oscillator frequency. Hence, for constant oscillator output voltage, the voltage across R varies only with frequency, and is independent of the calibration of the oscillator. The voltage across R is rectified by one section of a 6H6; the rectified output is filtered by R<sub>1</sub>, C<sub>1</sub> and is applied to the input of a single-stage DC amplifier. The output of the amplifier furnishes the voltage of the horizontal plates of the cathode-ray tube. Thus, the DC voltage applied to these plates is proportional to the logarithm of the frequency.

### The Filter Circuit

The signal from the output of the amplifier under test is rectified by the second half of the 6H6; the rectified output is amplified by a 6J7 and the DC output of this valve is applied to the vertical deflecting plates of the cathode-ray tube. The vertical deflection of the spot on the screen is directly proportional to the output voltage of the amplifier under test. To operate the device it is only necessary to turn the oscillator dial through the frequency range of interest for the spot to trace the frequency characteristic of the amplifier.

The action of the resistance-capacity network is interesting. The values of components were chosen so that a curve of output voltage versus frequency is a straight line on semilog paper over the frequency range of interest. A measured voltage characteristic of the network is shown in Fig. 2. The characteristic is nearly a straight line from 20 to 10,000 c/s. The curve becomes flat outside

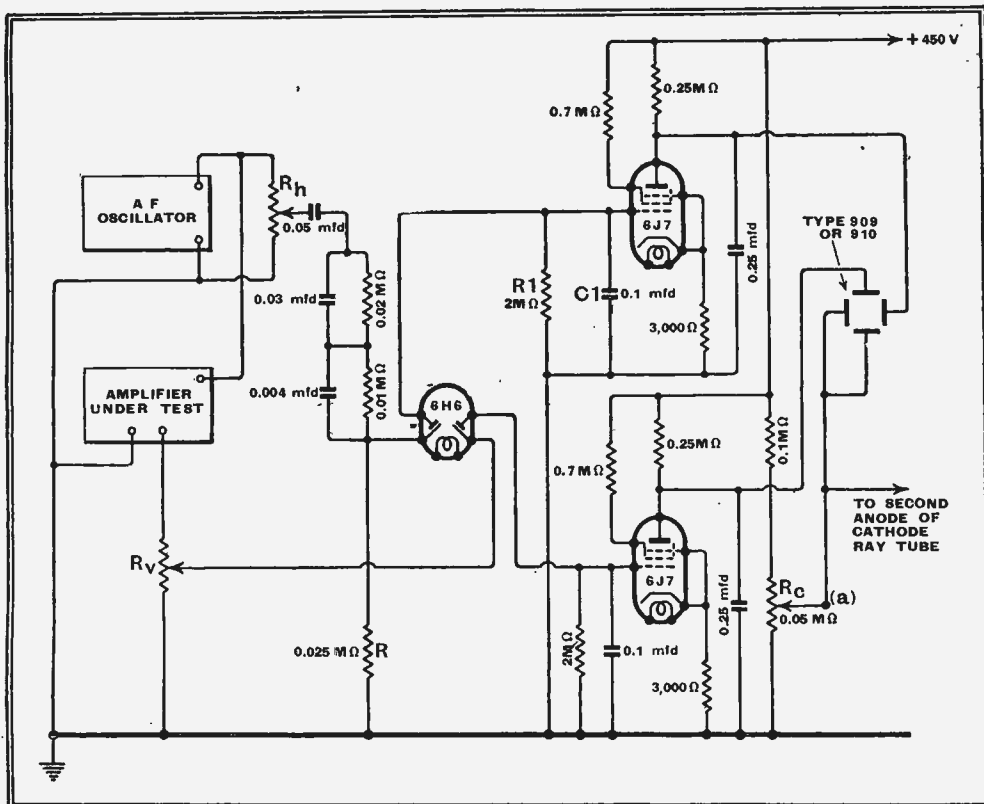

Fig. 1. When using this circuit the anode voltage of the cathode-ray tube is equal to that of its own power supply plus the voltage between (a) and earth. The CR supply tube must not itself be earthed.

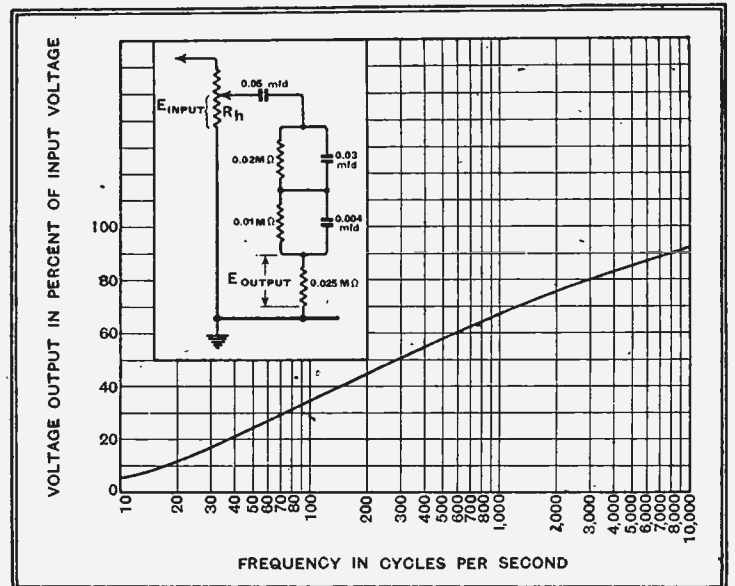

Fig. 2. The curve of output voltage plotted against frequency is shown here, the filter constants having the values marked.

**Audio-Frequency Curve Tracer—**

this frequency range, a condition which indicates constant deflecting voltage.

A screen with a long after-glow is used in the cathode-ray tube so that the entire trace can be observed for some time after the actuating signals are removed.

The time-constants of the DC amplifier restrict the time required to make a trace. When the oscillator dial is turned through a desired range too quickly the trace will not show rapid changes in output due, for example, to resonant conditions in the amplifier. For the values shown in Fig. 1

about 30 seconds is required to make a trace.

The oscillograms in Figs. 3(a) and 3(b) show typical results. Fig. 3(a) shows the effect of disconnecting the voice-coil of the speaker from an amplifier. Resonant frequencies are indicated by the peaks. Fig. 3(b) shows the effect of by-passing high audio frequencies with a tone control. Quantitative data may be obtained by calibrating the ordinate in terms of voltage and the abscissa in terms of frequency, as shown in these figures.

This curve tracer is suitable in the

laboratory for determining quickly and with fair accuracy the effect of changes in amplifier design. It is also suitable for production testing of AF amplifiers because of the relatively short time in which a characteristic can be obtained. A single test yields data on the gain of the amplifier throughout the frequency range of interest. The accuracy of the results is sufficient for most practical applications.

The circuit of Fig. 1 was developed by the RCA Radiotron Co., and it is through their courtesy that the writer can present it as well as the curve in Fig. 2 and the oscillograms of Fig. 3.

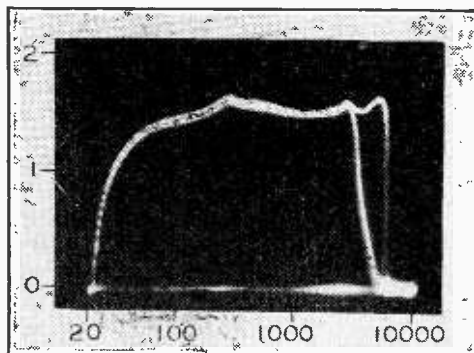
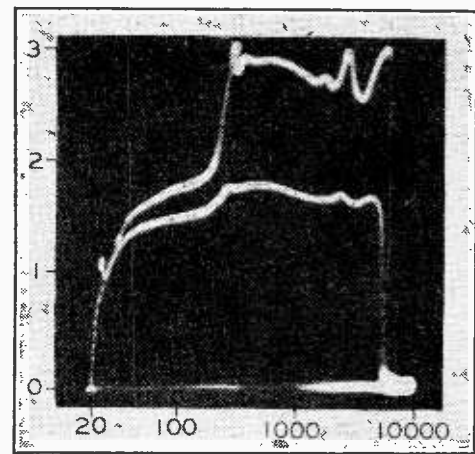

Fig. 3. The oscillograms reproduced here show left (a) the effect of the speaker on an amplifier and above (b) the effect of a tone control circuit.

**Wired Broadcasting**

THE German State Post Office is now beginning a service of RF wired broadcasting. Three wavelengths with three different programmes are sent out over the telephone network by the Gladenbeck system. The German radio industry has now for the first time brought out receivers for this purpose, which differ from the ordinary single-circuit receiver by the addition of a unit for connecting to the telephone network. In the future, special small adaptors will be on sale with the help of which any ordinary broadcast receiver will be usable for this purpose. The ordinary telephone service is in no way upset by the addition.

**Notes and News**

**A New People's Set in Germany**

THE Minister of Propaganda, Dr. Goebbels, announced in his opening speech at the Berlin Show that a further 332,000 People's Sets had been sold in the period between August 1st, 1936, and March 31st, 1937. In the same period 822,000 higher priced sets had been sold. He went on to say that a decision had been taken to manufacture a first series of 300,000 new and improved models of the People's Set. These will be sold at 15 per cent. less than the price of the original model. As far as the original model is still obtainable, it will now be sold to the public for RM. 59; the new model will cost in the neighbourhood of RM. 65, or £3 5s. at par.

**Standard Sets for Export**

It was further announced that the radio industry had placed a new joint production on the market for export only. This receiver is a five-valve superhet for short and medium waves, and is intended mainly for Germans overseas. The price will compare favourably with that of foreign sets sold in those countries.

**High Definition Television Abandoned**

The 729-line pictures which were successfully demonstrated

by the Fernseh A.-G. to the Press prior to the show were discontinued. A reason was not given, but it was understood to be entirely non-technical; it therefore seems possible that the high standard was thought likely to distract from the importance of the normal standard adopted. The pictures showed a slight flicker owing to the brilliance of the illumination of the screen, but they were otherwise perfect, giving great shadow detail.

**Marconi Memorial**

AT Wimereux, where Marconi transmitted his first message across the Channel, a memorial ceremony was held the other day, and the Mayor, M. Cacin, announced that a monument was to be erected there to Marconi and Prof. Branly by public subscription.

**Brussels Exhibition**

THE Belgian Radio Salon will be opened in the Palais du Centenaire from 4th to 13th September.

**Electric Eye at the Paris Exhibition**

PHOTO-CELL equipment has been installed at the entrance to the Paris International Exhibition with an invisible light beam to count the number of visitors passing through the gates.

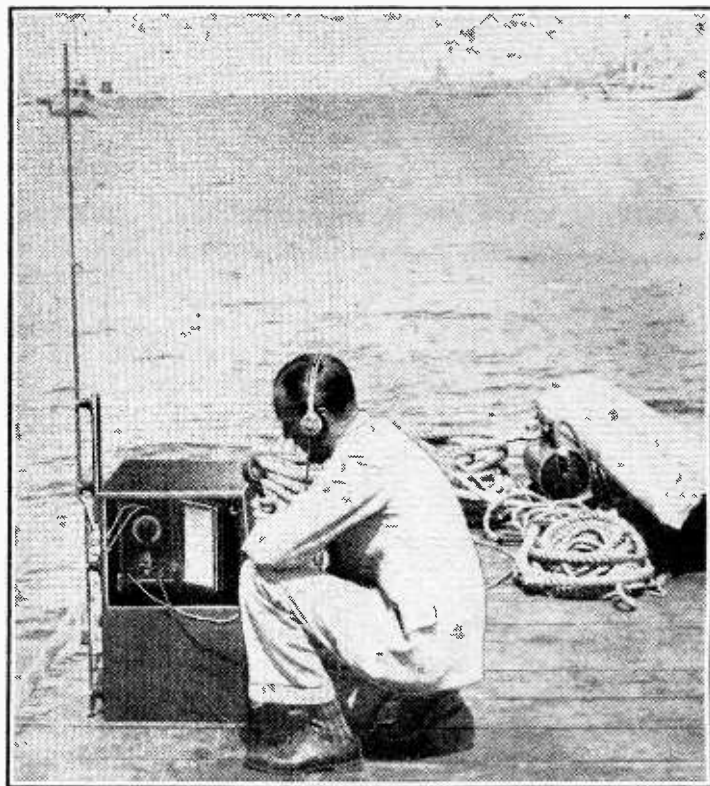

FOUR-AND-A-HALF METRE LINK. Used for sending and receiving messages between the embarkation raft and passenger speed boats at the Hythe seadrome, the Hermes Transreceiver seen is a watertight model.

**Nearly 4,000,000 French Listeners**

THE number of receivers declared in France on July 1st reached a total of 3,949,826, as compared with 3,926,902 on June 1st. It is expected that the four million mark will be passed in the early autumn.

**Index and Binding Case**

THE Index for Volume XL of *The Wireless World*, January to June, 1937, is now ready, and may be obtained from the publishers at Dorset House, Stamford Street, London, S.E.1, price 4d. post free, or with binding case 3s. 1d.

# German Radio Exhibition

**T**HIS year's Exhibition, the 17th in succession, was divided, like those of previous years, into a General Show and the Industry Exhibition. In the former, chief interest centred in the broadcast items of the various German State transmitters, which were carried out on platforms in two halls and also in the Funkturm Gardens. Besides these transmissions, the General Show included stands of the various German associations interested in broadcasting, and of the State Post Office with a very complete exhibit on interference suppression.

The industry was accommodated in five halls. There, naturally, most of the visitors congregated—their numbers exceeding all previous years, in spite of the early date of the Exhibition.

This year the German industry had developed the following types of receiver: 1-circuit with 2 valves, 2-circuit with 2 valves (reflex), 2-circuit with 3 valves, a few

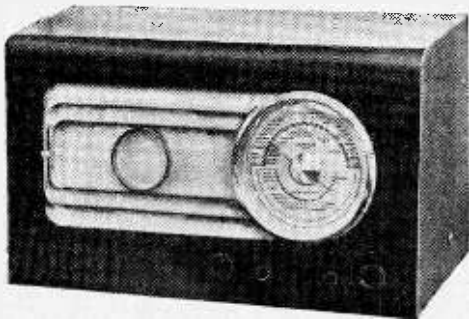

Schaub two-circuit three-valve receiver, Type 297 with RF and AF reaction.

3-valve superhets (including a 3-valve superhet with reflex circuit), superhets with 4, 5, 6-8 valves, to which total the non-amplifying valves must be added.

This year an important point is that for almost every AC type there is a corresponding Universal model; in all these an auto-transformer for AC is built in, so that on AC mains a sufficiently high anode voltage is available, while on DC the auto-transformer acts as a choke.

Much has been done in the field of battery receivers, and there are two superhets for battery supply. A new Olympia suit-case portable is shown, in spite of the fact that this type of set has never made much headway in Germany.

An important feature of this year's receiver production is a very considerable reduction in price, which is to be attributed largely to the 30 per cent. drop in valve prices.

Prices this year are roughly as follows: 1-circuit, 120-180 RM; reflex 2-circuit (2 valves), 189-196 RM; 3-valve 2-circuit, 160-200 RM; 3-valve superhets, 224-250 RM; 4-valve superhets, 230-290 RM; 5-valve superhets, 330-410 RM; 6-valve superhets, 360-510 RM; multi-valve superhets, 370-745 RM.

Radiograms and console models and Universal mains types are, naturally, higher in price.

It may be noticed that the greatest price reduction is found in the 2-circuit models and 4-valve superhets; in the latter case it amounts to nearly 25-30 per cent.

There are 23 single-circuit receivers for AC and 15 for "all-mains" (Universal)

offered this year. None of these has a short-wave band. A large output is provided in all cases, and except in three types, all 1-circuit receivers have a high-quality moving-coil loud speaker. Notable points are that this year's tuning scales are all easy to read, and that in some cases the aerial and reaction couplings are linked with the tuning control, so that, after finding a station, no final adjustments are needed.

Of three-valve types there are 14 AC models and five Universal, employing two tuned circuits. Of the two-valve reflex type there are two for AC and one Universal. No short-wave band is provided. Nearly all receivers have a fixed regenerative coupling, and all have good fading compensation. Since most of them are provided with one band-filter—some with two—band-width adjustment is provided.

Reflex 2-circuit models with two valves are produced by Schaub and by Körting for AC mains only, and without short-wave bands. The new "Novum 38" of Körting is particularly interesting, for it has fading compensation, visual tuning, and automatic selectivity control (obtained by making the permanently adjusted regenerative coupling vary with the signal strength). Two other knobs are provided; one of these acts simultaneously as volume control and as a push-pull on-off switch, so that on switching the set off the volume adjustment remains undisturbed ready for switching on again. This type of switch is used on nearly all the new receivers. The "Novum 38" has, in addition, a tone filter for the low and high frequencies. The bass is artificially boosted in the AF amplifier.

There are two three-valve superhets for AC, one each by Saba and Schaub (reflex);



Lorenz four-valve superhet, the lowest-priced set in this class.

each firm also offers a Universal model. They come in price quite close to the four-valve superhet, so that it may be assumed that they will soon be crowded out by the latter type. Each model uses duo-diode, and has a large output stage. Only the Saba model has a short-wave band.

The four-valve superhets number 41 for AC and 29 Universal operation. Except for two AC and four Universal models, all have a short-wave band. Most of them have six tuned circuits, a few five and a few seven. Fifteen sets are provided with tunable band-filters. With a single exception the first valve is a mixing valve; all use the duo-diode as detector following the IF amplifier, and in all models the last valve is resistance-coupled to the preceding valve.

## NATIONAL SHOW REVIEWED BY OUR SPECIAL REPRESENTATIVE

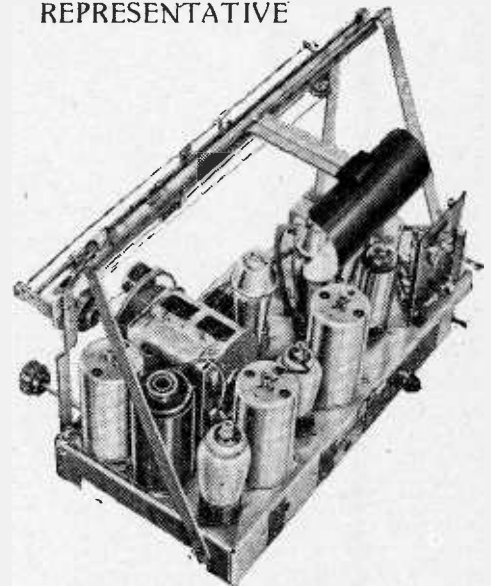

Blue Spot four-valve superhet with unit chassis construction to overcome vibration.

The IF is nearly always 468 kc/s; Philips use 128 kc/s throughout, and a few types employ 470-490 kc/s. All the models have automatic fading control, in most cases of high efficiency for short waves; most of them have visual tuning and band-width adjustment. Several four-valve superhets are provided with a tone-compensated volume control. In nearly all cases the variable-selectivity control is accompanied automatically by a tone-control adjustment. Many four-valve superhets are provided with a band-width variation in two band-filters. In the Philips four-valve super there is automatic tuning correction to the carrier wave.

In the five-valve superhet class seven tuned circuits are provided, with five main valves and four auxiliaries. They all have two IF band-filters and (except for one Siemens model) all possess a RF pre-amplifier valve. Only one output valve is provided. Short-waves are included in all cases. The intermediate frequency is 127 kc/s (Braun), 468 kc/s (Siemens), 476 kc/s (Ideal [Blue Spot]), 473 kc/s (Neufeldt and Kuhnke), and 468 kc/s (Mende); in the models by Ideal, Mende, and Neufeldt and Kuhnke, there is provision for adjusting to another IF if desired. Visual tuning, band-width regulation in two band-filters, tone and volume controls, as in the four-valve superhets, are, of course, included in the five-valve models, but to a greater extent. The Braun five-valve superhet is also available as a radio-gramophone.

The big superhet class embodies six to

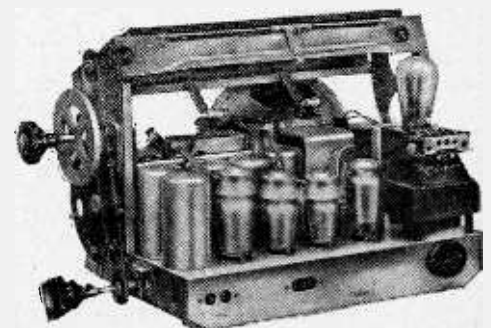

The Saba four-valve superhet 446 WLK.

**German Radio Exhibition—**

eight amplifying valves and up to six non-amplifying valves. In the six- and seven-valve sets there are up to eight tuned circuits, in the eight-valve sets up to ten circuits. Six-valve superhets are produced by Lorenz, Philips, Saba, and Sachsenwerk; seven-valve superhets by Ideal (Blue Spot), and Körting; eight-valve types by AEG, Loewe, and Telefunken. They all include

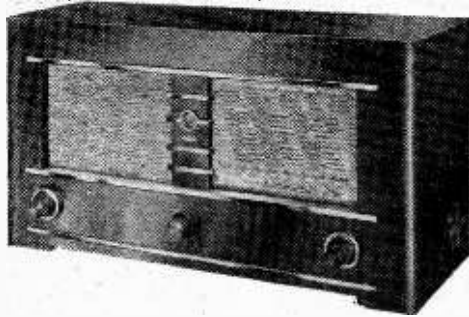

AEG Super 77.

short-wave reception. Automatic tuning correction is provided in the Körting seven-valve "Transmare 38" and the eight-valve superhets of AEG, Loewe, and Telefunken. "Touch" tuning is provided on the Philips "Aachen-Super D53" (six valves); the tuning knob rotation becomes partially checked when a carrier wave is encountered. Motor-driven tuning is found on the models by Saba (980 WLK) and Körting (Transmare 38). The big superhets of Körting, Blue Spot, AEG, Loewe, and Telefunken have two loud speakers. Philips employ a new loud speaker with a special cone.

Even in the 2-circuit sets, the "drum" tuning scale has been discarded in this year's receivers. The listener likes to be able to see all the station names at once, and practically all scales are now of the long rectangular type or, in some cases, of the clock-face pattern. On the Telefunken scales, close to the adjustment point of each station name, there are small rectangular black marks whose width depends on the

signal strength to be expected of each particular station. Marks against stations which can only be received with interference have one or two white lines across them to indicate that they suffer from one or two interfering stations. In this way the listener sees more or less what he may expect from each station.

**SOME TYPICAL RECEIVERS**

*Telefunken "Gross-Super 7,001 WK."*—This receiver has twelve valves and ten circuits; the output stage embodies two valves in push-pull, and they feed into two loud speakers. The band-width adjustment controls four band-filters, and there is a switch for varying to low or high tone characteristics. The response cuts off at 9 kc/s. QAVC is included as well as a tone-compensated volume control, and by no means least important, automatic tuning correction. This last device works on the same principle as in the "Gross-Super" of the AEG, the circuits being similar to the Telefunken model; IF voltage is taken from the two circuits of the last band-filter and led to a duo-diode discriminator. The DC voltage is taken, via a potential divider, to a valve which is in

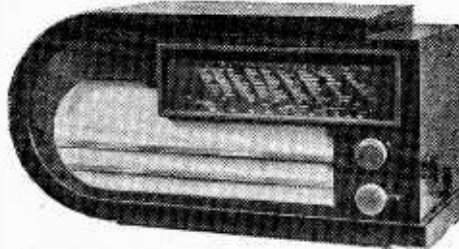

Octa 838, a superheterodyne by Loewe with many refinements and large output stage.

parallel with the oscillator tuning circuit, so that the frequency of the oscillator is affected by the variations of the impedance of the valve.

*Körting "Transmare 38."*—This receiver works either as long-distance superhet with seven amplifier and five other valves, four RF and four IF tuned circuits, and two

auxiliary circuits for automatic tuning correction; or as a "straight" receiver for local reception. For distant reception the band-width can be adjusted in several band-filters. The short-wave sensitivity is very high. Particularly interesting is the presence of a motor drive for tuning with press-



Körting "Transmare 38" which can be used either as a superhet, or a "straight" receiver for local reception.

button control. Buttons for twenty stations are provided, each closing one contact on the slide-way of a motor-driven carrier. The motor starts when a button is pressed, and the carrier moves to the right or left according to the position of the particular button, and always as far as the contact which has been closed. As soon as it reaches this, a relay is energised which stops the motor and switches the anode current on to the receiver. The motor also drives, simultaneously, the whole rotating condenser system. The rather rough tuning given by the motor device is finally adjusted by the automatic tuning correction (as in the Telefunken model) to the carrier wave.

*Philips Superhet.*—Novelties to be found in the Philips superhets are a specially effective "three-diode" circuit developed for the reduction of non-linear distortion. In the "Aachen Super D53" a contrast expander is included. Here the receiver has a negative-feedback coupling, tapped off the output circuit. In this feed-back circuit a resistance lamp is included as part of a voltage-divider. If the output energy is small (low volume from loud speaker) the lamp resistance is also small and the negative-feedback-coupling is very effective, so that the amplification is reduced. For increasing volume the lamp filament begins

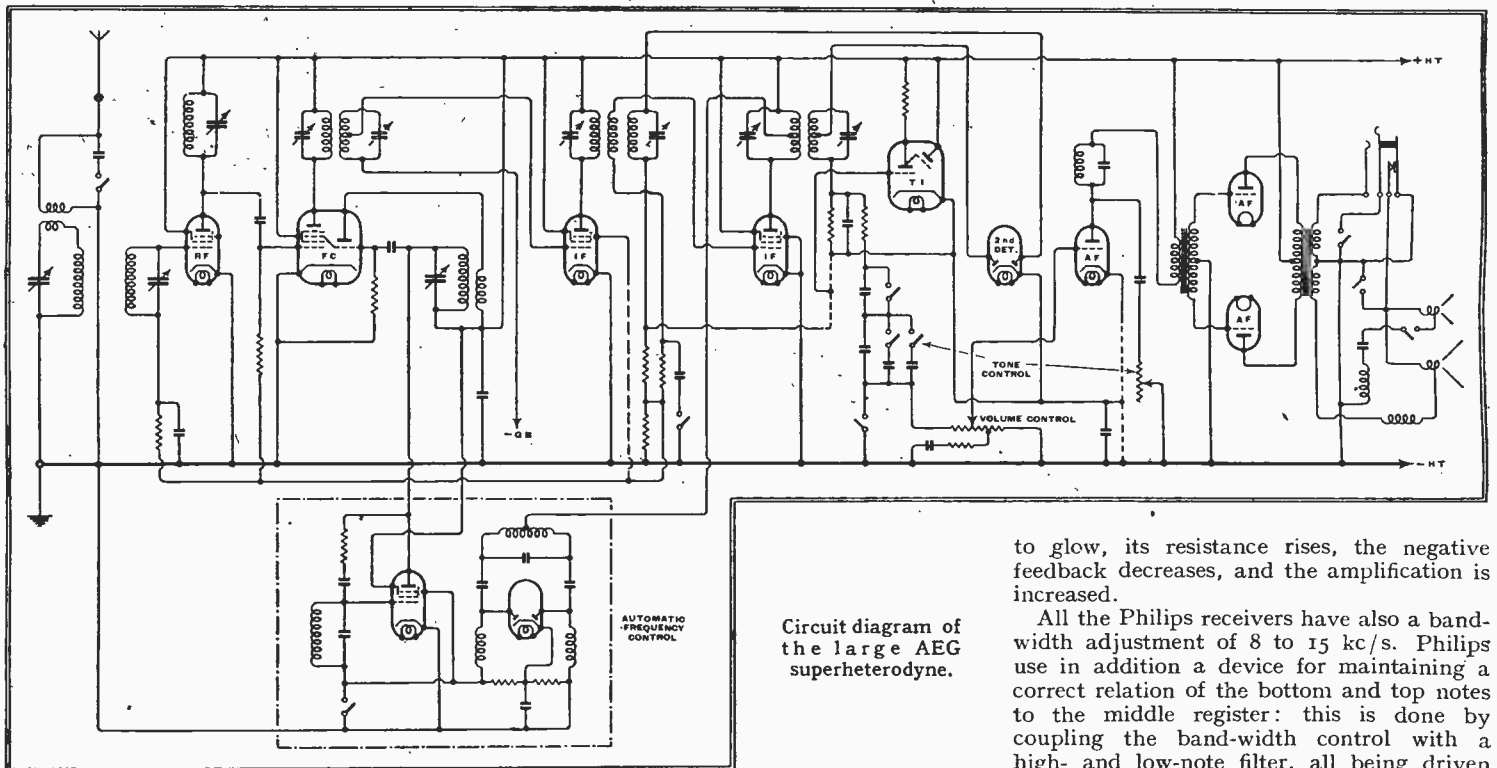

Circuit diagram of the large AEG superheterodyne.

to glow, its resistance rises, the negative feedback decreases, and the amplification is increased.

All the Philips receivers have also a band-width adjustment of 8 to 15 kc/s. Philips use in addition a device for maintaining a correct relation of the bottom and top notes to the middle register: this is done by coupling the band-width control with a high- and low-note filter, all being driven



**German Radio Exhibition—**

by a single knob, the "Monoknob." Any fall in sensitivity of the whole receiver, resulting from loose coupling in the IF band-filter, is counteracted by a gradual reduction of the negative feedback. In this way the overall sensitivity of the receiver

to the grids of two pentodes in push-pull, and the anode current of this push-pull stage is used to drive the motor. Normally, this motor receives only the steady current of these valves, and it will run to left or to right according to whether the position of the main switch of the receiver sends the

anode current in one direction or the other through the motor. The motor drives the ganged condensers. As soon as the scale pointer reaches the desired station name, the motor is first of all checked. According to the phase of the anode-current in the push-pull stage, the motor works itself into the position of resonance with the carrier wave, under the control of the amplitude of the carrier.

*Siemens "Chamber-Music 'Schatulle.'"*—A five-valve superhet with two non-amplifying valves and seven circuits. Intermediate frequency, 468 kc/s. In order to obtain high selectivity for distant reception and as wide as possible a frequency band for local reception, all the components determining the width of the receiver band are made variable. The input consists of

Circuit principle of the motor-driven tuning control of the "Transmare 38."

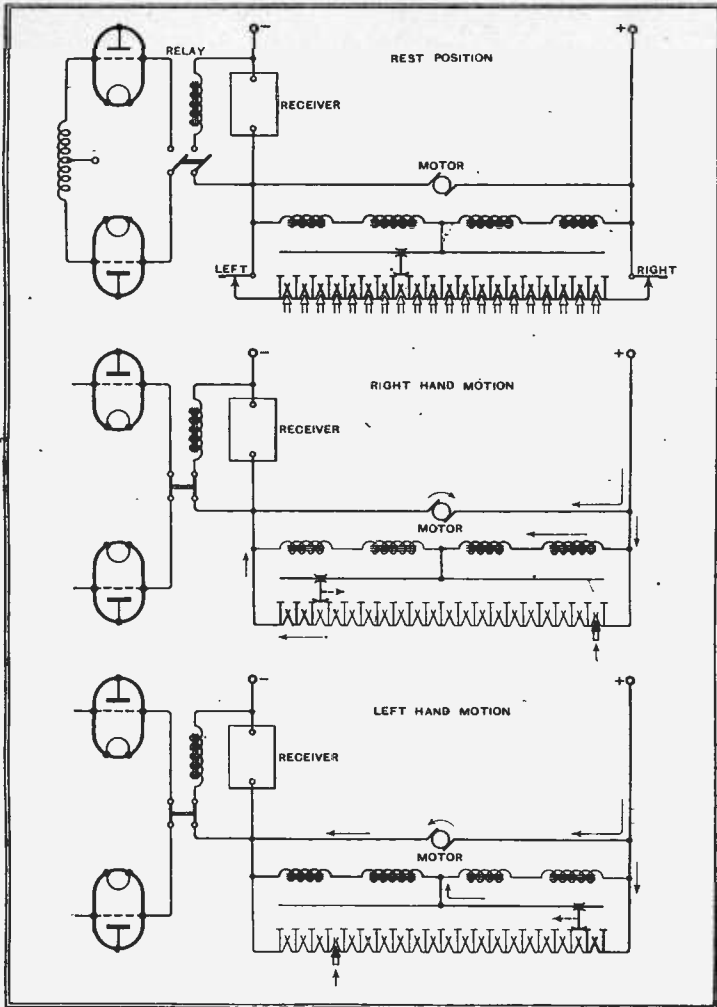

remains practically the same in all cases.

*Saba 980WLK.*—This receiver has thirteen valves, including non-amplifying valves, and nine tuned circuits. It has all the devices possessed by the Telefunken "Gross-Super," and in addition has motor-driven tuning, together with automatic tuning correction. This motor-driven tuning is accomplished as follows:—An IF voltage from the last IF band-filter is taken

two pre-circuits combined to form a band-filter giving a high degree of image-signal elimination; the coupling between the two circuits can be varied. Both filters in the IF portion are adjustable. The pre-circuit control and the coupling variation control of the IF band filters are linked to an AF tone control and combined mechanically with the wave switch so as to form a single unit. For the reception of local sta-

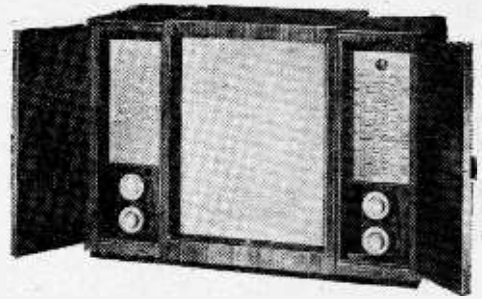

Siemens "Chamber Music" superhet, a receiver of unusual flexibility of control.

tions, all band filters are set to a band-pass width of 14 kc/s. Delayed AVC is provided. For exact tuning to the carrier frequency, this receiver (like most of the other German receivers which are provided with a visual tuning indication) is fitted with the Telefunken-Valvo "magic eye," whose triode portion is utilised for AF pre-amplification. By means of a tone-compensator the deep and high notes are brought up, and two loud speakers are provided, one for low and the other for high frequencies. On the "gramophone" side the high-frequency compensating circuit is disconnected in order to reduce needle scratch.

**COMPONENTS**

There is not so much to report on in the field of components as there has been in other years. In valves, an agreement has been come to between valve manufacturers and the German radio industry to bring out no new valves except the "magic eye" and the new 18-watt output pentodes. The former (Telefunken and Valvo) consists of a glass bulb with two valve systems, one above the other; the upper is the indicator system itself, the lower a triode with a high fixed "mu." Both systems are fed from a common cathode.

Telefunken have improved their gramophone pick-up "TO 1001" of last year. One can now turn the head to change the



New design of the Telefunken pick-up with permanent needle.

needle. Telefunken have also brought out a new loud speaker diaphragm which, owing to the corrugation of the materials, is quite loosely attached at its edge to the surround. Distortion due to diaphragm vibration is thus largely avoided. The size of the speech coil has also been increased to reduce distortion at large amplitudes.

The firm A. Cl. Hofmann (AKE) has turned out a new "revolving coil" for constructors, consisting of two discs, the upper one carrying the coils and the lower, stationary one, the switch contacts.

The well-known insulator works "Hescho" has this year again brought out a series of novelties: first, new ceramic coil formers on which the windings themselves are made of ceramic materials, silvered. Hescho have also produced new "Topf" (pot) condensers for high voltages and small condensers of high capacity consisting of little tubes mounted in an upright position

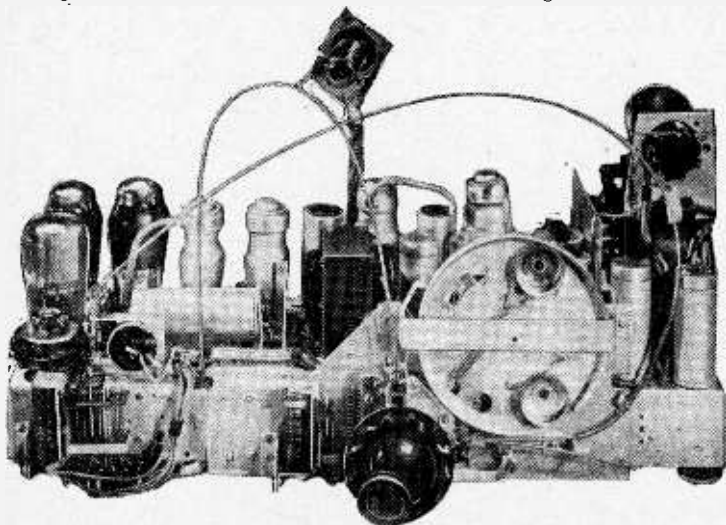

(Left) Philips six-valve superhet D53 with automatic tuning. (Right) Hescho Calit-mounted condensers.

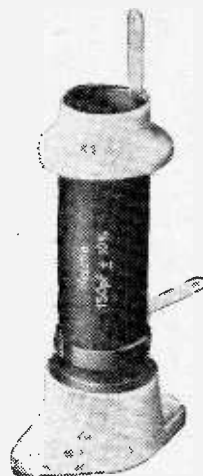

**German Radio Exhibition—**

and therefore well cooled by air; they also have copper tube welded joints and lead-in conductors through cylindrical and flat Calit walls, and many other exhibits, including a new insulating material.

Philips have a condenser microphone with built-in two-stage amplifier and built-in batteries, also a new universal measuring bridge for measuring resistance, capacity and inductance; in this the zero-indicating instrument takes the form of a glow-discharge tube.

The firm Leybold-von Ardenne exhibit



New universal measuring bridge by Philips.

their new cathode-ray oscillograph with their new tubes in which the foot is made of ceramic material and the 5 cm. fluorescent screen is flat.

Hermann Grau (Hegra) have a rectifier using a "cold" cathode; this is not heated

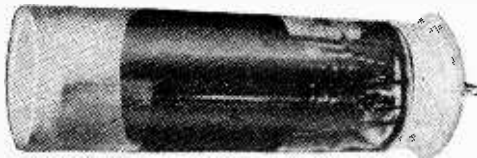

Leybold-von Ardenne cathode-ray tube.

by an external electric current, but is brought to incandescence by the discharge.

**TELEVISION**

Germany has now gone over to a new television transmission standard, with 441 lines interlaced scanning and 50 frames.

Telefunken shows for the first time an arrangement for the cheapening of television reception. The "block televisior" enables a whole block of houses to make use of a common pre-amplifier, so that individual subscribers only require the cathode-ray tube portion of the equipment. The sound programme is obtained through the AF circuits of the ordinary broadcast receiver, which it is assumed everybody already has.

Telefunken show a home televisior FEVI giving a 21 x 26 cm. picture, seen in a

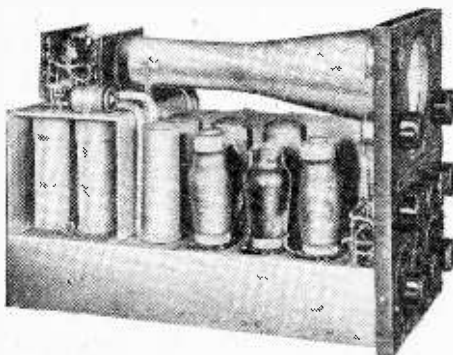

The new Philips cathode-ray oscillograph.

mirror. The circuit includes three valves for picture and sound together (pre-amplifier stage and oscillator of a superhet receiver) and then, separately, four valves and detector for the picture (band-width 4 Mc/s) and three valves and detector for sound (band - width 30 kc/s). The scanning unit has four valves and two rectifiers. The set will work with 375 and 441 lines.

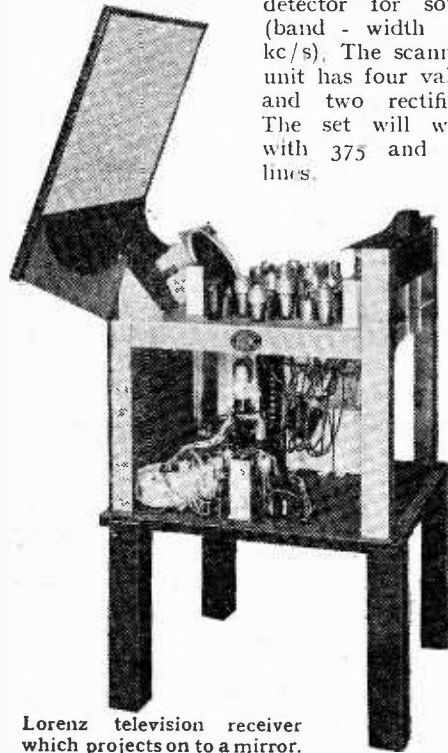

Lorenz television receiver which projects on to a mirror.

Telefunken also show a large-image projector equipment for projecting the head of a speaker before a large audience. This equipment uses 174 lines, which is quite enough for the portrayal of a single person. One cathode-ray tube is used for scanning and another for projecting to give a 1 m. x

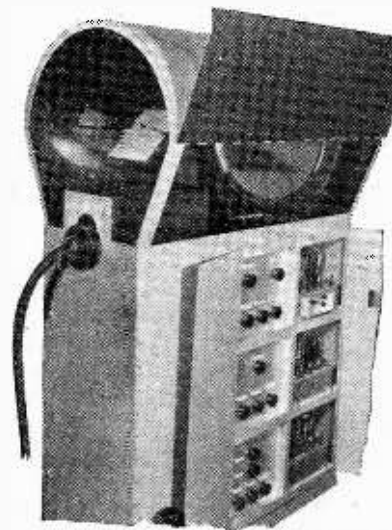

Telefunken large screen projection equipment.

1.5 m. picture of extraordinary brightness.

Telefunken also show television "fade-in" equipment for "continuous" television, in which three different television transmissions can be made at the same time. The equipment includes a control desk. Telefunken no longer scan with the Nipkow disc, but employ a lens-wheel.

Lorenz has brought out a much smaller home televisior than last year's. This includes a large-surface cathode-ray tube which is viewed directly. Lorenz has also

developed a new home receiver in which the cathode-ray tube is mounted in the front corner of the cabinet. From here the image is projected to a mirror on the inner side of the cabinet lid, which is lifted for viewing.

Finally Lorenz has developed new large-image projector equipment: in this a ring lens with mirror is mounted round the tube, close to the fluorescent screen. This combination of ring lens and mirror acts as a projecting lens, and the image is projected backwards in the axial direction of the tube, towards the cathode. In spite of the shadow effect of the valve body, the loss of light is not large, especially as the projection is from the much brighter inner side of the fluorescent screen of the tube.

The Fernseh A.G. has brought out two new types of television cameras, one (a

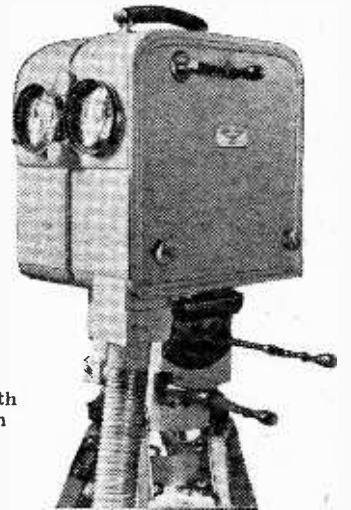

Farnsworth television camera.

heavy type) for stage use, the other, more portable, for outside broadcasts. Both employ the Farnsworth tube. There is also a new projecting receiver for a 1 m. x 1.2m. picture, and a home projecting receiver. Fernseh have a home televisior built into a cabinet which also contains an ordinary broadcast receiver and a loud speaker. A further novelty is the small, portable, intermediate-film scanner for outside programmes. Fernseh formerly used the Nipkow disc for film scanning, but now they have a new film scanner with Farnsworth tube. Fernseh also have an experimental arrangement for 729 lines, interlaced scanning, which gives astonishingly clear pictures.

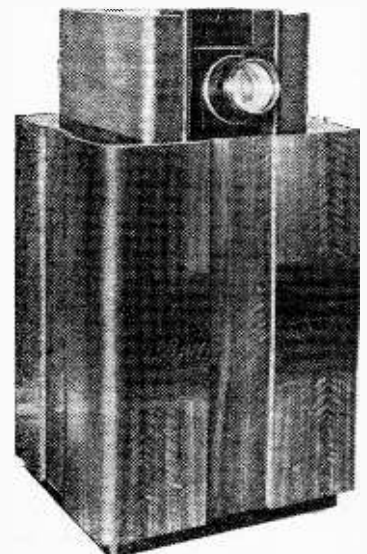

Projection television receiver by Fernseh for pictures 1 m. x 1.2 m.

# Measuring Mutual Conductance

ACCURATE DETERMINATION WITHOUT  
EXPENSIVE INSTRUMENTS

By PAUL D. TYERS

VERY considerable interest is now taken in the examination of valve performance. This is evidenced by the large number of valve testers which have recently been placed on the market. Opinion seems to be divided as to whether one should measure a definite scientific constant of a valve or carry out some form of test which is an indication of the cathode emission. It is not proposed to discuss the merits of the two systems, and the present article is confined merely to a simple method of measuring mutual conductance. Knowledge of the mutual conductance of a valve is of far greater utility than that of the available emission. Whatever design work is undertaken, no progress can be made until the constants of a valve are known, and accordingly every serious experimenter must have available some means for checking the mutual conductance.

The parameters of a valve can be measured either under static or dynamic conditions. Dynamic methods generally involve some form of balanced circuit in which the measurement is carried out under AC conditions. Static measurement of mutual conductance is very convenient. Mutual conductance by definition is the ratio of change of anode current with respect to change of grid voltage. The obvious system of static measurement is that of measuring the anode current, varying the grid voltage, and reading the corresponding change in anode current.

It is interesting to examine the limitations of so simple a method. First of all the mutual conductance of a valve is generally rated at zero grid voltage and low anode voltage, something of the order of 100 volts being normal. If we examine the characteristic curve of a valve taken under these conditions the available grid base is very small. If we apply a large voltage to the grid we immediately tend to operate on the lower bend of the valve, and the change in anode current will then be a function of the absolute grid voltage because the law will not be linear. This condition immediately necessitates the use of a fractional grid voltage such as 0.5 volt.

If the valve has a fairly low mutual conductance of the order of 2, then the change in anode current will be of the order of 1 milliamp. To obtain an accurate reading we must employ a meter on which we can read with some precision a change in current of the order of 1 milliamp., while our input voltmeter on the grid circuit must have a correspondingly high degree of accuracy. There is little difficulty in reading a current of the order of 1 milliamp. on a fairly inexpensive meter, but, unfortunately, there is the standing current of the valve, which in the case of a power valve may be anything of the order of 30 or 40 milliamps. This difficulty can be overcome by using a local circuit with a backing-off current in which the steady current of the valve is balanced out through the meter. We can then use a meter in the anode circuit which has a full-scale deflection of the order of 5 milliamps. This would be suitable for valves having a conductance from about 1 up to 10. Even if we do this we are still faced with the necessity of measuring very accurately the half volt applied to the grid.

The half volt could be accurately determined by using a comparatively high voltage with a potentiometer and a high-range voltmeter with a reasonable accuracy. The method outlined, however, neces-

sarily involves two accurate meters, and for this reason it is not one which would appeal to the average experimenter, nor is it a system which appears to justify permanently connecting two expensive meters for occasional use.

The method outlined below obviates the use of any accurate instruments whatever, as the value obtained is independent of the meter reading. The accuracy depends almost entirely upon the calibration of a single variable resistance. It is unnecessary to point out that it is easier to obtain a far higher degree of accuracy in the calibration of a resistance than it is in the case of a meter. For a comparatively few shillings it is possible to produce a calibrated resistance with an accuracy far better than 1 per cent., and accordingly the system has much to recommend it.

The basic circuit is shown in Fig. 1. This was originally described by Professor E. V. Appleton in *The Wireless World* of November, 1918, and the present system is based entirely upon this arrangement. The valve V has on the negative HT circuit a milliammeter M. The grid of the valve is returned to the negative HT line through a resistance R. The voltage on the anode is that due to the battery E, while the grid is at substantially zero potential. Actually a minute bias is developed owing to the voltage drop across the milliammeter winding. When the switch S is closed a negative bias is applied to the grid from the battery B. This reduces the anode current registered by the meter M. At the same time, however, a local circuit is set up consisting of the battery B, the resistance R, and the meter M. The magnitude of the current in the local

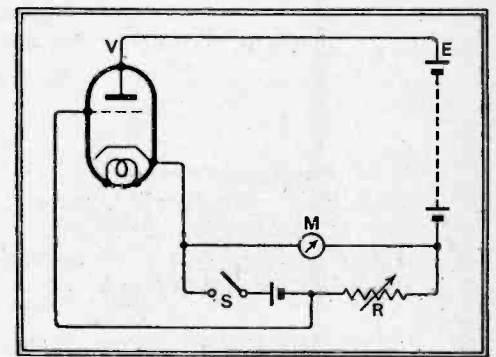

Fig. 1. — The original "slopemeter" described in *The Wireless World* of November, 1918.

circuit is obviously controlled by the value of R. This local current flows in the opposite direction to that due to the change in anode current. It follows, therefore, that there must be some setting of the resistance R at which the local current is exactly equal and opposite to the change in current due to the alteration of bias.

## Indication of Conductance

What we really require to measure is the actual change in current due to the applied grid voltage. This change in current, however, we have shown to be equal to the local current. Now the local current bears a definite relation to the absolute value of R, and accordingly it should be possible to find some calibration of R which is proportional to the mutual conductance. By definition the conductance

$$g = \frac{\delta I_a}{\delta E_g}$$

If the change in anode current is  $i$ , then

$$g = \frac{i}{\text{charge in grid volts}} = \frac{i}{Ri} = \frac{1}{R}$$

We see, therefore, that the conductance is equal to the reciprocal of the resistance.

*MEASUREMENT of the mutual conductance of a valve by the classical method involves the use of two comparatively expensive meters; the author of this article shows how a single milliammeter in conjunction with a calibrated variable resistance may be used for the purpose.*

**Measuring Mutual Conductance—**

Two very important points should be observed. In the first place the conductance is no function of the accuracy of the meter. Providing that the meter is not sluggish it is possible to observe the most minute flicker and thereby determine a

change which is far smaller than one which could be read with any accuracy if one had to make a calculation from an absolute reading. The second point is that the reading is absolutely independent of the battery voltage, because the battery voltage controls both the local current and the change in anode current. It is very easy to see

that if we require to measure conductances having values between 1 and 10, all we require is a calibrated 1,000-ohm resistance.

It is interesting to consider how the basic circuit in Fig. 1 can be satisfactorily applied in practice. The first difficulty which arises is that with a valve containing a screen circuit. The screen current changes with applied grid voltage and accordingly if the method in Fig. 1 is used the screen current must be completely separated from the anode circuit. This necessitates the arrangement in Fig. 2, in which use is made of two high-tension supplies.

**Providing Grid Voltage**

Neither the arrangement of Fig. 1 nor Fig. 2 will really satisfy the desired operating conditions unless the battery has a voltage of the order of 0.5 volts. It is very clear that the simple circuit must be elaborated in some way or another. The arrangement in Fig. 3, devised by the writer, has been found to overcome all the difficulties, and at the same time give a high degree of accuracy. The only complication is the use of two grid cells, but the circuit satisfies the necessary conditions, that is, it separates the anode and screen current, and it also applies a small voltage to the grid which we have seen is necessary.

B1 is a large size  $1\frac{1}{2}$ -volt grid cell which, when the switch is closed, is shunted by a potentiometer R1. This consists of two resistances which give a 2:1 ratio, thereby applying 0.5 volt to the grid of the valve. B2 is a similar grid cell and forms a local circuit through R2 when the switch S is closed. It will be observed that the anode current meter is now in the anode circuit only and no other currents flow through this instrument. It might be argued that a serious objection to this circuit is the use of two batteries which, if they are not of the same voltage, will introduce appreciable error. This argument is correct

basically, but in practice it is found that the voltage of the two batteries drops substantially at the same rate. Moreover, the voltage drop is exceedingly small because the current which is taken is quite low and use is made of large-sized grid cells. The only effect of falling voltage

will be that of decreasing the sensitivity of the system, and providing that both voltages fall at the same rate the accuracy remains constant. Attention is drawn to a further resistance R3, in shunt with the meter. The meter employed is preferably one which has a full-scale deflection of the order of about 1 milliamp. R3 is

a variable resistance of low value of the order of 15 to 20 ohms, which is adjusted until somewhere about three-quarters or full-scale deflection is obtained with the particular valve which is being tested.

The calibration of R2 depends upon the voltage ratio of the potentiometer R1. If this is arranged to give a 2:1 ratio so that 0.5 volt is applied to the grid it is obvious that the conductance will then be  $\frac{3}{R}$ . The resistance to measure con-

ductance between 1 and 10 should therefore have a value of 3,000 ohms. In order to obtain a useful working scale a reciprocal law is desirable which will give a linear scale. In practice, however, a log law is preferable, because this opens out the scale between 1 and about 4 or 5. It is over such zones that small variation in conductance is particularly interesting, as this covers the values of most modern radio-frequency valves and small triodes. There is no objection to using a close scale between 7 and 10, which is representative of values of output pentodes and similar types of valves.

There are two points which require attention. It is rather important to decouple the anode and screen circuits by

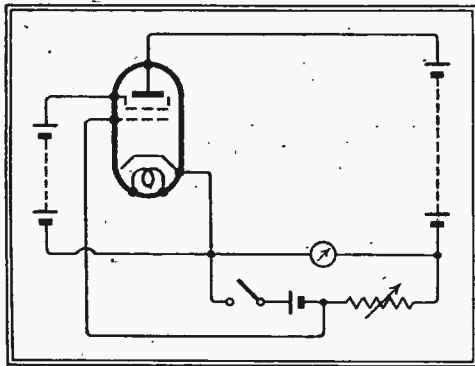

Fig. 2.—To measure the mutual conductance of an SG valve, a separate source of voltage must be provided for the screen circuit.

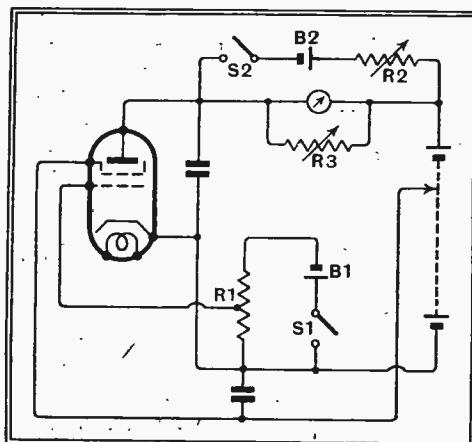

Fig. 3.—Practical arrangement for measuring mutual conductance as devised by the author.

shunt capacities, particularly if the leads are of appreciable length. It is also essential to use good switches. High resistance contacts will give very indefinite readings.

The instrument can be used in two ways. A valve can be inserted and R3 is then adjusted until about full-scale deflection is obtained. If desired, it can be adjusted until some definite reading on the meter is reached.

The two switches can then be simultaneously closed and R2 adjusted until the previous reading is obtained. Another system of working is to adjust R3 until the meter takes up any arbitrary position, and then rotate R2, simultaneously opening and closing the pair of switches until no flicker of the meter is observed as the circuits are opened and closed.

## News from the Clubs

### Golders Green and Hendon Radio Scientific Society

Headquarters: 60, Pattison Road, Hampstead, N.W.2.

ON September 12th the Society is holding a 5-metre competition, the objects being first to receive correctly at specified positions code words sent out by a transmitter whose position is unknown, and secondly to locate the transmitter with DF apparatus.

Those wishing to participate in this event, which is open to all interested in the ultra-short waves, should communicate with the Organising Secretary at the Headquarters before August 30th next.

### The North-West Kent Radio Society

Hon. Sec.: Mr. W. T. G. Wanden, 10, Walsingham Road, St. Paul's Cray, Kent.

The above held its inaugural meeting at the Scouts Hall in Grassington Road, Sidcup, on July 27th, when a representative body of amateur transmitters and short-wave enthusiasts decided that such a Society would serve a useful purpose and meet with support in the district. A committee was appointed to formulate rules and arrange for future meetings, the first of which was held on August 10th.

### The Thames Valley Amateur Radio and Television Society

Hon. Sec.: Mr. James N. Roe, 19a, The Barons, St. Margaret's-on-Thames.

Appreciating the value of close observation on the 5-metre amateur band from summer to winter conditions, the 56 Mc/s group of the Thames Valley Amateur and Television Society have organised a listening contest to take place over a period of six months. Reports will be sent to amateur transmitters active on these frequencies, and their co-operation in confirming reception will be appreciated. All the members of the Society's experimental group interested in ultra-high-frequency work are holders of transmitting licences.

### West Country 5-Metre Test Signals

During the week-end of August 21st-22nd signals will be transmitted from stations on many vantage points, including Snowdon, the Dublin and Mourne Mountains. The tests, which are for the purpose of discovering if it is possible to cover longer distances during the hours of dusk and darkness, will start at 8 p.m. on Saturday, August 21st, and continue from 10 a.m. to 8 p.m. on Sunday. Logs of reception should be sent to J. N. Walker (G5JU) at 4, Frenchay Road, Downend, Bristol.



# British and German Television

## IDEALS AND IDEAS

By L. MARSLAND GANDER

A VISIT to the Berlin Radio Exhibition this year is encouraging and stimulating to the television enthusiast, because the show is essentially a vast expression of faith. I, who feel a missionary zeal in the matter, am conscious that though there are many in Britain who share my belief in the future of television, there are also the doubters, and some in high places.

Undeniably, the public here has been slow to buy, and in my view the reason is simple enough, that the average listener remembers and perhaps misapplies the lessons of wireless, always expecting something better only just round the corner. But the powers-that-be hesitate to make further grants for television until set sales reach a more substantial total. Are they justified in such an attitude?

In Germany the position is totally different. Not a single set has been sold to the public and there is considerable doubt still regarding the immediate commercial prospects. Though the new standard of 441 lines, interlaced, at fifty pictures a second has been universally adopted, and the pictures which I saw in the exhibition are quite as good as those of the B.B.C., none of the sets shown in the exhibition halls have been priced.

Yet everywhere there is evidence of the huge expenditure by the State on television research, and the final item in a bill which has been mounting for eleven years is the cost of constructing three stations to the new 441 line standard. Two of these new stations are to be on mountainsides, one on the Brocken, in the Harz Mountains, about 120 miles from Berlin, and the other on the Feldberg, a lesser known peak near Frankfurt. The third transmitter will be

German television control and mixing desk for a single channel transmitter.

in the old Witzleben tower, which is in the Exhibition grounds.

Obviously, the State must be supporting the research work of the various television companies, chiefly Telefunken and Fernseh, so that the equivalent of the large sums spent here by private enterprise have also come out of the public purse in Germany. A two-fold question arises: How is the money collected and why is it being spent on such a liberal scale?

### Larger Licence Revenue

In answer to the first question it must be remembered that the German listener pays 2 marks a month for his licence. There are 8,300,000 listeners in Germany, and even allowing for the 500,000 free licences, the considerable sum of 187,000,000 marks a year is realised from this source. Conversion to sterling is misleading because the official rate of 12 marks to the £ appears to bear no relation to the purchasing power of the mark. However, conversion at the par rate of 20 to the £ still allows £9,000,000 for comparison with the £4,000,000 raised by the B.B.C. licences.

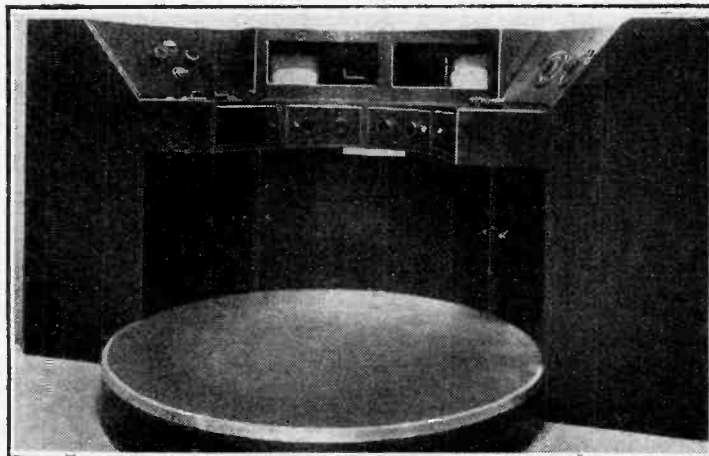

I understand that about half the sum realised goes to the German Post Office, and the other half, approximately, to the broadcasting organisations. This, then, is the potential source of the television expenditure.

Why the money is being spent, without the prospect of early commercial rewards, is a more difficult question to answer. Yet, I think, the principal reason is simple enough and rests in those two words, National Pride. The New Germany must be second to no other country. She must have the finest roads, the best equipped Army, Navy, and Air Force in the world. So German television, a mere incident in Nazi policy, must also be the best in the world, whatever the cost.

As America had adopted 441 lines, Germany had to equal it or do better. As Britain had a public television station, Germany must have three. On the whole, the 441-line picture is no better, in my judgment than the 405-line picture, but it would have been fatal to national pride to have a picture with fewer lines than the American standard.

There are, of course, other considerations. The German Air Force is known to be taking an active interest in television development. How far advances have been made in the picking up of pictures from the air is a carefully guarded secret, but the possibilities of such a development in warfare need no emphasis.

### Progress as Propaganda

The Nazi State must always make fresh offerings to its subjects as a demonstration of its inherent virtue. Television is such an offering and is shown in the various public booths throughout Berlin. An improved standard of transmission will increase the entertainment value of these public demonstrations and provide the public with further proof of the beneficence of the régime. Already, I am told, there are regular "fans" at some of the booths extracting amusement from the 180-line pictures at 25 a second. Though by B.B.C. television standards the German programmes are so poverty-stricken that I cannot imagine an English audience obtaining any satisfaction from them whatever.

As a sidelight on Nazi pride I may mention that my visit to Berlin and report in

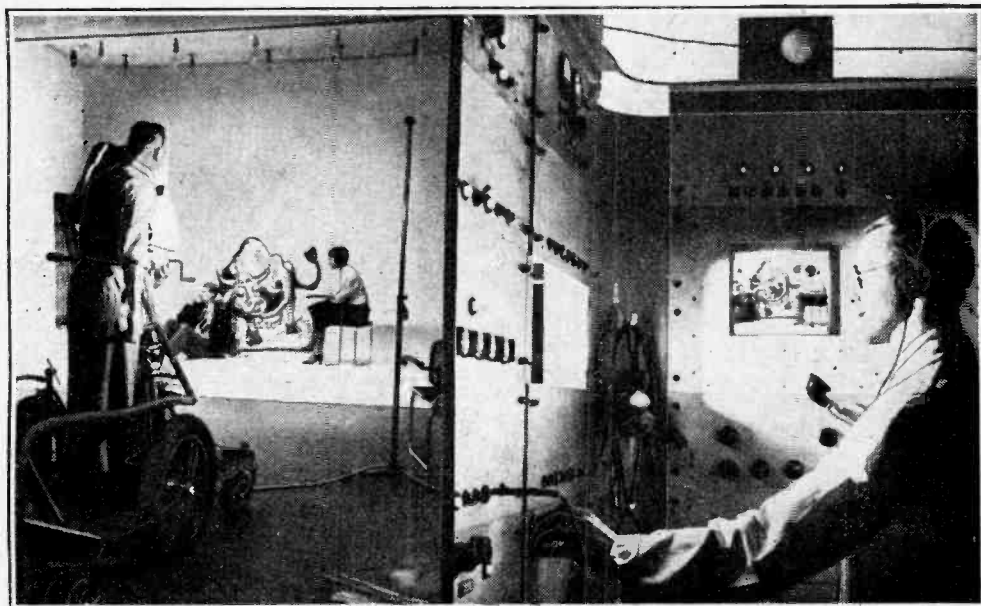

Television demonstration at the Berlin Show. A studio scene appears on the left, with controls of the transmitting station on the right.

**British and German Television—**

*The Daily Telegraph* on the Show was regarded as such a tribute to German achievement that it was not only quoted in Berlin broadcasts throughout the following day, but was also reproduced widely in the Press. Actually I paid a qualified tribute, but the German Press translated it into something far more handsome.

As regards the commercial prospects of television, naturally they are not entirely disregarded in the German calculations, but when I asked Dr. Goerz, head of the television section of the Reichspost, when sets would be available to the public he was extremely guarded in his reply.

"England has been disappointed with the public response," he remarked. Nevertheless, the impression exists that sets will be offered for sale soon.

Another reason for German interest in television is in its application as a visual extension of the public address system for great political gatherings. Apparatus was shown, working on a 150-line standard, which enlarged a speaker's face on to a screen measuring about four feet square. This particular piece of apparatus is operated in semi-darkness, the source of light glowing dully like the setting sun.

I myself stood in the position of the orator

and saw my image reflected into a mirror. The standard of reproduction is not particularly satisfactory at present.

Germany has not built a mobile transmitting unit working on the new standard, such as the B.B.C. have used for the Wimbledon tennis and the Coronation procession. But I saw a picture reproduced from the grounds by camera and land line which was exceedingly good. It seemed to my eye, in fact, somewhat better than the picture seen on the monitor panel inside the B.B.C. van. I am aware, however, of the difficulty of carrying a picture impression in one's mind for comparative purposes and make the comment with due reserve.

I imagine that such a mobile unit will soon be evolved in Germany in order to show viewers the magnitude of Nazi political demonstrations, Army and Air Force parades.

Meanwhile, in this country the Postmaster-General has not turned down the possibility of granting further sums for television development, presumably out of B.B.C. licence revenue. Those who believe in television and in British democracy will hope that a new science may find at least as much support from our own Government sources here as in the Totalitarian state.

In Next Week's Issue

## The Wireless World

## STRAIGHT SIX

A Sensitive High-quality Receiver  
Designed for Use with a  
Push-Pull Amplifier

**A**LTHOUGH the superheterodyne has for long been almost universally employed for long-distance reception, recent development has shown the straight set to have many advantages, especially for home construction. Complete freedom from self-generated whistles and remarkably easy ganging are the chief points in its favour.

*The Wireless World* Straight Six is essentially a quality receiver and is designed for use with the Push-Pull Quality Amplifier or other amplifiers of similar design. Three RF stages are used with four tuned circuits and give all the gain and selectivity normally required. The diode detector provides distortionless AVC and feeds into the triode AF stage which is followed by a phase-splitting valve for providing a push-pull output.

A selectivity switch is provided so that the selectivity can be reduced to a degree permitting the attainment of the highest standard of quality when interference conditions are suitable, as in local reception. The receiver covers the medium and long wavebands and the manual volume control is operative on both radio and gramophone.

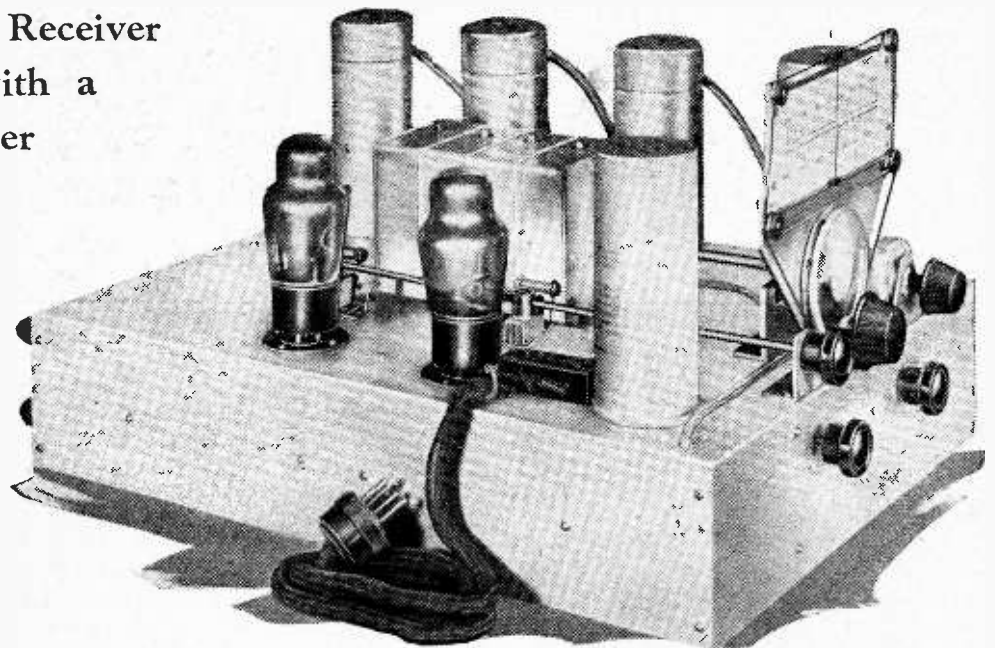

## THE LIST OF PARTS REQUIRED.

- 1 Variable condenser, 4-gang Polar "Midget"
- 1 Dial Polar VP Horizontal Drive
- 4 Inductance coils R.I. "Micron" BY36
- 1 Aerial coil B.T.S. "ML/FTA"
- 1 Volume control, tapered, 0.25 megohm Ferranti "PG"
- 2 Resistance boards, 10-way Bulgin C32
- 3 Valve holders, 7-pin (without terminals) Clix Chassis Mounting Type V2
- 3 Valve holders, 5-pin (without terminals) Clix Chassis Mounting Type V1
- 4 Valve screens B.T.S.

**Condensers:**

- 1 0.01 mfd., tubular, 350 volts DC working Dubilier 4421/E
- 5 0.05 mfd., tubular, 350 volts DC working Dubilier 4422/E
- 9 0.1 mfd., tubular, 350 volts DC working Dubilier 4423/S
- 2 0.0001 mfd., mica Dubilier 690W
- 1 0.0003 mfd., mica Dubilier 690W
- 3 5 m-mfds., ceramic dielectric  $\pm 5\%$  Dubilier CCE
- 1 10 m-mfds., ceramic dielectric  $\pm 5\%$  Dubilier CDS3
- 2 50 mfd. 12 volts, electrolytic Dubilier 3016
- 1 8-8 mfd. 500 volts peak working, electrolytic Dubilier 9203E

**Resistances:—**

- 2 50 ohms,  $\frac{1}{2}$  watt Claude Lyons
- 1 400 ohms,  $\frac{1}{2}$  watt Erie
- 8 500 ohms,  $\frac{1}{2}$  watt Erie
- 3 2,000 ohms,  $\frac{1}{2}$  watt Erie
- 1 5,000 ohms,  $\frac{1}{2}$  watt Erie
- 2 10,000 ohms,  $\frac{1}{2}$  watt Claude Lyons
- 1 20,000 ohms,  $\frac{1}{2}$  watt Claude Lyons
- 2 25,000 ohms,  $\frac{1}{2}$  watt Claude Lyons
- 2 50,000 ohms,  $\frac{1}{2}$  watt Claude Lyons
- 2 2 megohms,  $\frac{1}{2}$  watt Claude Lyons
- 2 2 megohms,  $\frac{1}{2}$  watt Erie
- 1 7,500 ohms, 3 watts Claude Lyons
- 1 9,000 ohms, 3 watts Claude Lyons

- 6 Switches, SPST Bulgin S80B
- 1 Switch Bulgin S81B
- 1 Switch, DPDT Bulgin S114
- 3 RF chokes Kinva Standard Type
- 1 RF choke Bulgin HF8
- 1 Cable, 5-way, with twin 70/36 leads and 5-pin plug Goltone
- 1 Connector, 4-way Bryce 5C2
- 3 Plug-top valve connectors Belling-Lee 1175
- 4 Lengths screened sleeving Goltone
- 6 Terminals, ebonite shrouded, A, E, PU (2), output (2) Belling-Lee "B"
- 2 Knobs  $\frac{1}{2}$  in. bore Bulgin K14

# Listeners' Guide for the Week

## Outstanding Broadcasts at Home and Abroad

IT is not often that a B.B.C. variety producer can hear as an ordinary listener the broadcast of one of his own shows; this will, however, be the experience of John Sharman on Saturday. He will be on board the *Durham Castle* on his way for a holiday in Teneriffe, and is looking forward to hearing Saturday night's Music Hall programme which he will have rehearsed prior to his departure. I wonder what his reaction will be.

The bill which he has prepared includes Raymond Bennett, Hughie Greene, Morton Downey (world-famous American singer), the Two Leslies and the Duncan sisters. As usual, Music Hall will be heard Nationally at 8.

### MASSED BANDS

FROM the Quarry, Shrewsbury, where the Shrewsbury Musical and Floral Fête will be in progress, will be relayed in the National programme on Thursday at 8.45 a concert by H.M. Irish and Welsh Guards and the Royal Air Force. The flower show is one of the largest and most famous in the country, and is the only one in the Provinces at which concerts are given by massed Guards bands of 120 players. The programme which will be heard on Thursday includes "Vivat! George the King," by Peter Rex, the Finale of Tchaikovsky's Fourth Symphony, and "Finlandia," by Sibelius.

### ENGLISH INNS

A SURVEY of the English inn from early times up to the present day will be presented, in a series of brief episodes entitled "The George and Dragon," by Thomas Burke, for Regional listeners on Monday at 9.35. Beginning with Plantaganet times, listeners will be carried through the various phases of the life of a typical old inn. Each episode is cast in the form of a miniature one-act play and will provide a vivid cross section of English manners and customs. Most of the episodes

will introduce the music and songs which were as much a part of the average inn's hospitality as was its beverage, food and beds. Thomas Burke is the well-known novelist whose volume on "The English Inn" will be remembered by many.

### PROMENADE CONCERTS

LISTENERS will this week have about nine hours of relays from the Queen's Hall. It is with the idea of giving listeners a representative selection from

concert will be heard during the relay from 8 till 9.30 (Reg.). The programme opens with the Overture "Rienzi," followed by Jo Vincent singing Elizabeth's Prayer and Elizabeth's Greeting from "Tannhäuser"; she will also be heard as Elsa singing the love duet from Act 3 of "Lohengrin," with Parry Jones in the title rôle. "Forest Murmurs," from "Siegfried," and "The Ride of the Valkyries" ("Die Walküre") are also included in this evening's relay.

Tuesday brings another hour and a half's relay from 8 (Nat.). Mendelssohn's Overture to "A Midsummer Night's

### RADIO BURLESQUE

NATIONAL listeners on Monday at 8 and Regional listeners on Tuesday at 9 will hear the revival of the radio burlesque by the Melliush Brothers "All at Sea, or the true story of the *Betty Martin*." The Captain of the *Betty Martin* is in love with Susan, and his suit is complicated by Susan's mother, who also comes on board. There are many amusing episodes, a neatly contrived mystery and some first-rate humorous songs in this clever burlesque which had its first broadcast on Christmas Day, 1934. The production will be by Martyn C. Webster, and Reginald Burston will conduct the B.B.C. Male Voice Chorus and Revue Orchestra.

### THE SALZBURG FESTIVAL

IN the home programmes we are to have one relay this week from the Salzburg festival. This will be on Saturday morning at 11.5, when Verdi's "Requiem" will be relayed until 12.45. For twenty minutes preceding the relay, Francis Toye will give an introductory talk.

Abroad many stations will be relaying various items from Salzburg throughout the week. On Sunday at 9, Vienna relays a programme, "Salzburg Honours its Soloists," from the State Rooms of the Residence. Radio Paris and its regional group is relaying Mozart's "Magic Flute," which will be conducted by Toscanini on Monday at 7.5.

### OPERA

NOT every opera is suitable for broadcasting, but one of the few which have proved themselves invaluable for studio production is Bizet's "The Pearl Fishers," which will be heard from Stuttgart at 9.15 to-night (Friday). The story of this opera, by the way, was used by the film producer Robert Flaherty for his beautiful South Sea picture, "Tabu." Stuttgart's studio production should be worth listening to.

The Rome broadcast on Saturday from the Castello di San Giusto, Trieste, is a pleasing bill—"Cavalleria Rusticana," most universally popu-



CONTINENTAL MUSIC will again pervade our homes from the mythical Café Colette on Tuesday at 8 (Reg.). Walford Hyden is here seen conducting the Café Colette Orchestra, the members of which, he wishes to stress, are British.

the concerts, with due consideration for the general programme lay-out and for the musical palate of listeners, that the Controller of Programmes has included larger portions of some concerts than of others.

To-night (Friday), from 8 until 9.35 (Nat.), we shall hear the first part of the first Beethoven concert. The programme includes "Leonora No. 3," the Eighth Symphony and the Fourth Pianoforte Concerto, with Solomon as soloist.

Saturday, popular night, will bring to listeners at 8.30 (Reg.) Poushnoff playing Rachmaninov's Pianoforte Concerto No. 2, followed by Roy Henderson singing Stanford's Three Sea Songs.

Most of Monday's Wagner

"Dream" will open the programme, which also includes Antonio Brosa as soloist in Francesco Malipiero's violin concerto, of which this will be the first concert performance in England.

The combined Brahms-Dvorák concert of Wednesday will be relayed in two sections. From 8.50-9.35 (Nat.) will be heard Brahms' Second Symphony; then, following the interval, Regional listeners from 9.50 onwards will hear two Dvorák compositions—Symphonic Variations and Slavonic Rhapsody No. 3.

Solomon, for the second time this week, will be soloist at Thursday's Haydn-Mozart concert, when he will play the latter's Twenty-Fourth Pianoforte Concerto.

**Listeners' Guide for the Week**—lar of short operas, and "Il combattimento di Tancredi e Clorinda," the ancient classic secular cantata of Monteverdi, first produced in 1624.

The big German broadcast of the week is Richard Strauss' "Rosenkavalier" from the National Theatre, which Munich relays at 7.5 on Sunday. This work, first pro-

duced in Dresden in 1911, was then ultra-modern, though picturing eighteenth century Vienna.

#### BERLIN'S BIRTHDAY

THE Berlin and Deutschlandsender stations will devote considerable time this week to relays and special programmes in celebration of

Berlin's seven hundredth birthday, which is being commemorated throughout the week from August 15th to 22nd.

From 8.10 on Sunday Deutschlandsender broadcasts a programme, "Picture Book of Berlin," which will give listeners a picture of modern Berlin in music and song.

THE AUDITOR.

# Broadcast Brevities

## The New North-East Transmitter

THE Stagshaw transmitting station, which is to replace the smaller one at Newcastle, is nearly finished and will be working towards the end of October. The Duchess of Northumberland will perform the opening ceremony.

The purpose of the new station, which is situated five miles north-east of Hexham and sixteen miles west of Newcastle-on-Tyne, is to improve listening conditions in Northumberland, Durham, Cumberland, Westmorland and North Yorkshire.

## Newcastle's Wavelength

A composite programme, made up from items taken from the various Regional programmes, with some material from the north-east area, will be radiated from Stagshaw. The London and North Regional programmes will form the backbone of the new station's transmissions, and the station, which will take over the Newcastle wavelength of 267.4 metres, will continue to be part of the North Region for administrative purposes.

## Television's Upkeep

JUST as the staff at Alexandra Palace were going on their three weeks' vacation all hearts palpitated at the statements in certain Sunday newspapers to

the effect that the Postmaster-General would within a few days announce a further grant for the television service, variously put at £500,000 and £150,000, according to the fancy of the prophets.

## The Status Quo

The reason for referring to the matter here is to prevent the possibility that viewers may at some future date recall having seen statements about more money being available for the service, overlooking the fact that they were ill-founded, and feeling surprise that as regards the television programme service there is "no change" in quality.

## False Prophets

When Parliament came to discuss the Post Office Vote later in the week the Postmaster-General did not even mention the subject of extra money for television. Very naughty of him to prove the prophets wrong and to shatter the hopes of the television staff.

## A Bottle of Worthing

THE August Bank Holiday period was enlivened by an incautious and injudicious remark (overheard by listeners), following a short talk by Sir Kingsley Wood from a London studio. This got wide publicity. Few listeners, however, seem to have spotted another lapse by a sweltering announcer, to whom sympathy was surely extended by whoever heard him. He was reading an S O S in which Worthing was mentioned. His thoughts, perhaps, were not altogether on the Sussex resort, for he tacked on to the word three letters which are reminiscent of a much-advertised beverage—and then took a furtive sip at the glass of water by his side.

## What They Think

A good deal of curiosity is felt about the attitude of very high officials at Broadcasting House towards these verbal lapses. Generally, where an apology is broadcast, the incident ends there and no disciplinary action is taken. A slip of the tongue, as in the Worthing case, is ignored. In very rare cases only is consideration of the matter by the administrative officers regarded as necessary.

## The Something Hunter

Another little lapse occurred within the past few days which escaped the notice of the critics, anxious though they are to add to the broadcasting gaiety of the nation.

In a programme relayed to the B.B.C. from Knocke a César Franck item was given as "Le Chasseur Maudit," properly interpreted by the B.B.C. as "The Accursed Huntsman." But the Belgian announcer wanted to air his English; "The D . . . d Hunter," he announced sonorously, with which verdict opponents of "cruel" sports perhaps agree.

## Short Wave Entente Cordiale

IN preparation for a full discussion at the Cairo Conference next year of international short-wave broadcasting, Great Britain and America have started collaborating in short-wave tests, the main purpose of which is to determine the effectiveness of directional antennas, transmitting on the same or adjacent frequencies. The signals sent out by the Columbia Broadcasting System and the B.B.C. are directed away from and towards observation posts in Buenos Aires and Brussels, where they are measured and compared. Data which is being collected will also determine the feasibility of two or more stations in different countries carrying out a service simultaneously on several short waves.

## HIGHLIGHTS OF THE WEEK

### FRIDAY, AUGUST 13th.

Nat., 7.30, "Five Hours Back." 8, Beethoven Prom. 10.20, Mary Jarred (contralto) and the Theatre Orchestra.

Reg., 8, Variety from the Palace Theatre, Plymouth. 9.45, "SOS" by "Taffrail."

#### Abroad.

Stuttgart, 9.15, Bizet's opera "The Pearl Fishers."

### SATURDAY, AUGUST 14th.

Nat., 11.5 a.m. Verdi's "Requiem" from Salzburg. 3.30 and 4.30, Commentaries on the International Athletic Meeting. 8, Music Hall. 9, Letters of Queen Victoria written from Balmoral.

Reg., 6 The Buxton Municipal Orchestra. 8.30, Prom. relay. 9.40, Heddie Nash and the Theatre Orchestra.

#### Abroad.

Rome, 9, Operas from the Castello di San Giusto, Trieste.

### SUNDAY, AUGUST 15th.

Nat., 4, Folkestone Municipal Orchestra and Gaby Vallé. 7.20, Troise and his Mandoliers. 10, Violin recital, Antonio Brosa.

Reg., 6.35, Band of H.M. Welsh Guards. 9.5, Fritz Hart conducting the B.B.C. Orchestra. 10, Summer in Wales.

#### Abroad.

Berlin, 8, Weber's "Der Freischütz."

### MONDAY, AUGUST 16th.

Nat., 7.30, Light Music from Stockholm. 8, "All at Sea": a burlesque. 9.5, "Favourites of the famous": Jack Payne and his band.

Reg., 8, Wagner Prom. 9.35, "The George and Dragon": a pastiche of the English inn.

#### Abroad.

Radio Paris, 7.5, From the Salzburg festival, "The Magic Flute" (Mozart).

### TUESDAY, AUGUST 17th.

Nat., 6.25, John Dickinson (Apsley) Band. 7, Light Music from the Kursaal, Interlaken. 8, Prom. relay. 10, "I Saw the Start"—II.

Reg., 8, The Café Colette Orchestra. 9, "All at Sea."

#### Abroad.

Paris PTT, 8.30, Massenet Anniversary Concert.

### WEDNESDAY, AUGUST 18th.

Nat., 5, Henry Hall and his dance orchestra. 8, The Palace of Varieties. 8.50, Prom. Relay.

Reg., 8.50, Flight over Blackpool: a variety programme. 9.50, Prom. relay.

#### Abroad.

Warsaw, 9, Chopin recital.

### THURSDAY, AUGUST 19th.

Nat., 7.30, "The Mill on the Floss": a radio version of George Eliot's play. 8.45, Relay from the Shrewsbury Musical and Floral Fête. 9.15, "Alf 'Awkins in 'Appy 'Armonies" presented by Leon Cortez.

Reg., 6.40, Shows from the Sea-Side—VII. "Twinkle" from the Pier Pavilion, Eastbourne. 8, Haydn-Mozart Prom.

#### Abroad.

Radio Paris, Bordeaux, etc., 8.15, Sir Thomas Beecham conducting Verdi's "Othello," at the Casino, Vichy.



SOLOMON will be heard twice during this week's Promenade Concert relays.



# UNBIASED

## Unprofessional Conduct

I AM, not unnaturally, somewhat pleased with the results which I have been getting with the model of *The Wireless World* television receiver which I have just completed, and have, perhaps, been talking somewhat loudly about it in public places like buses, trains, pubs and barbers' shops. I was, therefore, not altogether surprised when I was stopped in the street by my local medico, who is a very keen television enthusiast.



Unprofessional Conduct.

He expressed great interest in my latest creation, details of which he had unwittingly learned the other day while removing the appendix of a mutual friend, who had persisted in babbling about it throughout the operation. The details of the set were so interesting, said my medical friend, that he dallied over the operation rather longer than he need have done, although actually the patient benefited by it since the doctor found many little odds and ends inside him which required attention, just as you do when overhauling a wireless set, and he filled in the time by tightening things up generally.

The upshot of all this was that the good doctor invited himself round to see the results obtained by my set and in the course of the show I chanced to remark how different television was from the early days of the cinema when the terrible unsteadiness of the picture was apt to cause severe eye-strain. "Now this," I concluded, pointing to the rock-steady television picture, "I feel sure that you will, as a medical man, agree, cannot possibly harm the eyes in the slightest degree." He at once concurred in my opinion, and gave me his professional assurance that my statement was not in the least exaggerated and there the matter dropped.

Some time later I received from him a demand for 10s. 6d. for professional services rendered on the date when he came to see my television set. Somewhat mystified I took the matter up with him, and you can imagine my surprise when I was told that on the date in question, he

By

FREE GRID

had given me professional advice on an ocular matter. Several people whom I have consulted are of the opinion that he is perfectly justified in sending in an account.

There is, I suppose, nothing that I can do about it but pay the wretched account, but I do not intend to let it remain at that and am determined to get my own back, and am already making preparations to this end, and as this will probably mean that my contributions to these columns may be absent for a little while, I am taking this opportunity of acquainting you with what I intend to do.

Knowing full well the propensities of most people for talking shop when under the influence of chloroform—as indeed was evidenced in the case of my friend from whom the doctor got his information about the television set—I intend to call in the medico in the middle of the night with complaints of such excruciating abdominal pains that he will be led to perform an immediate exploratory operation. Knowing his keenness on radio matters as I do, I am quite sure that he will not miss this unique opportunity for increasing his stock of knowledge.

I have already prepared an account "for professional services rendered," which I have instructed Mrs. Free Grid to send to him immediately the operation is concluded, irrespective of what its outcome may be. Even in the unlikely event of its terminating fatally, therefore, I shall at least have the satisfaction of knowing that I have conveyed to him in as delicate a manner as possible, exactly what I think of his outrageous pecuniary demand.

## Unpunctual Servicemen

I HAVE received many interesting letters as a result of my note concerning the great lack of punctuality among servicemen. Many ingenious explanations have been forthcoming, but by far the most likely alternative to my own suggestion is that mixed with the hard-working efficient servicemen of to-day, there is probably still a fair sprinkling of ex-plumbers who graduated as "radio engineers" overnight in the approved fashion of the early days of broadcasting.

## A Mysterious Fault

IN the course of a long and busy life, there are really very few faults to which the radio flesh is err that have

not, at some time or other, come within my purview. One which occurred the other day was, however, very definitely a new one on me, and possibly you may like to hear of it. In any case, whether you like it or not, you are going to hear of it so you may as well do so with as good a grace as possible.

The symptoms which had developed in the set concerning the misdemeanours of which I was called in consultation, were ones that used to be exceedingly commonplace, namely, a gradual falling off in volume and quality. Such manifestations used to be indicative of almost anything from dirty aerial insulators to failing valve emission. Since the coming of AVC, however, the symptoms of these faults have, for the most part, been replaced by increasing background noise. I was, therefore, somewhat surprised at the development of such an old-fashioned thing as failing signal strength, and sat up all one night with a wet towel round my head racking my brains to think of some fault which would cause a falling off of volume of a type which would not instantly be corrected by the action of AVC.

It appeared obvious that the fault was on the LF side of the set, but there appeared to be nothing whatever wrong there. It was only as a last resort that I thought of the loud speaker which was slung from the picture rail on an ornamental baffle. To my astonishment I found that the cone of the loud speaker had almost completely disappeared, its condition being as indicated in the accompanying photograph, which I immediately took with the miniature camera which is my invariable companion. The ornamental fret had, of course, prevented the damage from being obvious.



A loud speaker cone — that was.

I immediately fitted a new diaphragm, but in a very few weeks it went the same way as the old one. Two other new ones have gone in a similar manner, and I am being slowly forced to the conclusion that they must have been devoured by—pardon me, ladies—vermin, and I am sorely troubled as to the best way to tackle the problem. I have been strongly advised to try coating the cone with creosote, but this, I fear, will have an adverse effect on the tone of the loud speaker, and apart from this I am liable to get the R.S.P.C.A. on my track. Can you make any useful suggestions?

# Letters to the Editor

## Propaganda Broadcasts

THE use of broadcasting for propaganda in the international sphere has been a matter of concern to all who are interested in world affairs for a year or more. I suggest the following as the outline of an international convention to be ratified by all Governments, not broadcasting authorities:—

No broadcasting station shall transmit comments on foreign affairs in any language other than those of territories which come under its control.

If this degree of international decency could be attained one might hope at a later date to follow it with more constructive action towards the ideal that "Nation Shall Speak Peace Unto Nation." The next stage might be an international news bulletin prepared weekly by an impartial editorial board, and made available to all broadcasting authorities. Finally, nations could submit short talks explaining their particular difficulties and aspirations, to be included in the weekly bulletin subject to the censorship of the central editorial board. There could be no better approach to international understanding. D. A. BELL.

Chelmsford.

## Hand-capacity Relays

THE article "Magic from the Air," published by you some time ago, recalled to me my own device, which was in operation in the window of a retail shop in Sussex last year for about three weeks on end. Readers may be interested in a few practical details herewith.

On the *inside* of the plate glass front window (at a height of about 6ft. to escape the continuous and unprofitable attentions of small boys!) was pasted a cardboard "hand." A notice invited passers-by to place their own right hand over this cardboard "hand." As soon as they did so, a fairly powerful receiver standing just inside the doorway abruptly blared out music at them. When they removed their hand the music stopped. The sensitivity was such that a hand had to be brought only to within 10in. or 12in. from the window for operation to take place. There was apparently no connection at all; five shillings was offered to the first person who could tell us how it was done, but although the device was in operation for eight hours a day for three weeks, nobody got the money!

The thing was very simple. The card "hand" was composed of two layers with a 2in. square of cigarette foil between them. From this foil a length of 36 s.w.g. enamelled wire ran to the grid of a triode valve oscillator placed, with accumulator and HT eliminator, behind a showcard. The intensity of oscillation was, of course, varied by the capacity between the foil and the hand of the passer-by. This caused variations in anode current from 12 mA. to 5 mA., which was sufficient to operate a home-made relay. Sensitivity adjustments were made on the relay and by means of the HT supply potentiometer. The device needed occasional attention, of course, as it was very roughly constructed. The oscillation frequency was about 5 megacycles—60 metres—and the anode and grid coils were wound on an old 6-pin former.

The relay normally held open the speech coil circuit of the receiver (which was switched continuously on) but closed it when the anode current was varied by the approach of a hand to the window, thus causing the abrupt burst of music. To avoid damage in the output stage, 6 ohms was left permanently across the speaker transformer secondary terminals to provide a load. W. H. CAZALY.

Barking, Essex.

## Transient Response

MY friend, Mr. Voigt, throws out some interesting challenges in his article on Transient Response. They are quite easy to meet, except in so far as he requires everything to be non-mathematical: one cannot easily make a verbal translation of Fourier's Integral Theorem! However, I will do my best within the limitations which he has set.

First, then, as to Mr. Voigt's own pet transient. It looks so sweet and smooth and innocent sitting there in Fig. 4 of his article, yet in truth it packs a punch like the kick of a mule, as I will now demonstrate.

Surely it is stark obvious, even to a non-mathematician, that this transient (or any other transient, if it comes to that) must contain a good deal more than 300 and 600 cycles; because if we mix a 300 cycle note with a 600 cycle note, in any amplitude and phase, we *must* get a *continuous* note, and not something which starts and stops with a jerk.  $y = a \sin(pt + \phi_1) + b \sin(2pt + \phi_2)$  cannot be anything but purely periodic, no matter what values we assign to the constants  $a, b, \phi_1, \phi_2$ . Such an expression can be made to represent a succession of such "transients" running smoothly into each other and repeated indefinitely; but that is merely a roundabout way of describing a steady note, and is a very different thing, both practically and mathematically, from one of the transients all by itself. Incidentally, it is impossible to represent a transient by a Fourier series, it needs a Fourier integral.

So much for what Mr. Voigt's transient is not: now for what it is. It certainly contains frequencies up to infinity, and we may say very roughly that their amplitudes fall off inversely as the frequency, but with a certain waviness superimposed on the falling off. To find the amplitudes you have to work out the Fourier integral, but to demonstrate the existence of high frequen-

The Editor does not hold himself responsible for the opinions of his correspondents

cies to the non-mathematician it suffices to point out that the transient not only contains the very "special transient selected by the mathematicians" (a sudden step up or down) which Mr. Voigt derides, but contains it four times over! I admit it is cunningly concealed, but it is there nevertheless. The sudden jumps occur, not in the amplitude, nor in the velocity, but in the acceleration, and they occur at the points where the two component curves in Fig 4 meet the axis. Since force and acceleration are proportional, it would be necessary for the applied forces to jump from zero to a finite value in zero time in order that a mass should execute even the first quarter of this apparently so innocent transient. That is how the infinite frequencies come in.

Now for the connection between transient response and steady-state frequency response. Fourier's Integral Theorem expresses a transient as a band of steady waves of different frequencies, amplitudes, and phases. It is the omission of the phase characteristic by the non-mathematicians which leads to all the confusion. Mr. Voigt's hypothetical loud speaker and echo chamber may or may not have a level response curve, but it is obvious that its phase-frequency curves will be like nothing else on earth, and for that reason it will not reproduce transients properly.

Let there be no mistake; there is no question of the "truth in practice" of the Fourier integral representation of a pulse function by a frequency spectrum. The two represent the same thing, but are written in different language, in precisely the same way that  $2-2$  is the same thing as  $0$ . If, therefore, a loud speaker reproduces all frequencies with the same amplitude and phase shift, then it *must* reproduce transients properly, for the simple reason that "a transient" is merely another name for a spectrum of frequencies with certain amplitude and phase relations between them.

It follows as a corollary that two graphs are required completely to specify the performance of a loud speaker: the ordinary amplitude-frequency graph, and the phase-frequency graph, and that (apart from non-linear effects at large amplitudes) the response is, in fact, thereby completely determined, both as regards the steady-state and transient responses of the instrument.

The resonance effects, with the persistence of damped oscillations after the removal of the exciting forces, are, of course, taken completely into account by

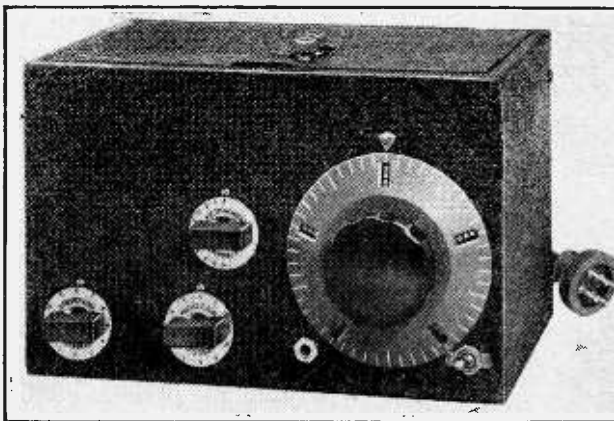

ONE TO ELEVEN METRES is the waverange covered by this American receiver, recently introduced by the National Company, Inc., of Malden, Mass. Four valves, two of which are "Acorns," are used in a self-quenching super-regenerative circuit with a preliminary stage of tuned RF amplification. The power supply, derived either from batteries or mains, is obtained through a separate unit. Wave-changing is effected by plugging in the appropriate pair of coils; the complete range is covered by six pairs. Provision is made for using the set with either an earthed or unearthed aerial.

the Fourier treatment, because the resonance point is the seat of violent phase and amplitude fluctuations which will show up in the two graphs.

To sum up: Transient response as distinct from frequency response is a myth, but you *must* state phase as well as amplitude when you specify frequency response, otherwise you are not telling the whole story.

Brighton. W. BAGGALLY, M.I.W.T.

**M**AY I be allowed to make a few remarks on Mr. Voigt's article "Transient Response"?

Let us first take the case of the transient shown in Fig. 1. Heaviside called this the unit function and wrote it as  $[1]$ . This function has a value of zero for all values of  $t < 0$ , and of  $+1$  for all values of  $t > 0$ . As Mr. Voigt admits, this can be analysed into an infinite series of sine curves of all frequencies from zero to infinity.

Using this function, we can write down any transient in a mathematical form.

Let us take the curves shown in Fig. 4. Taking the commencement of the curve, it can be described as a cosine curve, together with a finite displacement, which starts at some given time. This we can express by multiplying together the unit function and the cosine term + the displacement, i.e.,

$$[1] \times (-1 + \cos \omega t). \quad (i).$$

After a time  $t = 2\pi/\omega$ , the function is again zero. This can be brought about by applying, at that time, a similar expression to that above, multiplied by  $-1$  so as to cancel the wave expressed in (i).

Let us now expand (i). The expansion is  $-[1] + [1] \cos \omega t$ . The first term involves all frequencies from zero to infinity, since it is the unit function with a minus sign prefixed. The second term involves the product of a cosine term (i.e.,  $\cos \omega t$ ), with a term consisting of sines of all angular velocities from zero to infinity (i.e.,  $[1]$ ). The product will obviously involve all frequencies from zero to infinity. A similar argument will hold for curve B.

Thus the frequency spectrum of the transient will extend from zero to infinity, with peaks at 300 and at 600 cycles per second. Consequently, a frequency range of zero to infinity is necessary for perfect reproduction of this transient.

Using a similar argument, I think it is possible to show that the same conclusion will be reached for all transients.

Perhaps someone more versed in acoustics will deal with the case of the imaginary speaker, but my opinion is that his imaginary speaker is impossible, since the fact that there is a delay in the building up of the applied wave means that the frequency response cannot be level. Hence, a speaker in which the moving parts are heavy (i.e., all speakers) will not have a flat frequency response, and consequently will not be able to reproduce transients faithfully.

London, S.E.23. F. SCOWEN.

**H**AVING read Mr. Voigt's article on Transient Response, and being interested in this subject, I should like to offer an opinion on this problem.

First, I think everybody will agree with Mr. Voigt that the theorist's idea of a transient could hardly occur, for then we should have something occurring in two places at the same time.

Now the connection between frequency response and transient response can be shown by drawing a series of sine (or cosine)

curves of different frequency on the same time base. This will make it clear that what is of first importance is the steepness or slope of the rising front of the transient compared with the steepness portion of the sine curve. In practice this means that if a speaker cuts off at 5,000 c/s, then it cannot reproduce a transient having a rising front with the steepness of, say, a 10,000 c/s note.

There are, however, two additional factors to contend with in practice. First, the back EMF, i.e., opposing voltage due to moving speech coil, and, second, mechanical weight. These cause delay at the start, giving a slight bend to the correct line. High flux and low inductance with, of course, lightness of moving parts show the direction in which improvement is to be expected.

GUS. DAVIES.

London, N.W.10.

### Broadcasting to Schools

**I**N the letter of your correspondent E. F. Good, of Sheffield, in the June 25th issue, a Committee to listen to the above was mentioned. A representative of some such body inspected a 1932 DC model of an American superhet. table model with an 18 output tube, a bowed  $\frac{1}{2}$  in. plywood cabinet and a speaker of about 4 in. diameter.

This set, bought by the boys' subscriptions, gave him satisfaction, and, as a result, the school will not receive another set such as are now to be provided by the authorities.

Had the significance of the visit been realised, it would have been simple to have temporarily disabled it, or even totally, as it was painful to hear, sometimes difficult to follow even to a hardened short-wave listener on the staff.

Your correspondent is right. Something else is definitely needed.

G. A. B.

Birmingham.

### Tone Correction and Waveform

**H**AVING waited in vain for the No. 8 Hats to comment on Mr. J. H. Reyner's article on "Amplifier Correction and Waveform" in the June 25th issue, may I, as a quality enthusiast with little technical knowledge but some 20 years' experience of practical receiver construction, make a few remarks?

Since no one has contradicted Mr. Reyner's statements, I presume that they are accepted as facts. In that case, can any of your readers explain why the Hartley Turner MA receiver (which was reviewed in the same issue) is free from audible harmonic distortion? I can vouch for this, having had the pleasure of listening to one recently. The instrument being reproduced was one with which I am very familiar, viz., the organ of the Union Cinema, Kingston, played by Harold Ramsey. Also, being the owner of one of Messrs. Hartley Turner's speakers, I can corroborate their statement that their speaker shows up any harmonic distortion present.

Perhaps P. K. Turner could be persuaded to give his views on the subject. May I also endorse the remarks of your correspondent D. H. Smith in a recent issue. My present is my first (and last) mass-produced set. Although it cost £20 it is inferior in quality to many previous home-constructed outfits, mostly of *Wireless World* design.

A. D. JONES.

Chertsey, Surrey.



# MCCARTHY

## SPECIAL 9-VALVE FOUR-WAVE SUPERHET DE LUXE

The De Luxe Model of this exceptional receiver includes many interesting features, and combines unusual sensitivity with great flexibility of control. Only receivers now on the market at very much higher prices can claim so high a standard of design and performance.

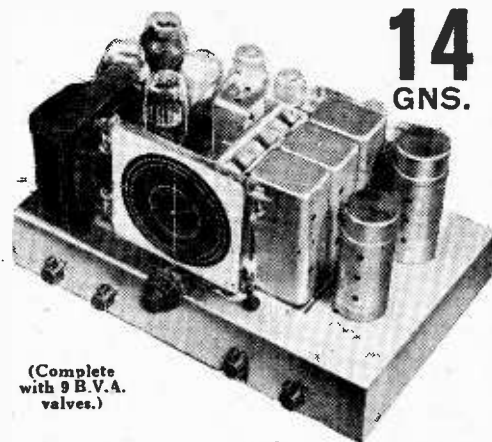

**14  
GNS.**

(Complete with 9 B.V.A. valves.)

4 wavebands: 12.8-33, 29-80, 190-550, 800-2000 metres. Illuminated dial with principal station names.

**Controls.**—A feature of the receiver is the number of independent controls fitted, making it extremely interesting to operate. These include: sensitivity control (varying bias on R/F stage). Q.A.V.C. with manual muting control for inter-station noise suppression. 5-position wave-change and gramophone switch. Progressive variable tone control operative on radio and gram.

**Circuit in Brief.**—Aerial input to pre-selector circuit, radio frequency amplifier, latest type triode-hexode frequency changer. 2 band-pass I.F.T. coupled I.F. amplifiers, double diode detector. L.F. amplifier and special push-pull pentode output stage. Heavy cadmium plated steel chassis. Finest components and workmanship throughout.

Harries' tetrodes can be fitted in place of pentodes in output stage if desired.

A.C. models ready for immediate delivery. A.C./D.C. models also in production, and will be available for delivery shortly.

STANDARD MODEL 12 GNS.

as above, but with triode push-pull output, and fewer controls fitted.

### IMPORTANT

The prices at which McCarthy Chassis are advertised include Marconi Royalties. "Wireless World" readers should, for their own protection, make sure before purchasing any receiver that the quoted price includes the Royalty payment.

All McCarthy receivers supplied complete with valves, knobs, pilot lamps, leads, mains cable and plug. 12 months' guarantee. (Valves 3 months.)

Deferred terms on application, or through London Radio Supply Co., 11, Oat Lane, E.C.2.

Cash with order on 7 days' approval. Also write for illustrated catalogue of complete range of all McCarthy receivers.

**MCCARTHY RADIO LTD.**  
44a, Westbourne Grove, London, W.2

Telephone: Bayswater 3201/2.

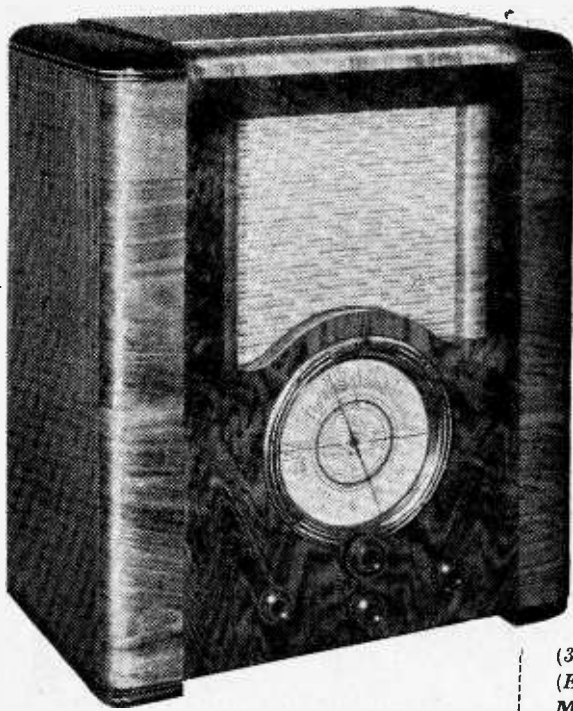

# Pilot MODEL B344

A BATTERY SUPERHETERODYNE  
OF HIGH EFFICIENCY

**FEATURES.** *Type.*—Table model superheterodyne for battery operation. *Waveranges.*—(1) 16-52 metres. (2) 168-555 metres. (3) 740-2,200 metres. *Circuit.*—Heptode frequency-changer—var.mu screened grid IF amplifier—double-diode-triode second detector—QPP output stage. *Controls.*—(1) Tuning. (2) Volume and on-off switch. (3) Waverange. (4) Tone. *Price.*—(Excluding batteries) 11½ guineas. *Makers.*—Pilot Radio Ltd., Park Royal Road, Acton, N.W.10.

THE designers of Pilot receivers have always shown a flair for extracting a high efficiency in relation to the number of valves used in the circuit. This applies particularly to the short-wave range, and in this respect the receiver under review is no exception. In the interest, no doubt, of battery economy an RF stage is not included, but even so not the least difficulty was experienced in obtaining reliable reception of American broadcasting as well as of all the principal Continental short-wave stations.

In the particular receiver tested the 16-metre band was, if anything, more sensitive than the 20-metre, and although Schenectady was satisfactory, Bound Brook was the station to which one would turn when showing off the paces of the receiver. In view of the high over-all magnification on short waves it was not surprising to find a trace of microphonic feed-back with the volume control at

maximum, but as this setting more often than not overloads the output stage, it is only occasionally that one feels that the range of the set is limited from this cause. The high intermediate frequency (456 kc/s) ensures that second-channel repeat points on the short-wave band are well separated and are of only a fraction of the signal strength at the main tuning point.

On the medium- and long-wave ranges the low background noise, which is one of the advantages of battery reception, seems to enhance an already high sensitivity and there is nothing which a mains-operated set of similar specification will do that cannot be repeated, or even improved upon, by this receiver. Excellent volume was obtained from the Deutschlandsender with a trace of background from Droitwich and Radio-Paris. On the medium waveband between 1½ and 2 channels were lost on either side of Lon-

don Regional when using the set with a full-sized aerial in Central London.

A double pentode QPP output valve, in conjunction with an efficient permanent magnet moving coil loud speaker, gives really excellent volume with plenty of attack and a good bass response when the station is accurately tuned. There is one aspect of the performance from the quality point of view with which we are particularly impressed, namely, the definite manner in which the reproduction changes from perfectly clear harmonic-free quality to obvious overload distortion when the limits of the input to the last stage are exceeded. Too often this transition is extended over a wide range, so that a difficult decision regarding the compromise between volume and quality has to be made by the listener when approaching the upper limit of the set. In the Model B344, however, the quality is maintained right up to the last minute, so to speak, and, what is equally important, there is no trace of the distortion at low volume levels which is sometimes experienced with QPP output stages.

### Current Consumption

It is true that the HT consumption is rather more than that of, say, the average battery portable, but it is nevertheless within the capacity of the modern standard size HT battery, and the efficient circuit ensures that every single milliamp. is well employed. The output valve is rated for a maximum HT voltage of 135 and the measured average current consumption for the set as a whole, working on a powerful local station, was 12 mA.

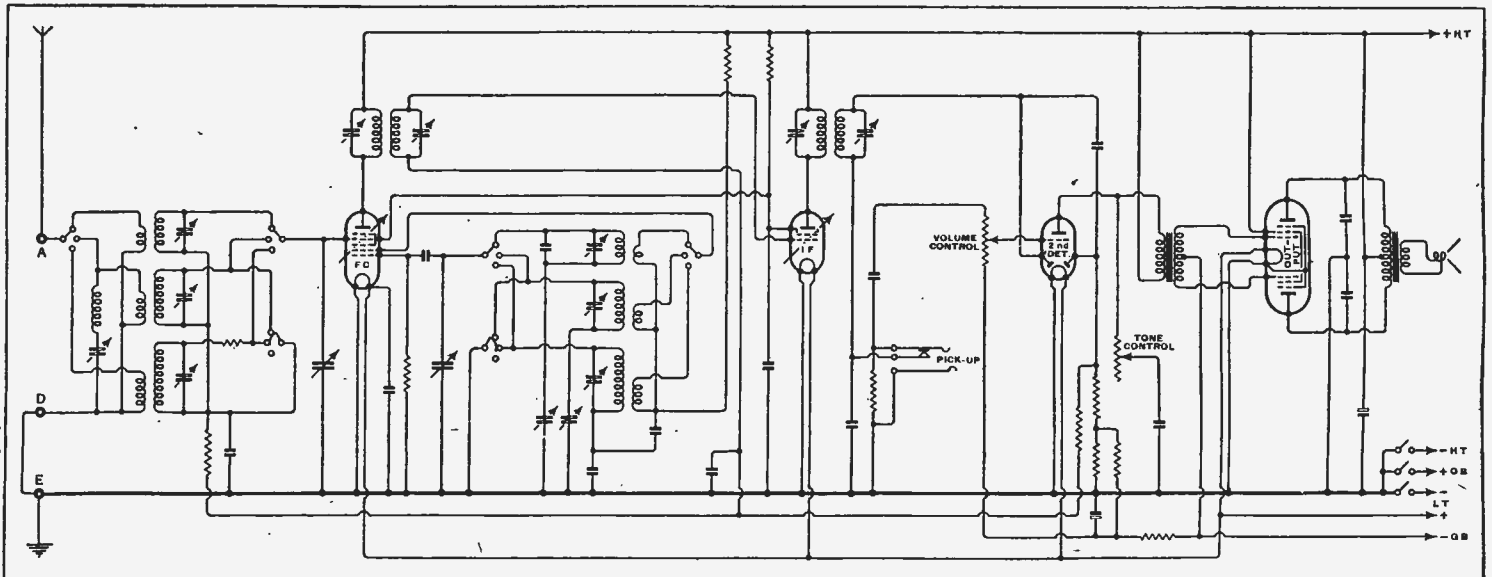

The aerial circuit is arranged for a single wire or doublet aerial. Note that all three batteries are disconnected by the on-off switch.



**Pilot Model B344—**

This figure was obtained with a bias of  $-10\frac{1}{2}$  volts, but slightly more volume was obtained by reducing the bias to  $-9$  when the average current was approximately 14 mA. In the absence of a carrier wave when the anode current of the early stages in the set rises under the action of AVC, the steady anode current was 16 mA. The set, however, gave excellent results with lower values of HT and at 90 v. with  $-4\frac{1}{2}$  v. bias the standing current, in the absence of a carrier, was 12 mA. and the average current on the local station, when modulated, about 10 mA. It is safe to say that with 90 v.

the makers on the service information which is included with each set. When supplied with this information any local serviceman should be able to check over the circuit alignment if any trouble is experienced with the set while on tour.

**Handbook for Wireless Telegraph Operators working Installations Licensed by H.M. Postmaster-General.** Pp. 104. H.M. Stationery Office, Kingsway, London, W.C. Price 9d.; postage extra.

REFLECTING the increasing scope and complexity of radio communication, the new edition of this publication appears as a considerably bulkier volume than that

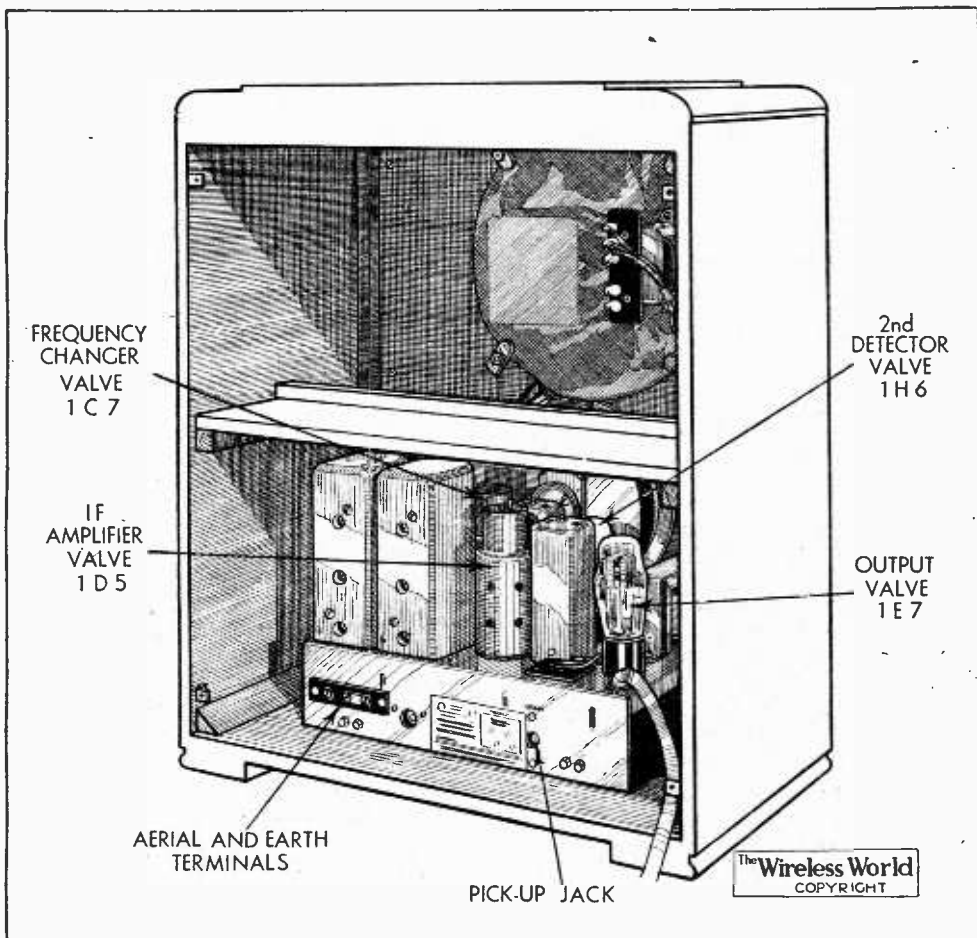

All trimmers are readily accessible from the back of the cabinet, and service men's instructions for alignment are included with each receiver.

HT the set gives normal battery receiver performance and that with a 120 or 135 v. HT it would be possible to deceive a newcomer into thinking that the receiver was working from mains.

The set has been produced to meet the demands of those who wish to take a receiver with a first-class performance, including short waves, on holiday expeditions, and it is put forward as being suitable for use on sea-going vessels. There is nothing in the cabinet-work, however, to suggest that it is designed for rough handling, and the walnut veneer finish is quite up to the standard required for a permanent domestic receiver.

A jack is provided at the rear of the chassis for connecting a gramophone pick-up, for which the volume control in the receiver is effective.

In conclusion, we would congratulate

with which many of our older readers are familiar. The official scope of the Handbook is made clear by its title, but to the keen amateur and even to the wirelessly minded general reader there is much of interest in its pages; the book is, of course, essential for amateur transmitters, and it also adds much to the interest of listening to morse code transmissions, as the official procedure in calling and handling messages of all kinds is described at length.

Almost all aspects of a wireless operator's work (other than the purely technical) is dealt with in its pages, and besides there is much general information that is certainly not common knowledge. For instance, "licences for the use of (broadcast) wireless receiving apparatus on board ships are issued only in the name of the shipowners and not to passengers or members of the crew individually. One licence will suffice for each ship." These ship licences can be obtained from the G.P.O.

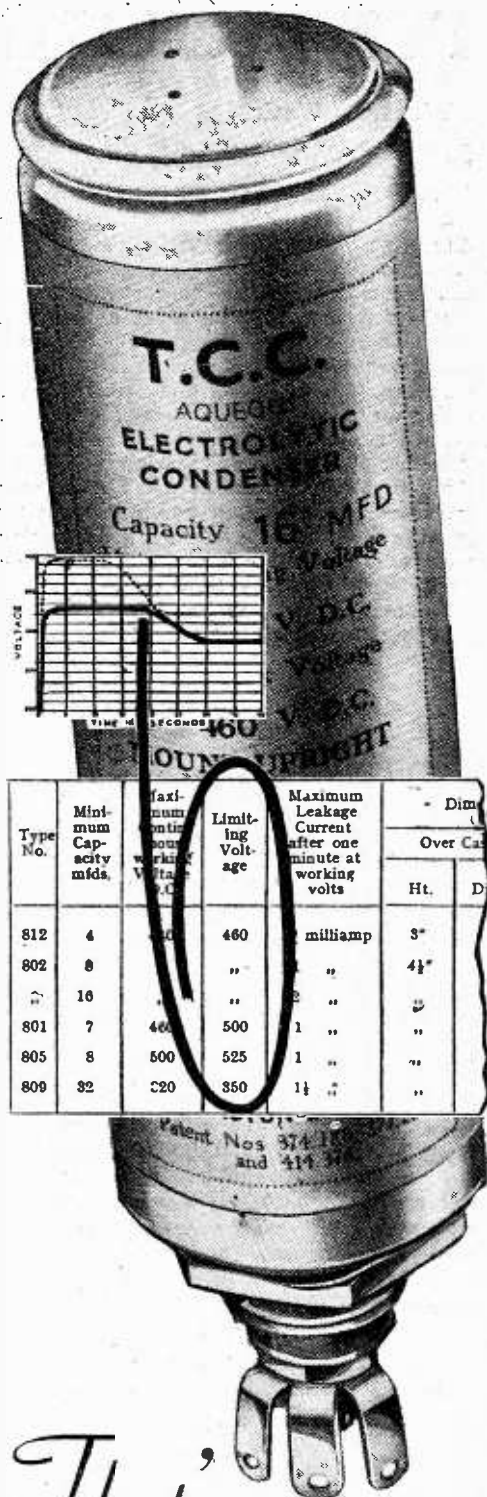

Type No.	Minimum Capacity mfd.	Maximum Working Voltage V.D.C.	Limiting Voltage	Maximum Leakage Current after one minute at working volts	Dimensions	
					Ht.	Dia.
812	4	400	460	milliamp	3"	
802	8	400	"	"	4 1/2"	
801	16	400	"	"	"	
801	7	400	500	1 "	"	
805	8	500	525	1 "	"	
809	32	220	350	1 1/2 "	"	

That's HOW  
**T.C.C.**  
**SURGE-PROOF**  
**WET ELECTROLYTICS**  
 safeguard A.C. Receivers against damage from 'NO-LOAD' Voltage Surges.  
*(w.ite for full details)*  
 THE TELEGRAPH CONDENSER CO. LTD.,  
 WALES FARM ROAD, N. ACTON, W.3.  
 2426.

# Random Radiations

By  
"DIALLIST"

## Wednesday Week

ONLY twelve days now until the turnstiles are clicking once more at Radiolympia. Advance publicity has told us lots and lots about the stars which will appear in the theatre and about the special television programmes that are being arranged. But I can assure readers that there will also be some wireless sets, quite a lot of them in fact. To be serious, it ought to be an exhibition well worth visiting, for it will let us see some of those bigger and better sets for which we have been clamouring for so long. I have had the opportunity of seeing and handling one or two of them already and I think that they will make a big impression on more discriminating purchasers, partly because of the quality of their reproduction and partly because their performance is such an eye-opener, particularly on their short-wave ranges. If you have been used to handling the small set which has to be worked pretty well all out to get any but the most strongly received short-wave stations, it's a revelation to use a big set which seems nearly always to be working well within itself.

## Explosion!

JUST before the holidays I received a new wireless set of the battery order which I urgently wanted to try out before going away. I unpacked it, finding something that looked delightful, with a cabinet of original design and an inside which was obviously well made. I was rather sorry to find no fewer than seven battery leads; however, the instruction book would no doubt show at once how they should be connected. But there wasn't any instruction book, though I looked high and low for it. All the shops were closed, and even if they hadn't been there are none in my locality that deal in this particular set. "Never mind," thought I, "it's dogged as does it, and with my trusty voltmeter I can soon find out what those leads mean." Two were obviously for the LTB owing to their spade tags. Two others, bearing red and black plugs, identified themselves as HT+ maximum and common HT- and GB+. The other three took a bit of tracking down, for some of the valves were in rather inaccessible spots. Not without dust and heat I completed my task and connected up. The set wouldn't work! A further series of tests disclosed the presence

of a dud valve of a complicated type—just about the one battery valve for which I had no replacement. Can you wonder that your "Diallist" went right up into the air and felt like letting off steam with the aid of a coke hammer?

## Interference Liquidation

THEY keep their wireless up to the mark in Russia! The other day I read that the director of some totally unpronounceable station or other had been arrested (and would doubtless be liquidated in due course) on a charge of deliberately causing interference with propaganda broadcasts. It is alleged that though musical programmes were received to perfection by listeners, every political speech was submerged beneath a roar of what sounded like atmospherics. Frankly, my sympathies are all with the accused. Would that all propaganda broadcasts for every country might be treated in the same highly satisfactory way. But liquidation of offenders seems to have possibilities as a means to ending man-made interference if only we were courageous enough to apply it in this country. I can suggest right away several deserving candidates in my part of the world.

## A Loss to Wireless

IT was with real sorrow that I read of the death of Mr. W. R. Bullimore, who was for so many years the head of the firm of Cossor. He was one of those pioneers in valve manufacture who did so much to found wireless firmly as a national hobby and help forward its progress during the fifteen years that we have had a regular broadcasting service in this country. Old readers will remember the famous Cossor "tin-hat" valve, with its striking originality of design and its excellent performance for a valve of those days. This, and the novel form of filament suspension that it incorporated, were actually the designs of Mr. Bullimore. Not so very long ago, when I was at the Cossor works, I was told that there was still a small demand for the "tin-hat" valve! There must be some pretty ancient sets still in use, for I see in recent Marconi and Osram lists that the original "R" valve is obtainable, although its price has now been raised from 5s. to 25s., thus bringing it back to about where it was in the early 1920's.

## Why Not a Replacement Set?

ONE thing that has surprised me for some time about our radio manufacturers is that so few of them seem to endeavour to design receiving sets for the replacement market. And yet in this country the market for receivers is becoming naturally more and more of that nature. If wireless users renew their sets every four years on the average, replacements account for annual sales of something over two millions, though newcomers to wireless don't now number much over half a million a year. The actual figure for the licence increase between the end of June, 1936, and the same date this year was 533,573. Renewals should, of course, take place more frequently than once in four years—the 1933 and even the 1934 models are pretty much back numbers nowadays. But you can't induce a man to change oftener unless you offer him a set that is in all sorts of ways better than that which he now has. I may be wrong, but my impression is that for the past two years or so the prospective customer has been offered very much the same set at a lower price.

## A Suggestion

Though I can't claim to be versed in the mysteries of commerce and finance, I have always understood that big price reductions paid only on a rapidly rising market. Once your market is more or less stabilised the sound course is to give the purchaser something a great deal better than last year's model at much the same price. Not so very long ago we regarded £12 to £15 as the normal price for a set covering the long-wave and the medium-wave bands only. A large section of the public showed that it was perfectly willing to pay that price, with £3 or £4 extra, for an "all-wave" model. Cheaper sets there must be because many people have short purses; but the offer of replacement sets at prices of about the old level would, I think, have been a great success, and still might be.

## What is a Replacement Set?

What exactly do I mean by a replacement set? Just this: Were I a set manufacturer I should, I think, keep a very special record of the shortcomings, big and small, of my current models as disclosed by outside criticisms and by correspondence with purchasers. My endeavour the following year would be

## OLYMPIA RADIO SHOW—AUGUST 25th TO SEPTEMBER 4th.

### THREE SPECIAL NUMBERS

*The Wireless World* will again devote additional space to giving readers a fully illustrated account of everything of interest at the Exhibition.

**AUG. 20th.**

**GUIDE TO THE SHOW.** A forecast indicating, from what advance information is available, many of the new features that will be seen at Olympia.

**AUG. 27th.**

**COMPLETE SHOW REPORT.** A stand-to-stand review which will serve as a useful guide to the Exhibits to be found in this year's Show.

**SEPT. 3rd.**

**OLYMPIA REVIEW.** Fully illustrated reports by *The Wireless World* technical staff on new developments and general trend of progress revealed by a careful survey of all that was to be seen at the Exhibition.

to give them something from which as many as possible of these defects had been removed and in which I had spent the savings effected by more modern production methods on real improvements. Last year's set might have been inclined to whistles and to background noises; this year, if I didn't reduce the price I might be able to get rid of these reproaches by adding a signal-frequency valve. If there had been in the past breakdowns through the use of components with a factor of safety that was hardly sufficient, I could afford to make my set reliable by the use of better components.

And so I think I should be able to say to my customers: "It's well worth your while to change your set, for though the old one was pretty good, this year's is a real advance upon it." Don't you think there's something in this suggestion?

### Time to Wake Up

MORE than once in these notes I have mentioned that we were in danger of finding the valuable Indian market for wireless sets snatched from our grasp before we have made any real effort to develop it. An article in a recent issue of the "Wireless Trader" shows that my predictions have so far been borne out. Though wireless sales in India are large and growing rapidly with the development of the Indian broadcasting system, the Americans, and to some extent the Dutch, have simply left us standing still. All this seems rather tragic, for, though India as a whole is a poor country, there are thousands and thousands of people there who can and do pay from £20 to £40 for good-class wireless receivers. Recently some of our firms have turned their attention to developing sets for the Indian market, and one does hope that a real effort will be made to make up the ground that we have lost before it is too late to do so. Most British folk living in that country would prefer to buy sets of our manufacture; but what are they to do if nothing suitable is on offer?

### Dark Deeds

IT'S curious to notice what defects in their receivers set manufacturers can occasionally allow to slip in without noticing them. Some time ago the laboratory model of a set made in the provinces came down to me for trial, accompanied by a very glowing letter from its designer. He was at first incredulous and then horrified when I told him that at my place, which is about fifteen miles from Brookmans Park as the wave waggles, both the London National and the London Regional stations produced strong "images." Luckily I was in time to point out the defect before the set went into production. A still queerer case occurred quite recently when a set of another make went on to the test bench. Though not outstanding for sensitiveness or selectivity, it didn't seem too bad on the whole during its first trials. Then something prompted me to go carefully over the long-wave band after dark. To my no small surprise I found both the London National and the London Regional programmes breaking through so strongly that they came in at full blast with the manual volume control turned a long way back from maximum. Thinking that the set might be out of alignment I asked for another, which behaved in exactly the same way. There was no daylight break-through, curiously enough. I can only imagine that the designer was satisfied with the daylight results on the long waves and had never tried the set on that band after dark.

### Worth Noting

IN the old days of wireless we used to say—I have written it myself many a time—that if you wanted to see what a set could do you should try it in the daytime. That's a very long way out of date nowadays. You will certainly get a pretty good idea of the sensitiveness of a receiver if you test it on the medium-wave band in daylight; but today there are other things to consider. You don't want second-channel squeals and you don't want break-through in the evening, which is the time when most of your listening is done. A set may be perfectly free from either of these faults in the daylight though they may be strongly in evidence after dark. When, therefore, you are buying a set it is no bad thing to have it demonstrated after car lighting-up time. You will then be able to spot any of these shortcomings without much trouble. In a good many sets the long-wave range is apt to be the weak point. To a thousand listeners this doesn't matter the proverbial two hoots, since the long waves are such a mess nowadays. But there are other thousands who can't receive the local National—their number has been vastly increased since the B.B.C. decided to close down the London and North Nationals until 5 p.m.—and have to rely upon Droitwich for reception of the National programme. To them it is of great importance that a set should not fall down on its long-wave range, and since the B.B.C.'s declared policy is to make Droitwich eventually the sole provider of the National programmes good performance on the long waves is likely to become more and more desirable at time goes on.

### Brighter Broadcasting

MY earnest hope is that those delightful technical slips of the B.B.C. which have done so much this summer to light up the darker patches of broadcasting will not be too sternly repressed by authority. I am not suggesting that Sir Kingsley Wood's recent talk was one of these darker patches; it wasn't, though the rest of the programme that evening hadn't been too enlivening. When that historic interjection that followed it was broadcast to the world it must have caused one of the heartiest laughs for which the B.B.C. has ever been responsible, or, should one write irresponsible? It is just these little human touches, these welcome technical slips, that make us realise for a moment now and then that Broadcasting House is no mere machine; men are men in its great open spaces.

### A Tuning Dial Grouse

WHY, I wonder, do some manufacturers set the tuning dials of their receivers rather far back and surround them by a deeply bevelled escutcheon? It's an awful nuisance because if any part of the scales is near the rim of the dial you can't read it unless you bring your head down until your eyes are about on a level with the tuning knob. If the set is a console this may mean having to kneel down to do your tuning, and you have to stoop to be able to see what you are doing with a table model. It may seem a small point but it is just these little things that make all the difference to the ease of handling a wireless set and to one's pleasure when doing so. If the dial has to be a good way from the front of the cabinet the bevel should be a very gradual one, so that it does not obscure any part of the scale when the operator and the receiver are in their normal positions.

## NOTABLE FEATURES of the *New* ROLA F 742-PM

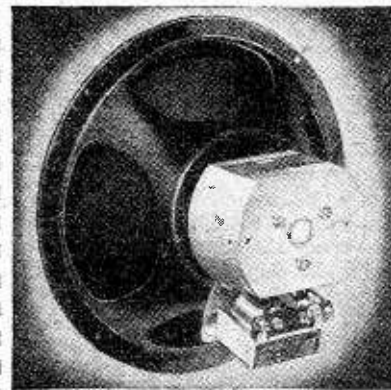

### A HIGH SENSITIVITY SPEAKER OF REALLY CONVENIENT SIZE

When operating conditions require extreme sensitivity without demanding the exceptional power handling capacity of the big Rola G12-PM, the Rola F742-PM is the ideal unit to use. Its flux density of 11,500 lines per square centimetre is as great as that of the larger model, yet its price is only 49/6. In other respects also the F742-PM is a remarkable speaker. The transformer is rendered damp proof and dust proof by means of a special metal and compound shield, whilst the use of the new magnet material "Alnico" greatly increases its efficiency without undue weight. For battery set or extension speaker use and for all replacement purposes where extreme sensitivity is desired, the Rola F742 should be selected. Write to-day for details.

Model  
F 742-  
PM 49/6

WITHOUT TRANSFORMER 42/-  
OVER 8 MILLION IN USE

# ROLA

The World's Finest Reproducers

THE BRITISH ROLA CO. LTD.  
MINERVA ROAD, PARK ROYAL, N.W.10.  
PHONE: WILLES DEN 4322-3-4-5-6.

# New Apparatus Reviewed

## Recent Products of the Manufacturers

### WEARITE UNIVERSAL MAINS TRANSFORMER

**WRIGHT AND WEAIRE, LTD.**, 740, High Road, Tottenham, London, N.17, have produced a new mains transformer that can be used in a variety of circuits. It will provide an HT supply of 250 or of 350 volts, as required, and LT voltages of 4, 5, or 6.3.

The choice of these three LT voltages allows for the use of present-day standard British valves, for the new Octal-base type and for American valves.

Two LT windings are included, the one for the rectifier, giving 4 or 5 volts at 2.5 and 2 amps. respectively, ten watts being the maximum loading for this winding.

The other LT supply is for the filaments of valves in the receiver, and a centre tapping is provided both on the 4-volt portion as well as on the 6.3-volt total. Our measurements show that with 4 volts output 4 amps. can be taken from the winding, making a total load of 16 watts. Thus on 6.3 volts eight of the 0.3-amp. valves could be used, or such combination that the total current is not more than 2.5 amps., so as to keep within the permissible loading of 16 watts.

The same conditions hold good also for the HT winding. With the full output voltage, i.e., 350-0-350 volts RMS, a maximum of 80 mA DC is available, making 28 watts output. Thus with 250-0-250 volts just over 100 mA of DC is available without exceeding the rated power output from this winding.

Some measurements of output were made, using the full 350-0-350 volts, and at 80 mA 335 volts were available after smoothing and using a 300-ohm choke. At 60 mA the DC voltage was 370, and at 40 mA the voltage was 400.

With the full load of 80 mA the output from each half secondary winding was exactly 350 volts RMS, there being no difference between the two.

When loaded to their full capacity all LT windings gave ostensibly the correct voltages; for example, the rectifier, a 4-volt type, received 3.97 volts, and the 4-amp supply was delivered at 4.04 volts. During

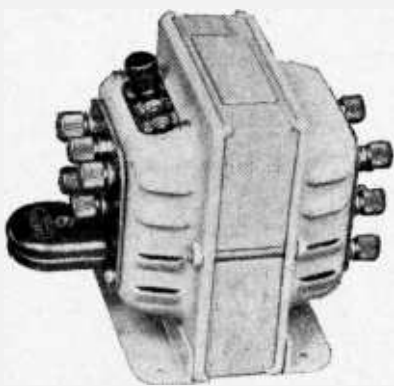

Wearite new Universal Mains Transformer.

the whole period of the tests the transformer remained perfectly cool and was absolutely silent in operation. It is a shrouded model, and louvres in the casing provide good ventilation. The primary is tapped for supplies of 200/210, 220/230 and 240/250

volts at 50 c/s. There is a neat mains selector plate fitted with an insulated screw for voltage adjustment, and all terminals have insulated leads.

The transformer is satisfactory in all respects and it fully justifies the designation of universal type. Well made and attractively finished in grey, it costs 25s.

### E.M.I. SERVICING ACCESSORIES

**DURING** the process of testing a receiver it is often necessary to disconnect some of the leads and substitute others either to isolate a particular part of the set or to test the chassis on the bench without having to remove such accessories as loud speaker and gramophone equipment from the cabinet.

Much time can be wasted in making up temporary leads and searching for clips and connectors. In order to lighten the work of the serviceman in this respect, E.M.I. Service, Ltd., Hayes, Middlesex, have in-



E.M.I. set testing accessories comprising plug clip and leads.

roduced a set of testing leads of adequate length to meet almost every requirement and all leads are fitted with a combined plug and clip at each end.

All leads are of different colours for easy identification, and, in addition, insulated sleeves are fitted at each end, and these are also colour-coded.

All leads are six feet long and the complete set includes aerial and earth leads, twin mains lead boldly marked with a red tag engraved "Mains," screened pick-up extension cable and an eight-core loud speaker cable.

The clips make secure contact either on wires, on soldering tags, or when used as plugs. They will fit sockets up to 1/4 in. in diameter. The price of the set is 17s. 6d. —Another useful accessory is the E.M.I. Combination Trimming Tool. One part consists of a box spanner on the end of an insulated hollow handle. In order to reduce capacity effects the minimum of metal is used. Its function is for adjusting trimmers having hexagonal heads.

The other part of the tool resembles a screwdriver in that it has a thin metal blade in the end of a long insulated shaft. This shaft fits inside the hollow handle of the box spanner portion and when assembled in this manner the tool can be used

for the adjustment of concentric trimmers of the kind in which the inner has a slotted head while the outer has a hexagonal nut. This very useful accessory costs 4s. 6d.

An ingenious device is the E.M.I. Tuning



E.M.I. combination trimming tool.

Wand. It is 1/4 in. diameter and 7 in. long; one end is coloured black and the other red.

If the red end is inserted into a coil and brought close to the winding the inductance is increased, while inserting the black end reduces it. It provides a ready means of checking the alignment and trimming of circuits without having to adjust the trimmers. It costs 2s.

Though intended primarily for the use of servicemen and test room workers amateur experimenters will find these E.M.I. accessories very useful.

## The Radio Industry

**RUNBAKEN** Electrical Products, 280, Deansgate, Manchester, 3, has sent us a leaflet describing a small electrical arc welder which has been designed to simplify welding and, it is claimed, can be used by anyone after a little practice. For occasional work there is a junior model at £15.

The Ever Ready cathode-ray tuning indicator type A39A has been reduced in price; it now costs 10s. 6d.

Postlethwaite Bros., Church Hill, Kinver, Stourbridge, send us details of H.F. chokes and slab type coils; skeleton, or stripped, chokes as usually supplied to manufacturers are now available for amateur use.

J. A. Crabtree & Co., Ltd., the well-known manufacturers of electrical fittings, has decided to give works employees a full week's pay in respect of the annual holiday period.

The Recordigram department of Linguaphone, Ltd., has been transferred to Phonodisc, Ltd., of Imperial House, 80-86, Regent Street, London, W.1. This latter firm is now manufacturing and distributing the combined reproducing-recording apparatus described in our issue of February 26th; in addition, an overseas model in a teak cabinet has been produced.

## GERMAN TELEVISION

### A Correction

**I**N our issue of July 30th we referred to the new standard proposed for German television and at the end of the note mentioned a price for sets. This price was included in error. No price has yet been fixed for German television sets, which will not be placed on the German market for some time yet.



# The Wireless World

THE  
PRACTICAL RADIO  
JOURNAL  
27<sup>th</sup> Year of Publication

No. 938.

FRIDAY, AUGUST 20TH, 1937.

VOL. XLI.

No. 8.

Proprietors: ILIFFE & SONS LTD.

Editor:  
HUGH S. POCOCK.

Editorial,  
Advertising and Publishing Offices:  
DORSET HOUSE, STAMFORD STREET,  
LONDON, S.E.1.

Telephone: Waterloo 3333 (50 lines).  
Telegrams: "Ethaworld, Sedist, London."

COVENTRY: Hertford Street.

Telegrams: "Autocar, Coventry." Telephone: 5210 Coventry.

BIRMINGHAM:

Guildhall Buildings, Navigation Street, 2.  
Telegrams: "Autopress, Birmingham." Telephone: 2971 Midland (4 lines).

MANCHESTER: 260, Deansgate, 3.

Telegrams: "Iliffe, Manchester." Telephone: Blackfriars 4412 (4 lines).

GLASGOW: 26B, Renfield Street, C.2.

Telegrams: "Iliffe, Glasgow." Telephone: Central 4857.

PUBLISHED WEEKLY. ENTERED AS SECOND-  
CLASS MATTER AT NEW YORK, N.Y.

Subscription Rates:

Home, £1 1s. 8d.; Canada, £1 1s. 8d.; other  
countries, £1 3s. 10d. per annum.

*As many of the circuits and apparatus described in these  
pages are covered by patents, readers are advised, before  
making use of them, to satisfy themselves that they would  
not be infringing patents.*

## CONTENTS

	Page
Editorial Comment .. ..	157
New Receiver Designs .. ..	158
Mains-Driven Types .. ..	158
Battery Models .. ..	162
Special Sets and Portables .. ..	163
Loud Speakers and PA Equipment .. ..	165
The Television Programmes .. ..	165
The Wireless World Straight Six .. ..	166
30-watt PA Amplifier .. ..	169
Television and Cathode-Ray Gear .. ..	170
Guide to Stands and Exhibitors at Olympia .. ..	172
Receiving Aerials .. ..	174
W.B. "Planoflex" Loud Speaker .. ..	175
Listeners' Guide for the Week .. ..	176
The New Valves .. ..	178
Random Radiations .. ..	179
Components and Accessories .. ..	180
On the Short Waves .. ..	184

## The Show Retrospect and Forecast

**N**EXT Wednesday, August 25th, the Annual Radio Exhibition at Olympia will open its doors, and this issue, as well as the two which follow, will be largely devoted, as in previous years, to reviewing the Show and giving our readers as comprehensive an account as possible of all that we find of novelty or special interest.

The present issue will give to readers a general idea of what they may expect to see. Next week a more complete account, dealing with exhibits on individual stands, will be included, whilst our third Special Show Number will discuss technical developments in various branches of the industry.

Annual radio exhibitions in London have now been held with an unbroken record since 1922, and it is extremely interesting to look back at the pages of *The Wireless World* reporting the first radio exhibition and make comparisons with the Radio Show to-day. Hardly any sets of those days attempted to camouflage themselves as furniture. There were no sets operating from the electric supply and, in consequence, provision had to be made for terminals for the accumulator and high tension battery which were normally separate units, and generally stood on the floor beneath the table accommodating the set, with leads connecting them. The loud speaker, too, was a separate unit, but with the majority of sets of that date headphones were used and only the more ambitious receivers had provision for a loud speaker. Perhaps the most interesting comparisons of all are on the basis of price, for in that year we find the crystal set, with headphones and no valves, priced at £7 12s. 6d., whilst for a two-valve receiver with 'phones £20 seemed to be a fair average price. When we consider what this sum will buy to-day, we begin to appreciate what progress has been made.

The character of our annual exhibitions has gradually undergone a change; up to the last two or three years it had been the general practice of set manufacturers

to make the Radio Show the occasion for launching new designs, but now the policy adopted is to make these changes all the year round and not to withhold new models until the Show, but rather release them at intervals throughout the year. As a result, readers may find that the Exhibition contains less of outstanding novelty and that our Show numbers tend to become a record of the year's progress rather than pages of startling new disclosures.

Last year we expressed the view that prices were so low that it was an exceptional year in which to obtain value for money. Slight increases in the prices of most sets have been announced this season, rendered necessary because of the higher cost of raw materials. We believe that in the better class sets and in television receivers the public must not look for lower prices in the future, but rather that there may be a tendency for prices to go up. In many of the better sets produced for this season it can be noted that a more generous use of valves has been adopted, not so much to increase amplification, which seems to have reached a useful limit, but to introduce many refinements depending upon extra valves for their operation.

### Television

Last year television was introduced into the Show without much enthusiasm on the part of the manufacturers, but a year of work and experience has created more optimism and television will this year be a feature of the Show, with fourteen firms giving daily demonstrations for the benefit of visitors.

*The Wireless World* television receiver will be on view at our Stand No. 7, where provision has been made to enable the details to be studied. Finally, the attention of readers is specially directed to the "Straight Set" described in this issue, which will also, with other *Wireless World* apparatus, be exhibited on our stand.

## THE OLYMPIA SHOW

AUG. 25th to SEPT. 4th

(11 a.m. to 10 p.m. Daily)

## New Receiver

At last year's Show the all-wave receiver was still in the nature of a novelty: this year it is to be the standard British domestic receiver, and accordingly the number of classes into which the various sets are divided for convenience of reference is somewhat reduced. Under the general heading of "Mains-Driven Receivers" we describe the principal productions of manufacturers in this, the most important, field, while battery sets and television receivers are dealt with under appropriate headings.

Under the heading of "Special Purpose Receivers" we describe various kinds of sets that do not readily fall into the other classifications. In this class are included portables, sets operating on self-contained frame aerials and, in fact, everything that differs in any essential particular from the more or less standardised broadcast receiver or radiogramophone.

It will be found that our classification of receivers by number of valves sometimes differs from that of the makers, as we do not count rectifiers in the total. Again, the position in this matter is further complicated this year by uncertainty as to whether cathode-ray tuning indicators with an amplifying triode should be included.

Although in many cases the table models have been chosen for detailed description, it should be realised that the same chassis is often available in radiogramophone form.

## MAINS-DRIVEN RECEIVERS

AGAIN, the so-called "small superhet" is clearly to be the mainstay of the British broadcast receiver industry for the coming season. Although this description is generally used, there seems to be no definite and generally accepted definition for it; most of us envisage it as an arrangement of a frequency-changer (without signal-frequency RF amplification) followed by a single IF stage, second detector and output valve, with or without an intermediate AF stage. Incidentally, such a stage is now to be found more generally than last season.

As a general but not inflexible rule, we must regard a set as at least on the point of emerging from the "small superhet" class when it includes an RF stage; generally this addition entitles it to be called a "big one." Again, there is a tendency for some of the sets with what is basically

a "small" circuit to sprout auxiliary valves and refinements to such an extent that it would be hardly fair to describe them as anything but "big." All this

crease in the prices (seldom amounting to more than 5 per cent.) of broadcast receivers, the visitor at Olympia will have little to complain about on the score of value for money. An AC superheterodyne for 7 gns. sounds like a distinct bargain; such a set is offered by Philips. It embodies an octode frequency-changer, one IF stage, a double-diode-triode and a

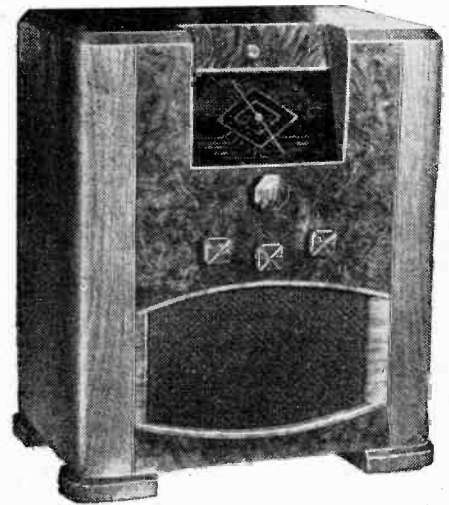

Invicta Model 310.

pentode; three wavebands are covered and the specification is, in fact, quite a full one, including two band-pass filters in the IF amplifier and one in the RF input circuit. An AC/DC model costs 7½ gns. Cheapness is attained in these sets not so much by simplifying the circuit as by adopting an economical method of construction. Mullard produces a similar AC set at the same price, while an even cheaper superheterodyne is the two-band Lissen Model 8301, which includes three valves and costs £6 17s. 6d. Full details of the circuit arrangement are not yet available.

Output from the power stage of the new season's sets is distinctly on the up grade; the G.E.C. "All-wave Quality 8," a rather ambitious receiver with a radio-frequency stage and push-pull triode output, delivers 6 watts to the loud speaker.



G.E.C. "Fidelity All-wave 8" Radio-gramophone.



R.G.D. Console Model 628.

may serve as a warning to the reader that no attempt will be made here to divide the new season's sets into watertight compartments.

All-wave sets are now the rule rather than the exception, although the smaller models generally include only one SW band. More ambitious models have several; so far as can be determined at the time of writing the record will be held by the Milnes "Venus" model, with a total of eight bands (including medium and long).

Although there has been some small in-

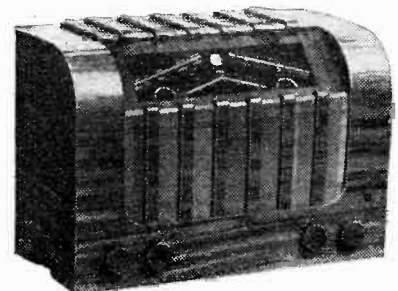

Pye Model QAC3, a 3-band superheterodyne.

# Designs

## A PRELIMINARY SURVEY

*Although the Show does not open until next Wednesday, "The Wireless World" technical staff have already been able to gather sufficient information to form a useful opinion on general tendencies of design and to present a balanced forecast of the principal manufacturers' activities.*

This is a three-band set; another model, the "All-wave 8," has an extra short-wave band and covers wavelengths from 13 metres upwards. It is built to a "tropical" specification and is the most sensitive set of the G.E.C. series.

Another set with a large output is the Ace four-band model covering wavelengths from 11 to 2,000 metres and using double-triode valves in push-pull which give an output of 12 watts. An RF stage, pentagrid frequency-changer with separate oscillator valve and phase-reversing AF stage are employed. In one of the Alba models, eight watts is obtained from an output pentode; the frequency-changer is a triode-hexode and iron-cored coils are used, as in so many of the present season's sets.

An output of eight watts is also given by the new Kolster-Brandes KB660, a 5-valve set covering wavelengths from 12.5 metres upwards in four steps. There is no RF amplifier in this receiver, but its sensitivity should be well above the average as two IF stages were provided; there are nine tuned circuits in all, and many refinements, including automatic tone compensation and optional muting. This set, which costs 16½ gns., is, like all KB productions, designed for use with the new Rejectostat all-wave anti-interference aerial.

In the Invicta Model 330 a Magnavox Magna speaker is fed with 8 watts from the output stage. This set has a signal-frequency stage and costs 17 gns. Other

RF stage, automatic tuning control, a sound-pressure balancing chamber for improving bass reproduction, and a four-position variable selectivity control. Almost as a matter of course, push-pull and resistance-coupling are employed at the audio-frequency end, with triodes in the output stage.

Outwardly, the majority of receivers are very much as they were, but there are several interesting departures from standard practice, all introduced with the object of making the sets more convenient to operate. H.M.V. have introduced what is described as an "armchair" model, in the form of a bookcase

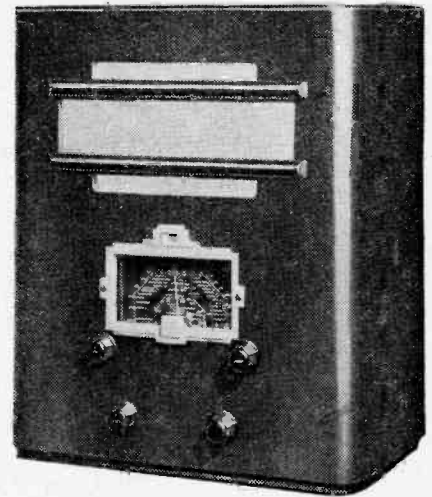

A straight TRF receiver—the Ever Ready Model 5027.

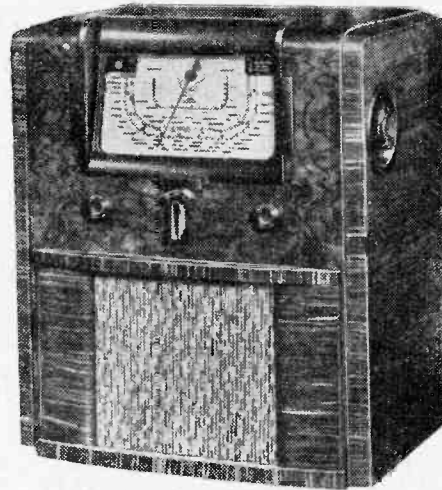

The Corsor 584, a medium-priced receiver with variable selectivity.

combined sideboard and bookcase, and a cocktail cabinet.

Convenience of operation in other directions has evidently been studied by many designers. A case in point is the tuning system of several of the Ekco receivers, well exemplified by the Model AW88. The innovation is described as "spin wheel" tuning. The controls are rotated by means of a milled edge disc somewhat similar in appearance to the edgewise thumb-operated disc device of a few years ago. Here the resemblance ends, however; the new device is on much more ambitious lines, the drive being

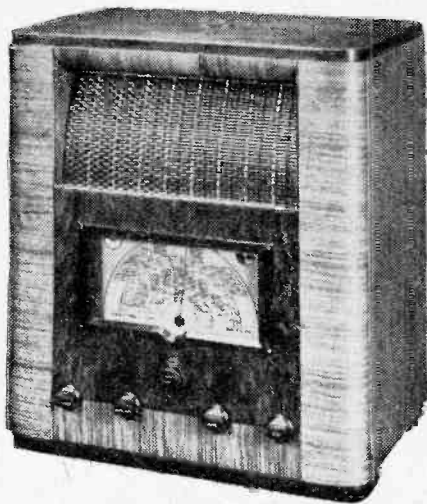

H.M.V. Model 469 has an output of 5 watts.

receivers in which exceptionally large undistorted output is provided are to be shown by Beethoven, Ekco and Mullard.

Contrast expansion is apparently not to figure generally at the Show, but will be found in at least one model—the R.G.D. 1220 radiogramophone at 120 gns., which is likely to be one of the most ambitious sets to be seen. It embodies a total of twelve valves and includes an

with a flat glass-covered top which forms a convenient table. The chassis built into this cabinet is an ambitious one, covering five wavebands and having the features of variable selectivity, station-name calibration of all three short-wavebands and provision for an anti-interference aerial. Nine valves plus a rectifier are used. The same chassis is built into a table cabinet and is also available as a self-changing radiogramophone. A similar chair-side model is to be shown by Marconiphone, while Alba has also introduced the armchair cabinet idea, several different chassis being available in this kind of housing. One of the more ambitious sets that is obtainable in this form is a four-band superheterodyne (12-2,000 metres) with a radio-frequency stage and triode-hexode frequency-changer which costs 22 gns.

Texaloom is also showing receivers of unconventional outward form which are described as "radio furniture." An eight-stage all-wave superheterodyne covering three wavebands is built into a bookcase.

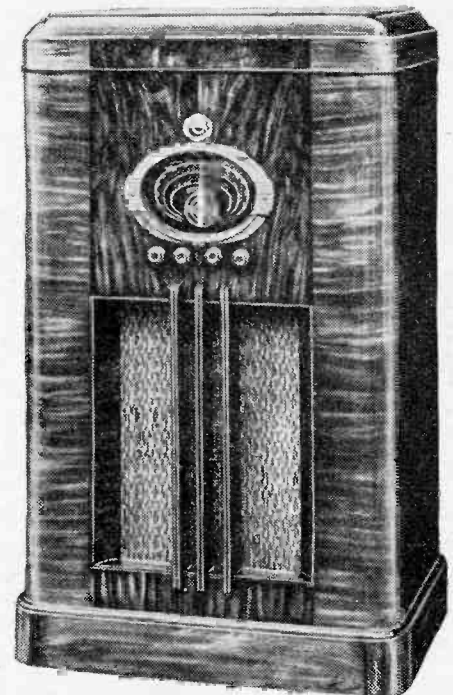

British Belmont Radiogramophone Model 721.



**New Receiver Designs—**

transmitted through a heavy flywheel, matters being so arranged that the whole tuning scale can be covered with a minimum of effort on the part of the user.

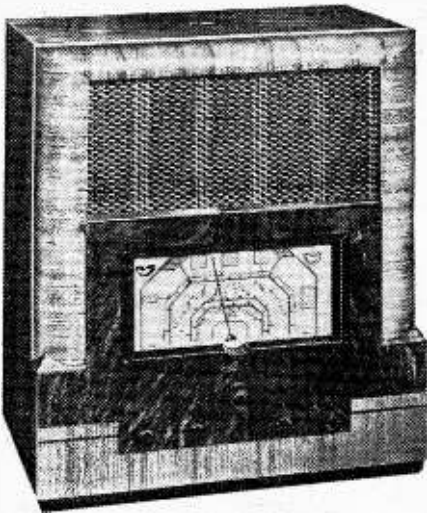

The Marconi 5-band receiver covers wavelengths from 4.85 metres upwards.

The particular model in question is a 12½-gn. AC superheterodyne, covering an exceptionally wide tuning range which includes the television channel. Inverse feed-back is employed for the purpose of increasing the undistorted output. Another model, at 16 gns., has still more circuit refinements and gives an output of eight watts, but retains the conventional tuning system.

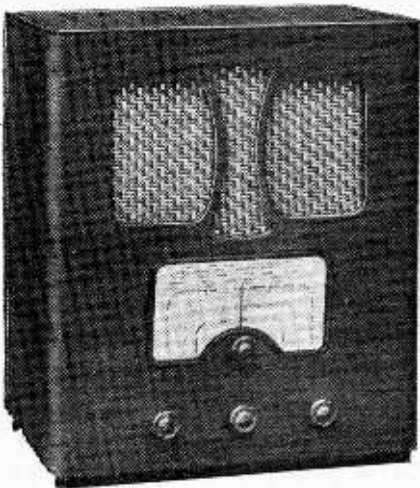

Alba Model 801 AC, an all-wave TRF receiver.

Indicating scales are generally much clearer and easier to read; in the Portadyne A58, the scale itself is changed automatically by operation of the wave-range switch. This particular set, which costs 11 gns., includes triple-tuned IF couplings and so has an exceptional number of circuits for its type. Flywheel tuning, of the type with which most readers will already be familiar, is included in the Halcyon sets; a typical model, the U6801, which includes this device, has an exceptionally clear 14-inch scale and employs parallel pentodes in the output stage. Adaptations of the "Giant Dial"

idea will be found in several of the current season's models to be shown by McMichael.

A new activity of Whiteley Electrical, the well-known makers of Stentorian loud speakers, is the production of a series of receivers. One of the Stentorian sets is a four-band superheterodyne with an ingenious arrangement providing individual scales with station names for each wave-band.

In the matter of general lay-out, a number of minor changes will be noticed, while a somewhat sweeping departure from conventional practice will be seen in the Beethoven table models, on which no knobs are visible, the control panel being at the top of the cabinet and concealed by a lid.

Iron-cored tuning coils generally figure more largely than ever before in signal-

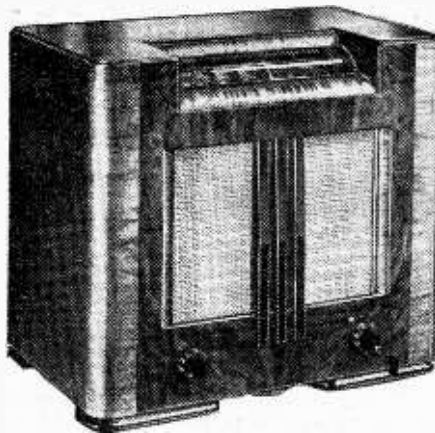

The tuning scale of the Portadyne A58 is automatically changed by operation of the wave-range switch.

frequency and IF circuits. An example of their use will be found in the Aerodyne TRF four-band set with a three-valve circuit; models for AC or AC/DC are produced.

Generally speaking, sets do not tend to get any smaller, although "compacts" are shown by British Belmont both in TRF and superheterodyne models at £5 10s. and £5 12s. 6d. respectively. An example of the opposite tendency will be found in the Bush SW45, where, mainly from the acoustic point of view, the cabinet has been planned on unusually generous lines. This set is a three-band model with RF stage, seven tuned circuits and the large output of 5 watts.

Although the short-wave coverage of the

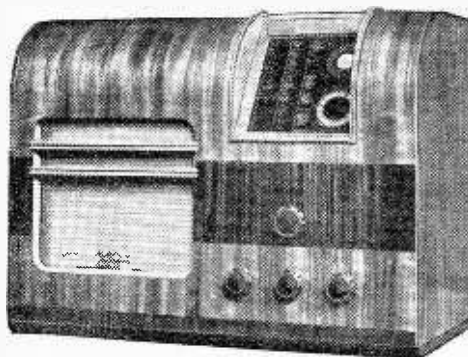

Bush Radio all-wave superheterodyne.

small three-band models remains much as it was—about 16-50 metres—there is, as already mentioned, a distinct tendency to provide much wider range. Of the eight bands provided in the Milnes "Venus,"

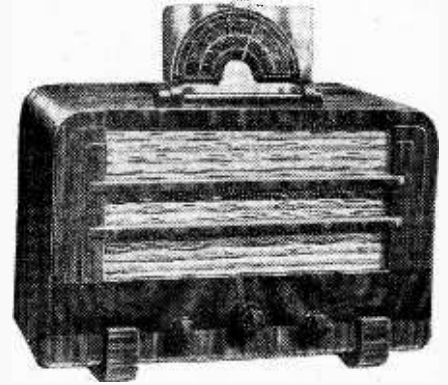

Ultra Model 121, with external tuning scale.

six are short; in this set eight watts output is obtained from a pair of pentodes, while there is single-knob control of tone, selectivity, noise suppression, tuning corrector and dial light. In the Marconi-phone Model 564, an attractive console set giving from 10-12 watts output, there are five wavebands starting from 4.85 metres.

Wide coverage in a somewhat different sense is given by some of the Burndept models. In the seven-valve set, for instance, the coverage between 13.5 and 2,000 metres is complete except for one

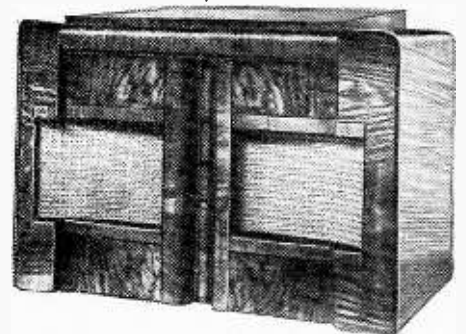

Beethoven twin-speaker receiver with concealed control panel.

gap from 580-750 metres; reception of the trawler and 160-metre amateur transmissions is thus possible. This particular set has an RF stage, a triode-hexode frequency-changer, a separate valve for noise suppression and an electron-coupled output stage giving five watts; it costs 18 gns.

In the Pilot U106, the lowest wavelength is 4.5 metres; there are six bands in all and the output is 14 watts. The Pye QAC5 is a five-band set tuning from 5.8 metres upwards, and thus covering the television sound channel. This is a 5-valve receiver with a four-position tone control and flywheel tuning to allow the scales to be traversed rapidly. Finally, there is the Belmont 8-valve superhet, tuning from 6.2 to 2,150 metres and delivering an output of eight watts.

Variable selectivity is included in a number of the more ambitious instru-



**New Receiver Designs—**

ments, including the R.G.D. productions already mentioned, but it is seldom to be found in the lower-priced sets. An exception to this rule will be found in the Cossor Model 584, in which an ingenious mechanical system of adjusting the inductive relationship of primary and secondary of the first IF transformer is to be found. The second IF transformer is aligned by movement of its iron core, and not by the conventional method of adjusting trimming condensers. There are several other interesting constructional features in this set, which is a three-band model with a triode-hexode frequency-changer; its price is 13 gns. In a cheaper set, the Model 484 at 9 gns., the increase of selectivity that is almost invariably required when receiving distant stations is automatically provided; this seems to be a highly practical arrangement. In this set, intermediate frequency amplification is

Dynatron sets, which are designed essentially to combine facilities for long-distance reception with high-quality reproduction, are now arranged to function with a straight circuit for short-distance work, while they operate as superheterodynes when extreme range is required. The most ambitious Dynatron model is a radiogramophone with seventeen valves and a total of fourteen tuned circuits. An external Voigt speaker is fed from an

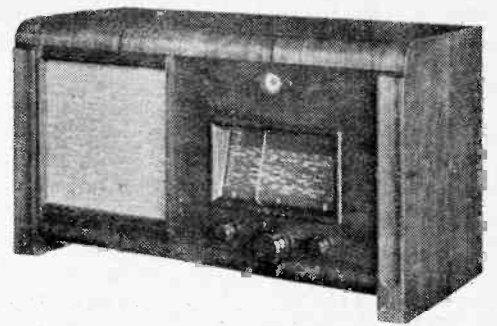

The Kolster-Brandes KB660 gives an output of eight watts.

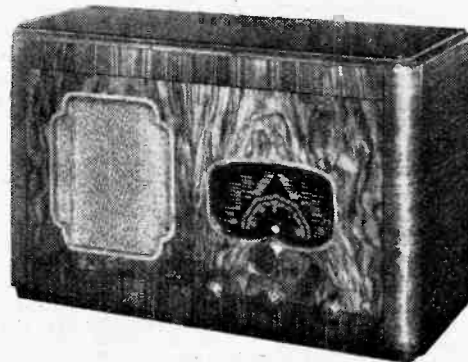

Ace Radio Model 73AC.

triode output valves will be found in a few low-priced sets as well as in most of the more ambitious models. A triode is used in the Ever Ready three-band four-valve Model 5029, which includes an RF stage and costs £13 19s. 6d.

Twin loud speakers are fitted to several medium-priced table models. Examples

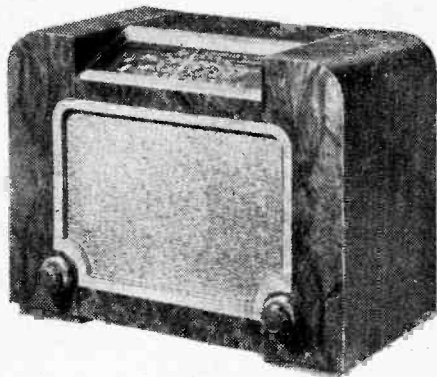

Mullard MAS7 3-band superheterodyne.

provided by regeneration between anode and grid circuits of the second detector, there being no IF amplifier in the usual sense.

"Straight" or TRF sets are still well to the fore, and few manufacturers with an extensive programme will fail to show a model in this class. More often than not this season's TRF receiver includes one or two short-wave ranges; an example is the Vidor three-valve receiver covering wavelengths from 16 metres upwards in three steps. This sets costs £6 19s. 6d.; there is also a four-band model tuning down to 13.5 metres which is priced at £9 7s. 6d. In the G.E.C. AC38, which covers two bands, sensitivity is increased by the provision of pre-set reaction.

The firm of Dynatron, which has hitherto been unwavering in its support of the "straight" principle, has this year introduced an interesting compromise.

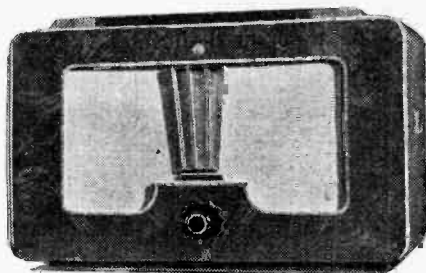

Philips 7-valve all-wave receiver.

output stage giving 15 watts, and variable selectivity is provided.

The more specialised Haynes Radio sets, which also employ the TRF principle, are dealt with elsewhere in this forecast. There is also to be a straight standard radiogramophone with two RF stages (four tuned circuits) and a separate amplifying valve for purposes of AVC. There is a combined and inter-dependent ad-

Ekco AW88, with the new "spin-wheel" tuning system. The close-up shows the large milled-edge disc through which the Ekco "spin-wheel" tuning system is operated.

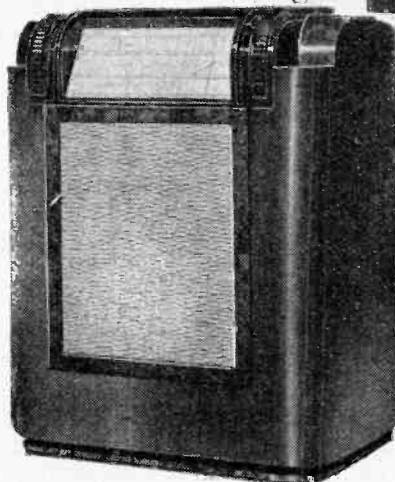
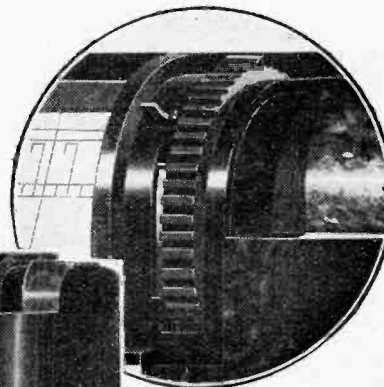

justment of sensitivity and selectivity—as sensitivity is increased the acceptance band width is automatically narrowed. This receiver can be modified to cover the television channel if required.

In spite of the introduction of improved pentode valves, negative feed-back, etc.,

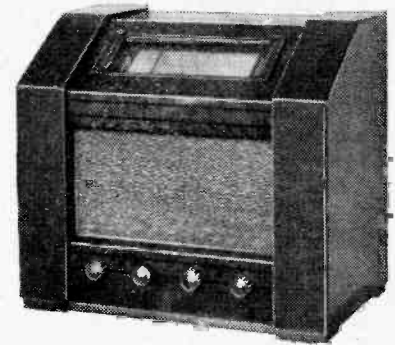

Aerodyne Model 291.

of this will be seen in the McMichael five-valve eight-stage superheterodyne costing 14½ gns., and in the Beethoven AC852, which has bass and treble compensation; this set has already been referred to in describing the concealed control panel peculiar to Beethoven table receivers.

Universal models of a large proportion — perhaps the majority — of the receivers described here are available; the AC/DC interchangeable set has now completely displaced the purely DC type. Some manufacturers provide an AC/DC alternative for each AC model throughout their range; so far as table models are concerned, this practice is followed by Ultra. The Ultra 121, in AC form, costs £13 2s. 6d., while its AC/DC counterpart is priced at 13 gns. These sets have a large and easily readable tuning scale mounted externally at the top of the cabinet; they cover three wavebands and are fitted with iron-cored coils in both signal-frequency and IF circuits.

Extra valves are now employed more freely than hitherto for what may be described as auxiliary purposes. In the Philips 787AX, for example, there are two double-diode-triodes which between them perform the functions of detecting,

**New Receiver Designs—**

gramophone amplifying, AVC and AF amplification. This receiver, which costs 19½ gns., has parallel pentode output valves.

Inverse (or negative) feed-back as an aid to the attainment of greater undistorted output appears to be gaining in favour. Among the sets in which it will appear is the Mullard MAS8, an all-wave superheterodyne costing 15 gns., which incidentally embodies the feature of single-knob control of tuning, volume, tone and

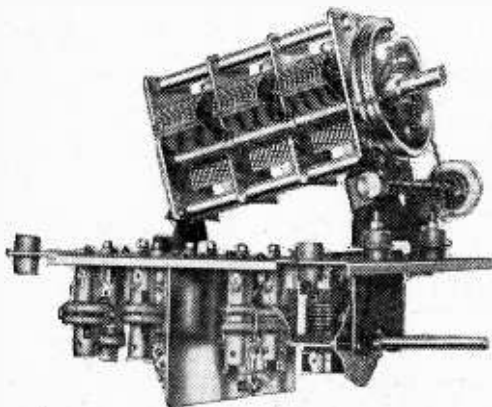

Flexibly mounted condenser and sub-chassis of the Cossor 584.

selectivity. The loud speaker is fitted with a small auxiliary diffusing cone for eliminating the beam effect on high notes. Another set with negative feed-back is the Ekco Model AW88, which has already been described.

## BATTERY RECEIVERS

AMONG the receiver exhibits at Olympia this year, battery sets will be by no means overshadowed by mains receivers either as regards numbers or ingenuity of design. Neither will they be found to conform to any one given type, for their circuits range from the simple and inexpensive three-valve "straight" receiver to superheterodynes incorporating all the

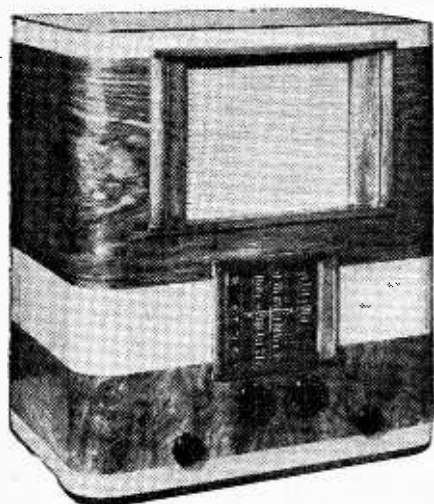

Bush all-wave battery superheterodyne, Model BA43.

refinements of the most advanced mains models.

Of the simpler three-valve TRF re-

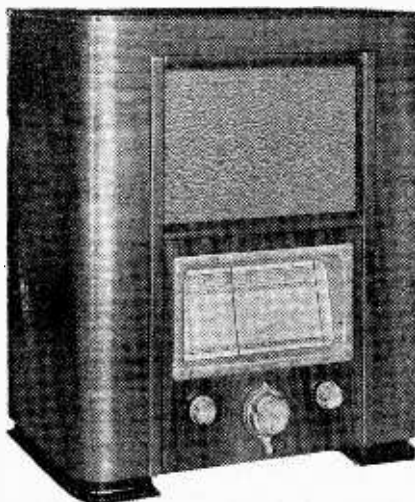

Kolster Brandes KB610 battery superheterodyne with alphabetical dial.

ceivers designed to cover the medium and long-wave broadcast bands only, we may quote the Alba Model 210, the Ekco B38 in moulded cabinet, the Ever Ready Type 5028, the G.E.C. Model SP3 in brown cellulose cabinet, and the H.M.V. Model 167 as good examples.

Many sets of this type incorporate a wave-trap for Droitwich to improve



G.E.C. All-wave Battery 4, with automatic bias.

selectivity when receiving other stations on the long-wave band, and in this category are included the Invicta Model 420 and the Mullard MB3B.

Other sets rely on a band-pass filter to achieve the necessary selectivity, and examples which will be found at Olympia include the Pye Q70, Halcyon B333, and the Invicta Model 340.

Automatic bias is a refinement which we do not expect to find in the cheaper battery sets, but the Lissen Model 8306, at £5 12s. 6d. with batteries, includes this feature. The Aerodyne Model 297 has band-pass tuning as well as automatic bias.

The "straight" three-valve battery set is no mean performer on the short waves, and there are quite a number of sets incorporating a short-wave band in addition to the usual medium and long waves. Of

these the Alba Model 310, which has band-pass tuning on the normal broadcast bands, and the Pye Type QTRF, which has a Droitwich filter, both tune down to the 16-metre broadcast band. Sets made by Burndept and Vidor are interesting for the fact that two separate short-wave bands are included, the lower of which goes down to 13.5 metres. In the Vidor CN268, at £8 2s. 6d. including batteries, a single pentode is used in the output stage, and the CN269, at £9 7s. 6d., is virtually the same circuit with a QPP stage. The Burndept CN270 has an interesting feature in the tuning control, which automatically illuminates the scale when the control is in use. The price of this set is £8 5s., including batteries.

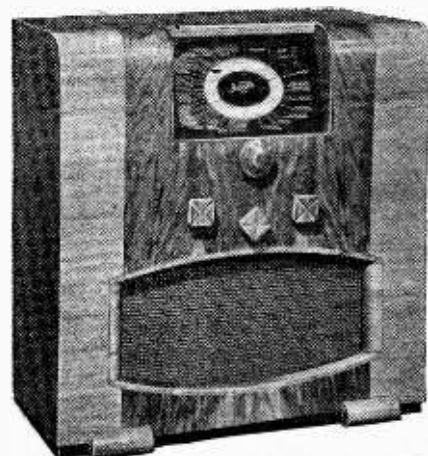

Invicta Model 390 battery receiver with tone-compensated volume control.

Sets which cover the 19-metre short-wave broadcast stations, but do not go down to 16 metres, include the H.M.V. Model 149, the Decca Model 33, and the KB Model 620.

Numerically, by far the most important section among battery receivers is that which includes sets functioning on the superheterodyne principle. Generally four or five valves are employed, and the sets may be divided into roughly two equal groups according to the type of output valve used. A single pentode is popular on account of its economical current consumption, and will be found in the Model AW53B of Ace Radio, the Alba Model 320, the Milnes "Saturn," the Mullard MBS3,

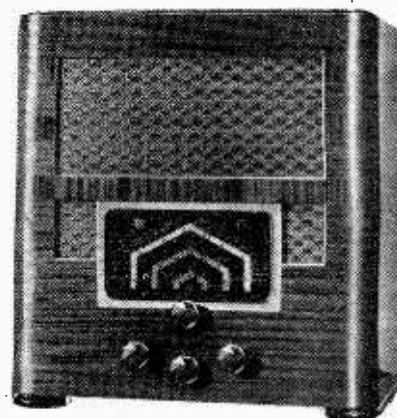

The Pye QB3 battery superheterodyne has a QPP output stage with reverse feed-back.

**New Receiver Designs—** and the Philips 716B. All these sets tune down to the 19-metre broadcast band, and it is worth noting that the Milnes set is

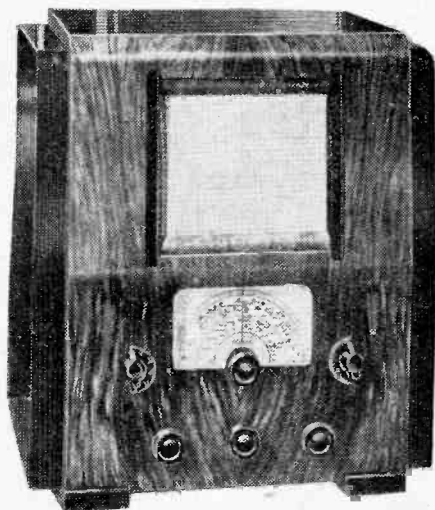

Six full-scale sections cover the short-wave band in the Milnes "Onyx" receiver.

provided with automatic bias. The Philips receiver has five valves, one of which is a separate triode oscillator, and its construction is unconventional for a battery receiver, inasmuch as the chassis is divided into two parts which are mounted vertically against the sides of the cabinet.

Other receivers with a single pentode output stage include the Bush BA43, which has a five-valve circuit and tunes down to 17 metres, the G.E.C. Battery All-wave 4, with automatic bias, "Touch Lighting," and a lower waverange limit of 16 metres, and the KB Model 610,

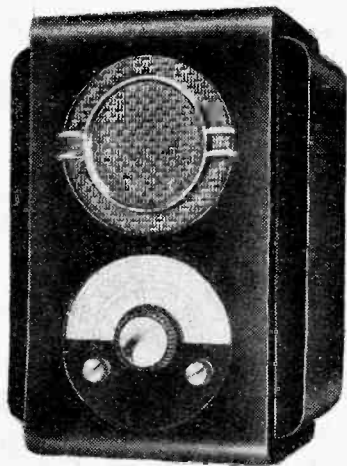

Ekco Model BV78 "No HT" receiver which now includes a short-wave range.

incorporating the latest "Alphadex" dial and tuning down to 16.5 metres. Sets with single pentode output valves which tune down to the 16-metre broadcast band also include the Portadyne B48 and the Ultra Model 105.

Ultra also make a four-valve superheterodyne, Model 123, going down to 16.8 metres with a QPP stage. The Pilot Model B344, with a four-valve circuit, also includes a QPP output stage designed to deliver 2 watts.

Apart from the inclusion of a QPP out-

put stage, the following sets are notable for special features, either of an electrical or a mechanical nature. The Invicta Model 390, for instance, has a tone-compensated volume control, and its lowest wavelength is 16.5 metres. The Ekco BAW98, which tunes down to 19 metres, has automatic bias and "spin wheel" tuning. The new McMichael Model 378 also has a form of flywheel tuning and a five-valve circuit tuning down to 19 metres. A separate triode oscillator is used in the Philips Type 714B, which is a development of the Type 716B previously mentioned. It tunes down to 19 metres, and is capable of reception on a plate aerial fitted inside the cabinet.

An unusually comprehensive circuit is employed in the Cossor Model 583, which tunes down to 16 metres. A separate oscillator is provided, and variable selectivity is included in the IF stage.

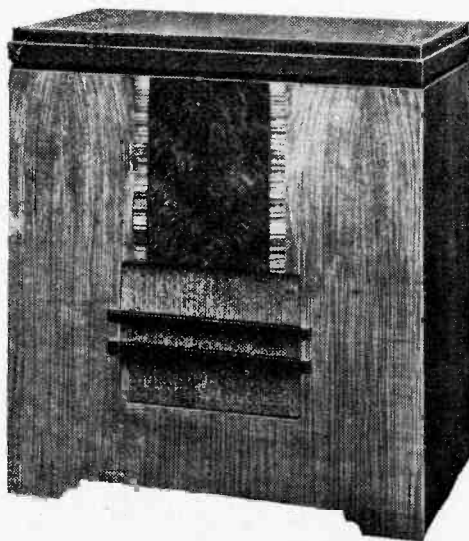

A battery-operated radio-gramophone, the Alba Model 455.

Reverse feed-back is applied in the QPP output stage of the Pye QB3 receiver. A four-valve circuit is employed, and the tuning range goes down as low as 15.5 metres. In the Ever Ready Models 5030 and 5034, which tune down to 18 metres and 19 metres respectively, Class B amplification is used in the output stage.

The Milnes "Onyx" receiver is interesting not only for the fact that separate pentodes are used in the output stage under Class AB conditions, but also for the fact that the short-wave range (12.5-51 metres) is divided into six bands each expanded to occupy the whole length of the tuning scale. Another unusual feature of the circuit of this receiver is that a hexode valve is used in the IF stage.

The Model 166 H.M.V. receiver is a five-valve superheterodyne tuning down to 18 metres, and the output stage is designed for separate valves of the pentode or tetrode type in push-pull. Separate stages in push-pull are also used in the Halcyon B691, which is a six-valve superheterodyne, tuning down to 16.5 metres and incorporating the flywheel drive and large rectangular dial which have been a feature of Halcyon receivers for some time.

From the circuit point of view, one of the most interesting of the battery sets is the Cossor Model 483, in which there is no valve amplification at the intermediate frequency, but in which a special filter is employed, giving bandpass tuning on the normal broadcast bands and a single tuned circuit of high L/C ratio when the short-wave band is in use.

This year the Ekco "No HT" battery receiver with a vibratory rectifier has been extended to include the short waves and tunes down to 19 metres.

Finally, we would draw attention to what is, we believe, the only battery-operated radiogramophone in the Show. This is the Alba Model 455, with a circuit similar to that of the Type 320 table model. It is fitted with a Garrard double-spring motor, and the price is 18 guineas, less batteries.

## SPECIAL PURPOSE RECEIVERS

**E**QUIPMENT which comes under this heading is somewhat varied, for "Special Purpose" is rather an elastic term and can be taken to cover any receiver which does not fall into the accepted categories. Portable types are not now shown in sufficient numbers to merit a section of their own, and this is rather surprising in view of their undoubted convenience, especially at holiday times.

Those who require such sets, however, will find a considerable choice on the Lissen stand, for there are three different models. The cheapest is the "Picnic Portable" at 9 guineas. An RF stage is used with a grid detector and two resistance-coupled AF amplifiers. The apparatus is completely self-contained and includes a frame aerial. The Model 8164, at £10, is of similar design but includes a Class B output stage.

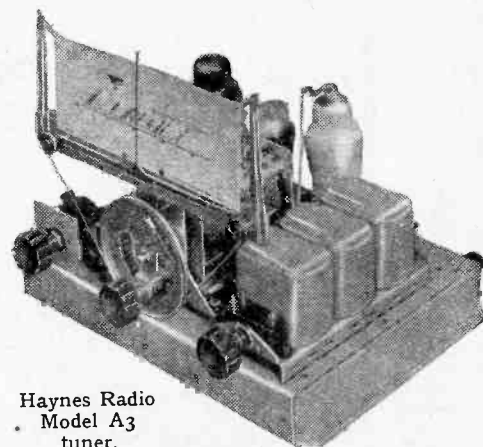

Haynes Radio Model A3 tuner.

The Model 8303 is, perhaps, a trans-portable rather than a portable, for it is AC operated. It is a three-valve set with one RF stage, a triode grid-detector and a pentode output valve. It can be used with a pick-up and is priced at £10 15s.

An ambitious transportable with five valves, apart from the rectifier, is shown by the G.E.C. It is a superheterodyne covering the medium and long wave-



**New Receiver Designs—**

bands; an RF stage precedes the frequency-changer, AVC is fitted, and there is a 3-watt output stage. It is priced at 16 guineas.

A five-valve battery-operated portable is shown by Bush Radio. This is the BP5 at 13 guineas, and it is a superheterodyne covering the medium and long wavebands. An octode frequency-changer is used and preceded by an RF pentode amplifier; there is one IF stage and a duodiode-triode detector and AF amplifier feeds the output pentode.



The Pye Baby Q portable.

The Pye Baby Q is a portable of small dimensions but including four valves. There is one RF stage and a grid detector followed by a triode AF amplifier which is transformer-coupled to the output pentode. The set is priced at 8 guineas.

An all-wave portable is shown by Beethoven. This is the Model AD303, and it covers 16-50, 200-550 and 900-2,000 metres. It is a superheterodyne with a 2½-watt output stage, and it is fitted with AVC. Its price is £10 17s. 6d., and it is designed for AC/DC operation. This firm is also showing a number of small battery portables.

The McMichael model 374 is an all-wave transportable of the six-valve type. AVC is included with a cathode-ray tuning indicator. It is priced at 16 gns. A number of battery portables is also shown by this firm.

Among the exhibits of Haynes Radio is a Local-Station Quality Tuner, type A3. This is a three-valve unit with one RF stage, diode detector and one triode AF amplifier. An input band-pass filter is used and the three tuned circuits embody

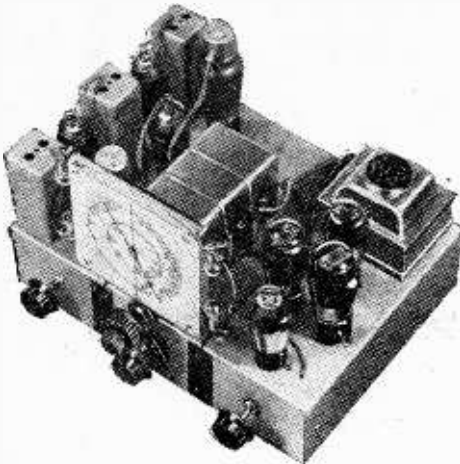

B.T.S. All-wave superhet chassis.

iron-cored coils; no reaction is employed but in spite of this the sensitivity is adequate for the reception of a number of Continental transmissions. The unit is priced at £7 17s. 6d., and is intended for use with one of the amplifiers manufactured by this firm.

Another tuner is the Model R3. On the medium and long waves this is a straight set with two RF stages and four tuned circuits. A diode detector is used and followed by a triode AF amplifier. Another triode gives amplified AVC. In addition to the normal broadcast bands this tuner covers 7.2-7.26 metres on the ultra-short waves, thus enabling the sound accompaniment to television to be received. Two extra valves are included for this range; one is a high-slope RF pentode which functions as an RF amplifier, the other is a triode-hexode which acts as a frequency-changer. This unit is priced at £18 10s., and it is available without the ultra-short-wave band as Model R3 at £15 10s.

A number of complete receivers in chassis form is shown by the Armstrong Mfg. Co. These are all superheterodynes

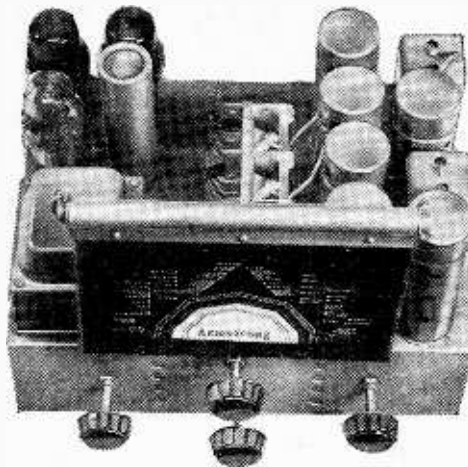

Armstrong superheterodyne with push-pull output stage.

and the nine-valve model is available in two forms, one with a tuning range continuous from 11 metres to 550 metres for Colonial use, and the other with the long waveband but without one of the short wave-ranges. This set is priced at 13 guineas and is for AC operation; iron-cored IF transformers are used and the 12-watt output stage is fitted with triodes in push-pull.

A six-valve model has three wavebands, the short-wave range extending down to 17.9 metres. An intermediate frequency of 465 kc/s is used and the set is fitted with a 4-watt triode output valve. Octal-base type valves are used and the chassis, complete with valves and speaker, costs 8 guineas. A similar set with a push-pull output stage delivering an output of 10 watts is priced at 10 guineas.

British Television Supplies have several superheterodynes of the all-wave type which are available in chassis form. They are for AC operation and a unit construction has been adopted. This firm is also showing *The Wireless World* Straight Six with the Push-Full Quality Amplifier.

## Notes and News

### Strongest Short-wave Station

WHEN the new 100-kilowatt transmitter of the General Electric Co., of Schenectady, has been completed the two short-wave stations, W2XAD and W2XAF, will become the strongest in America and probably in the entire world. The new equipment will increase the signal to more than twice its present strength.

According to Mr. B. W. Bullock, the broadcasting assistant manager of the General Electric Co., of New York, "the previous strength of 18 to 25 kilowatts for W2XAD and W2XAF respectively has rivalled the world's strongest short-wave stations and the greater signal strength should permit world-wide reception throughout the year."

### Radio Relays in Russia

THE system of receiving wireless programmes whereby loud speakers are connected to wires fed by a central receiving set appears to have secured a greater popularity in the U.S.S.R. than in any other country. In Moscow the Central Relay Exchange supplies no fewer than 230,000 subscribers. It is hoped that by the end of the third Five-year Plan this number will have risen to 1,000,000. At present most subscribers have to be content with a choice of only two programmes, but in the case of the remainder special arrangements have been made—presumably by using the wired wireless system—so that they can have a choice of six programmes.

### Cars at Olympia

ADJOINING Olympia, and linked to the Main Hall by a private covered way, Metropolis Garages, Ltd., have opened recently a garage which will prove ideal car-parking facilities for visitors to Radiolympia. There is parking accommodation for 1,200 cars. It is stated that it is possible to empty all floors in under 20 minutes.

The garage is reached by way of the private road leading to Addison Road Station or via Blythe Road.

### Illegal Listening?

A DANISH firm of radio set manufacturers has recently achieved wide publicity as a result of producing a new receiver. The receiver is of the type which *The Wireless World* developed some years ago, and named "Single Span." This receiver, it will be remembered, had a continuous waveband coverage without switching from one waveband to another. In their publicity the Danish firm stressed the point that the design enabled wavelengths to be tuned in which were not available on other sets, and consequently aviation, shipping and military and other official communications could be listened to. In Denmark it is illegal to listen-in to these transmissions, and, of course, listeners in this country also are expressly forbidden to disclose, under the conditions subject to which a broadcast licence is issued, anything other than broadcast transmissions which they may inadvertently come across.

It appears that the matter has started a strong agitation on the part of officialdom in Denmark to get it made illegal for sets to be sold to the public which cover any wavebands other than those expressly allocated to broadcasting.



# Loud Speakers and PA Equipment

**E**XTENSION loud speakers will form an important section of the displays on the stands of British Rola, Celestion and Whiteley Electrical Radio, Ltd., and there have been many interesting developments in the course of the year.

The new Rola F742 PM is a model of particular importance to battery users on

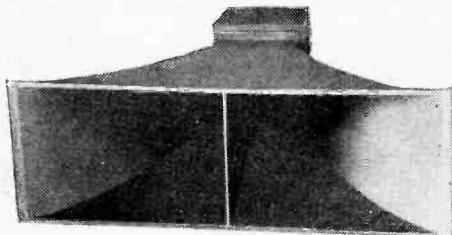

Goodman's duplex horn PA loud speaker.

account of its high sensitivity. A large Alnico magnet supplies the high flux density of 11,500 lines, and great care has been taken to render the unit moisture-proof and suitable for tropical use. The price with transformer is 49s. 6d.

Celestion loud speakers, which are available to the public through Cyril French, of Kingston-on-Thames, cover a wide field of applications and vary in price from the "Standard 6" chassis at 22s. 6d. to the Senior Auditorium AC Model at £22 1s.

Magnavox will again be showing their Duode "33," with its exceptionally wide frequency range, and for those who require a greater power-handling capacity the Model "Sixty-Six." The "2-inch" projection model made by this firm is of special interest to those concerned with public address work.

Extension loud speakers of both chassis and cabinet type, including an elliptical diaphragm type, will be shown by Whiteley Electrical Radio. On this stand will be found an interesting new quality loud speaker, the "Planoflex," in which a small cabinet baffle plays an important part, and also special loud speakers for PA work. A 25-watt AC amplifier and an 8-watt universal model will also be shown.



Reslo 42-inch welded aluminium horn.

The Goodmans Industries exhibit this year will include the new elliptical cone loud speaker and a PA projection horn of the duplex type as well as the 10in. and 12in. high fidelity auditorium loud speakers.

Many specialised applications of PA equipment will be illustrated by the

Tannoy exhibit, which will include a ship's general order and telephone relay system and a high-powered projection loud speaker for naval use. With a flare diameter of only 2ft. this unit has an efficiency of the order of 50 per cent. and will handle 300 watts.

Film industries have made notable additions to their range of horn type loud speakers, and the new LS8 PM unit is designed to handle 35 to 40 watts on the 70-inch horn. New cone loud speakers include the PAC5, with a completely sealed air gap, designed to handle 20 watts.

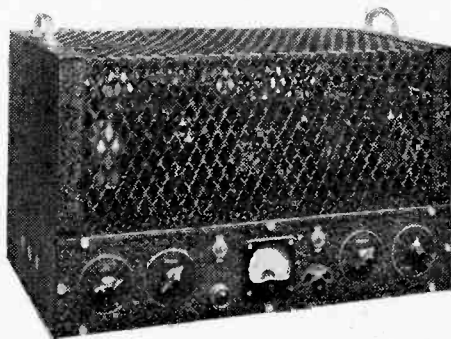

Ardente Model 101 amplifier.



Shaftesbury "Supreme" portable microphone equipment.

In addition to the new microphone, which is dealt with under another heading, Reslo, Ltd., will be showing their SU6 horn unit with Alnico magnet and balsa diaphragm in conjunction with aluminium horns of welded construction.

The Ardente exhibit will include amplifiers of every description, and complete PA equipments, ranging from dance-band microphone outfits to permanent installations for sports grounds, aerodromes and railway stations.

A portable loud speaking outfit for AC/DC operation, which includes a velocity microphone and twin loud speakers, will be one of three outstanding exhibits among the products of Shaftesbury Microphones, Ltd. The other two are an amplifier for AC/DC operation with an AC speech output of 20 watts, and a 64-cycle horn type loud speaker with an 11ft. air column and a flare measuring 6ft. x 2ft.

## Television Programmes

Vision 45 Mc/s. Sound 41.5 Mc/s.

FRIDAY, AUGUST 20th.

3, Sheep Dog Trial—display of canine intelligence in the grounds of Alexandra Palace. 3.15, Gaumont-British News. 3.25, Jack Hylton and his band with soloists. 3.50, Film, "Along Came a Duck."

9, Nancy Logan (songs at the piano). 9.10, British Movietone news. 9.20, Jack Hylton and his band with soloists.

SATURDAY, AUGUST 21st.

3, Nancy Logan. 3.10, Victor Hotchkiss and his Marionettes. 3.20, British Movietone news. 3.30, Variety.

9, The Irish Players in Bernard Duffy's "The Coiner." 9.30, Gaumont-British News. 9.40, "Time to Say Goodbye," a review of farewells.

MONDAY, AUGUST 23rd.

11.30 a.m.-12.30, Special film for demonstration purposes (not for home viewers).

3.0-4.0, Films: "Fire Fighters," "Plane Sailing," "Mad Doctor," News Reel and old-fashioned movie.

9.0-10.0, Films: "The Last of the Clintons" and "Mickey's Orphans."

TUESDAY AUGUST 24th.

11.30 a.m.-12.30, Special film for demonstration purposes.

3.0-4.0, Films: "The Last of the Clintons" and "Touchdown Mickey."

9.0-10.0, Films: "Fire Fighters," "Plane Sailing," "Mad Doctor," News Reel and old-fashioned movie.

WEDNESDAY AUGUST 25th.

For the convenience of visitors to the Radio Exhibition the afternoon and evening television programmes during the show will be divided into three sections with short intervals between them.

11.30 a.m.-12.30, Special film for demonstration purposes.

4, 4.20 and 4.45, Five-minute O.B.s from the Pets' Corner at the Zoological Gardens, Regent's Park. 4.5 and 4.50, Irene Prador in Viennese Songs. 4.10 and 4.55, Walter Gore in Dances.

9.10, British Movietone news. 9.20, Seventy-second edition of "Picture Page." 9.50, Film: "Mad Doctor."

THURSDAY AUGUST 26th.

11.30 a.m.-12.30, Special film for demonstration purposes.

4.0 and 4.45, Exhibition of Horsemanship with descriptive commentaries by Major H. F. Faudel-Phillips from the grounds of Alexandra Palace. 4.5 and 4.50, Bill Baar in American Character Studies. 4.10 and 4.55, Billy Mayerl at the piano. 4.20, O.B. from the Pets' Corner, London Zoo. 4.25, Coffee Stall (No. 3)—a light entertainment.

9.0 and 9.40, Bill Baar. 9.5 and 9.45, Billy Mayerl. 9.10, Gaumont-British News. 9.20, Coffee Stall (No. 3). 9.50, Film: "Mickey's Orphans."

# The Wireless World STRAIGHT

## A Sensitive High-Quality Receiver Designed for Use with a

*FOR general purpose use, and especially for high quality reproduction, the straight set has much to commend it, while its ease of initial adjustment makes it attractive to those who have little testing apparatus available. The receiver described in this article has three RF stages and is both sensitive and selective; it is designed primarily for use with the Push-Pull Quality Amplifier.*

FOR a long time now the superheterodyne has held the field against all rivals, and, except for purely local reception, its supremacy has rarely been challenged. It obtained its original position and has held it so long very largely because of the ease with which extremely high selectivity can be obtained. Selectivity is, in fact, the great virtue of the superheterodyne, but it is not obtained without sacrifice in other directions, and the opinion has recently been growing that it is sometimes too dearly bought.

During the past few months the Correspondence columns of *The Wireless World* have revealed many points in favour of the older straight set, and the article in a recent issue, which summarised the characteristics of both types of receiver, showed that, while the superheterodyne may be capable of greater selectivity, the straight set is completely free from self-generated whistles and is much easier to adjust. The fact that the straight set cannot under normal conditions give as high selectivity as the superheterodyne is not

important if the selectivity can be made high enough to prevent interference in ordinary receiving circumstances. If sufficient selectivity can in reality be obtained with the straight set, then it has much to recommend it.

The selectivity depends upon the number of tuned circuits and their efficiency. More than four circuits cannot normally be employed because gang condensers are not made with more than four sections. The circuits themselves must thus be as efficient as possible and used properly.

The inductance of the coil employed in a tuned circuit is fixed by the tuning range required with a given condenser; the selectivity then depends upon the effective RF resistance when in operation and upon whether it is coupled to another tuned circuit or not. If two or more tuned circuits are coupled together in the manner of a band-pass filter, the selectivity increases as the coupling is loosened, but can never

equal that obtained from the same circuits separated by valves. This assumes, of course, that the valves damp the circuits to a negligible degree.

In practice, this effect is quite marked even when valve damping has some influence, for it is not possible to loosen the coupling of coupled circuits sufficiently without losing out seriously in efficiency. When the coupling is loosened beyond a certain point, at which the selectivity is much lower than when the circuits are separated by valves, the efficiency falls rapidly.

### The Accuracy of Ganging

If we are to obtain the maximum possible selectivity from four tuned circuits, therefore, we must eschew band-pass type circuits and separate all the circuits by valves. This will mean three RF stages, so that it will be easy to secure high amplification. Actually, with efficient coils—and they must be efficient if selectivity is to be good—the full amplification of three stages is unusable, and the gain of each stage must be reduced below its theoretically possible value. This enables the tuned circuits to be loosely coupled to the valves with some further increase in selectivity.

So far, we have assumed that all circuits are tuned exactly to the same fre-

Fig. 1.—The complete circuit diagram of the receiver is shown here. Three RF stages are used with a diode detector and distortionless AVC system; there is one AF stage and a phase-splitter for push-pull.

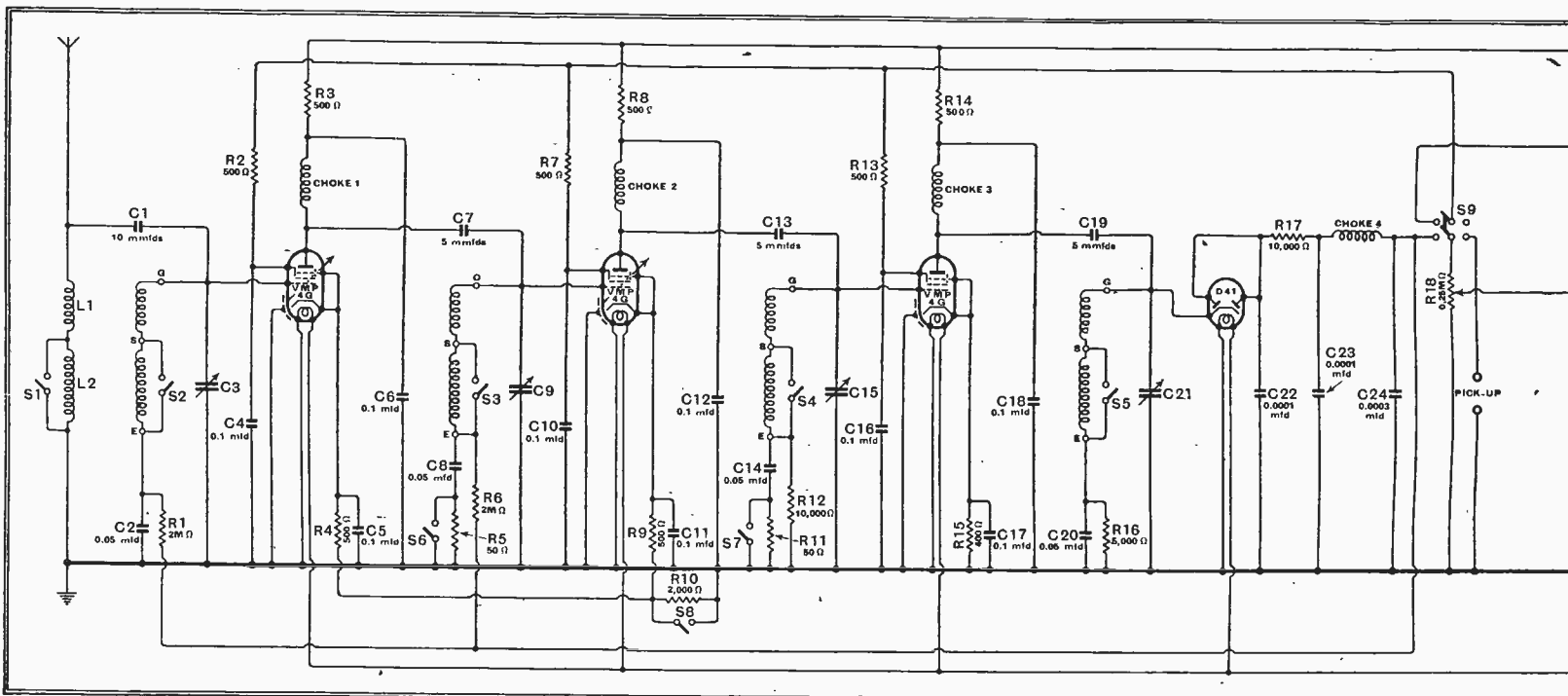

# SIX

## Push-Pull Amplifier

quency. In practice they will not be accurately tuned in resonance with one another at all points within the tuning range, for the ganging can never be quite perfect. Inaccuracies of ganging result in a reduction of both sensitivity and selectivity, and it is obviously of the first importance that such inaccuracies should be reduced as much as possible. In theory, accurate ganging is obtained when the inductances of all coils are the same and the capacities in all circuits are identical. The capacity of a circuit is made up in part by the capacity of the variable condensers and in part by the stray circuit capacity which includes the self-capacity of the coil, the input and output capacities of valves, and the capacity introduced by wiring and switches. The gang condenser is obtained with its sections matched within close limits, and the stray capacities in the different circuits are easily equalised by means of trimmers.

No difficulty arises in connection with intervalve couplings, but in the aerial circuit we must consider the effect of the aerial. The effect of the aerial primary circuit is to alter the inductance of the tuned secondary by an amount which depends upon the degree of coupling and in

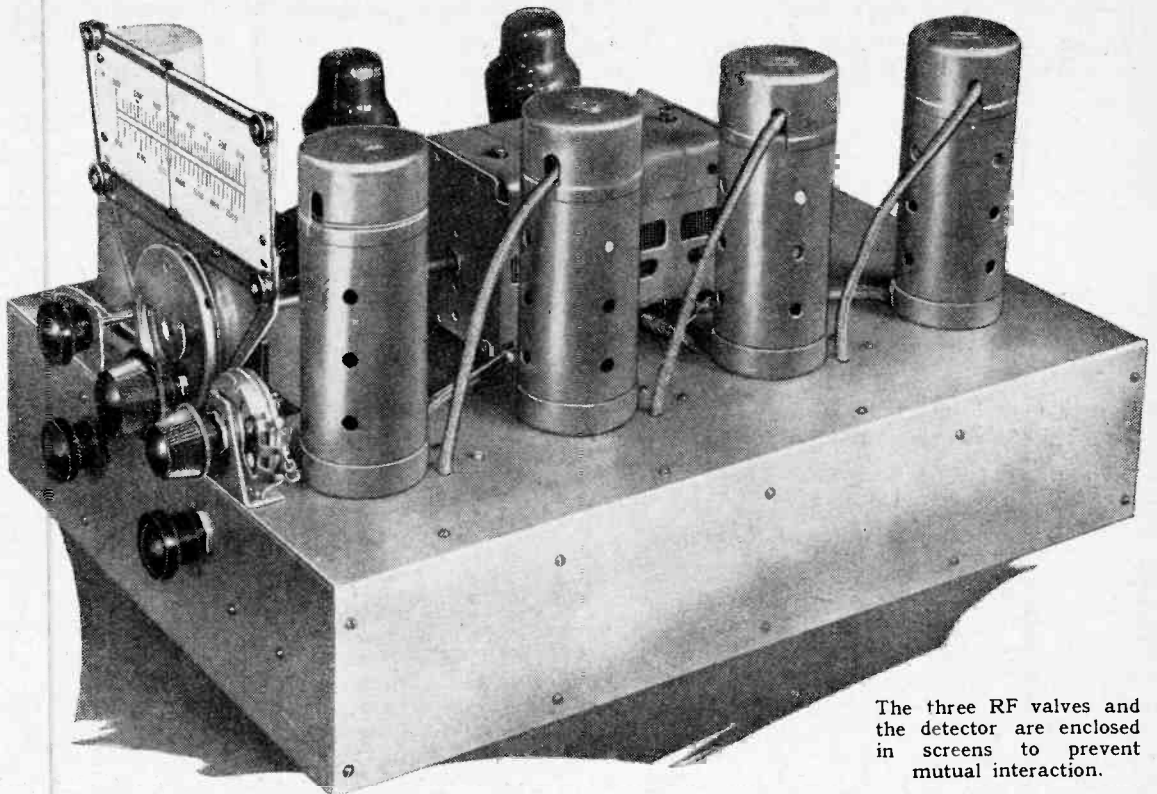

The three RF valves and the detector are enclosed in screens to prevent mutual interaction.

a direction which depends upon the type of coupling. It has been customary in the past to couple the aerial to the tuned circuit either by means of a small primary winding or by joining it to a tapping on the tuning coil. The aerial circuit then resonates at a frequency higher than any within the tuning range, and it can be shown that its effect is to increase the effective inductance of the tuned circuit by an amount which is not constant but which varies with frequency. Correct ganging is then theoretically impossible.

### The Aerial Coupling System

In practice it has been usual to couple the aerial loosely to minimise the ganging errors, but this naturally reduces efficiency. Moreover, both the ganging errors and the type of coupling tend to make the efficiency fall off at low frequencies and the selectivity at high, tendencies which are inherent in all tuned circuits, and which are to be combated in the couplings when possible.

Now, instead of using a small aerial coil, we can use a large one, so that the aerial resonates at a frequency lower than any within the tuning range, and we can couple this coil loosely to the tuned secondary. Under this condition it can be shown that the effect of the aerial is to reduce the secondary inductance by a fixed amount, which depends on the degree of coupling. Accurate ganging is thus theoretically possible, but, since the effect of the aerial is to change the secondary inductance, it must be compensated by an alteration in the inductance, not capacity, of the tuned circuit. An inductance trimmer is thus called for in the ideal state.

All this is only exactly true if the aerial circuit resonates at a much lower frequency than the lowest in the tuning range, and this is not a condition condu-

cive to the maximum efficiency. In practice, the best results are obtained by making the aerial circuit resonate at about 500 kc/s for the medium waveband. The change in secondary inductance is then not quite constant at different frequencies, but varies most at the low frequency end of the range. This is at a point at which any reduction of selectivity can best be tolerated. The general characteristics of this type of coupling are such as to counteract the tendencies of the tuned circuit itself to be more efficient and less selective at high frequencies than low.

The complete circuit diagram of *The Wireless World* Straight Six is shown in Fig. 1, and it will be seen that tuned grid-type inter-valve couplings are employed. An unusual feature is the small capacity of the coupling condensers— $5 \mu\text{F}$  only—which leads to a similar effect to a tapping on the coil for the anode connection. Referring to the first coupling, the anode of the valve is connected to the high potential end of the tuned circuit through the  $5 \mu\text{F}$  condenser  $C_7$ , but it is also connected to earth through a capacity of some  $15 \mu\text{F}$ . This capacity does not appear on the diagram, for it is formed of the output capacity of the valve and all the stray capacities to earth on the anode side of  $C_7$ . The valve anode is thus, in effect, tapped down the tuned circuit.

### The RF Amplifier

The condenser  $C_8$  is included to complete the tuned circuit and enable AVC bias to be applied to the valve; for the same reason  $C_2$  is included in the first circuit. Condensers of the same capacity must be fitted to the other two circuits in order to maintain accurate ganging in spite of their being otherwise unnecessary.

The aerial circuit includes the coils  $L_1$

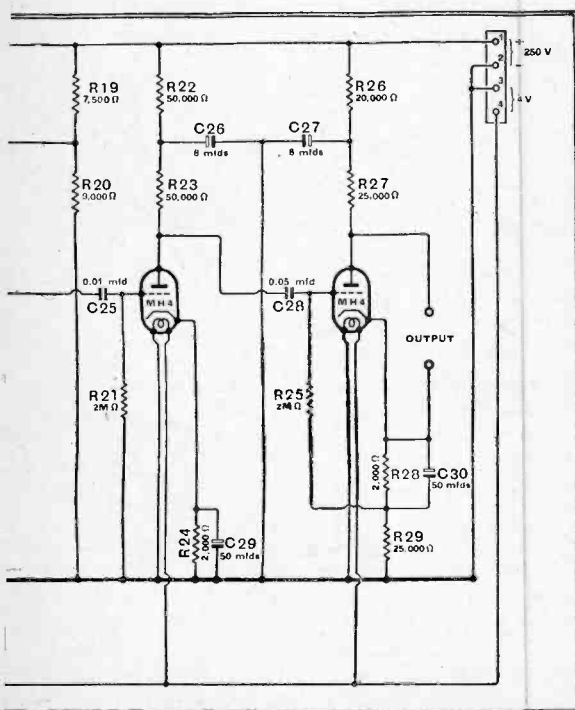

**The Wireless World Straight Six—**

and L2, which resonate with the aerial capacity at a lower frequency than any within the tuning range. Coupling is provided by the 10  $\mu\mu\text{F}$  condenser C1.

All couplings are moderately loose, and the RF valves have a fairly heavy initial bias so that quite a low gain is obtained from each stage. The first and second stages give an amplification of about 12 apiece, while the third stage gives a gain of about 20; the total RF gain thus reaches **n e a r l y 2,500 times — a figure**

control, and its use necessitates the inclusion of a greater amount of AF amplification. It is true that the advantages of delayed AVC can be obtained without

distortion by adopting amplified AVC; all such systems, however, are complicated, and, in view of the performance obtainable with non-delayed AVC, the increase in cost and complexity does not seem justified.

A filter is included in the detector output circuit to keep RF potentials from the AF circuits, and the detector is followed by a triode AF stage which is, in turn, followed by another triode. When the Push-Pull Quality Amplifier is used with the receiver, this valve acts as a phase-splitter. With other amplifiers this stage can either be omitted or converted into an amplifier according to the output required. When R29 is short-circuited, the valve gives good amplification, and a single PX4 or PX25 type valve can be fully loaded with resistance-capacity coupling from its anode circuit; alternatively, such an output stage can be fed with transformer coupling from the anode of the previous AF stage.

The selectivity obtained with the four tuned circuits was found to be so high that a considerable degree of sideband cutting took place. Some form of variable selectivity was felt to be essential, therefore, for the loss of high notes was too great to be readily compensated by tone correction. Variable selectivity is by no means easy to apply to a straight set, for the usual scheme of adopting variably coupled tuned circuits is hardly feasible. In the end the most satisfactory arrangement was found to be to damp two of the circuits heavily for low selectivity.

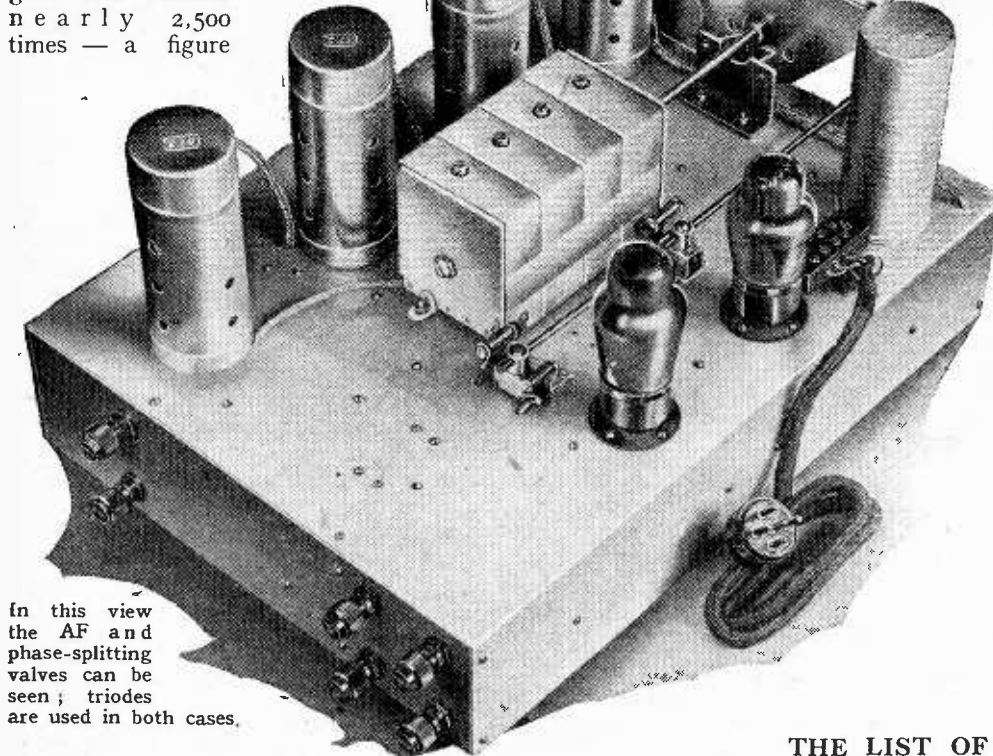

In this view the AF and phase-splitting valves can be seen; triodes are used in both cases.

which is adequate for all normal requirements.

With four tuned circuits connected in this way high selectivity can be obtained provided that the coils are good. Those selected are good-quality types of the iron-cored variety, and have the valuable feature of adjustable inductance. This is variable over a small range by means of a movable iron core, which can be controlled from outside the screening can. This is a valuable feature, since not only does it remove all possibility of ganging errors through discrepancies in coil matching, but it permits correction for the effect of the aerial circuit.

**The Detector and AVC System**

Turning now to the detector, a diode is employed under conditions giving a high degree of linearity. The rectified DC is employed for AVC purposes, and the voltage set up by the passage of the rectified current through the load resistance R18 is applied to the first two RF stages. Non-delayed AVC is used because it is the only simple system which does not introduce distortion. Delayed diode AVC is simple, and possesses good AVC characteristics, but suffers from the disadvantage that it is liable to introduce serious distortion. Non-delayed AVC does not cause distortion, but does not exercise quite such good

**THE LIST OF PARTS REQUIRED**

- |   |  |                               |
|---|--|-------------------------------|
| 1 Variable condenser, 4-gang, C3, C9, C15, C21                                      | 2 2 megohms, $\frac{1}{2}$ watt, R1, R6  | Erie                          |
|   | 1 7,500 ohms, 3 watts, R19   | Claude Lyons                  |
| 1 Dial  | 1 9,000 ohms, 3 watts, R20   | Claude Lyons                  |
| 4 Inductance coils  | 1 Volume control, tapered, 0.25 megohm, R18  | Ferranti "PG"                 |
| 1 Aerial coil, L1, L2,  |  | B.T.S. "ML/FTA"               |
| <b>Condensers:</b>  | 2 Resistance boards, 10-way  | Bulgin C32                    |
| 1 0.01 mfd., tubular, 350 volts DC working, C25                                     | 3 Valve holders, 7-pin (without terminals)   | Clix Chassis Mounting Type V2 |
| 5 0.05 mfd., tubular, 350 volts DC working, C2, C8, C14, C20, C28                   | 3 Valve holders, 5-pin (without terminals)   | Clix Chassis Mounting Type V1 |
| 9 0.1 mfd., tubular, 350 volts DC working, C4, C5, C6, C10, C11, C12, C16, C17, C18 | 4 Valve screens  | B.T.S.                        |
| 2 0.0001 mfd., mica, C22, C23   | 6 Switches, SPST, S1, S2, S3, S4, S5, S7   | Bulgin S80B                   |
| 1 0.0003 mfd., mica, C24  | 1 Switch, S6, S8   | Bulgin S81B                   |
| 3 5 m-mfds., ceramic dielectric $\pm 5\%$ , C7, C13, C19                            | 1 Switch, DPDT, S9   | Bulgin S114                   |
| 1 10 m-mfds., ceramic dielectric $\pm 5\%$ , C1                                     | 3 RF chokes, Ch1, Ch2, Ch3   | Kinva Standard Type           |
| 2 50 mfd. 12 volts, electrolytic, C29, C30  | 1 RF choke, Ch4  | Bulgin HF8                    |
| 1 8-8 mfd. 500 volts peak working, electrolytic, C26, C27                           | 1 Cable, 5-way, with twin 70/36 leads and 5-pin plug   | Goltone                       |
| <b>Resistances:—</b>  | 1 Connector, 4-way   | Bryce 5C2                     |
| 2 50 ohms, $\frac{1}{2}$ watt, R5, R11  | 3 Plug-top valve connectors  | Belling-Lee 1175              |
| 1 400 ohms, $\frac{1}{2}$ watt, R15   | 4 Lengths screened sleeving  | Goltone                       |
| 8 500 ohms, $\frac{1}{2}$ watt, R2, R3, R4, R7, R8, R9, R13, R14                    | 6 Terminals, ebonite shrouded, A, E, PU(2), output (2)   | Belling-Lee "B"               |
| 3 2,000 ohms, $\frac{1}{2}$ watt, R10, R24, R28                                     | 2 Knobs $\frac{1}{2}$ in. bore   | Bulgin K14                    |
| 1 5,000 ohms, $\frac{1}{2}$ watt, R16   | 2 Shaft couplings $\frac{5}{16}$ in. bore  | Bulgin                        |
| 2 10,000 ohms, $\frac{1}{2}$ watt, R12, R17   | 2 Reducing sleeves   | Bulgin                        |
| 1 20,000 ohms, $\frac{1}{2}$ watt, R26  | 1 Length rod 12 in., $\frac{5}{16}$ in. diameter   | Bulgin                        |
| 2 25,000 ohms, $\frac{1}{2}$ watt, R27, R29   | 1 Length rod 17 in., $\frac{3}{16}$ in. diameter   | Bulgin                        |
| 2 50,000 ohms, $\frac{1}{2}$ watt, R22, R23   | Chassis, 16 x 12 x 3 $\frac{1}{4}$ in.   |                               |
| 2 2 megohms, $\frac{1}{2}$ watt, R21, R25   | <b>Miscellaneous:—</b>   | Peto-Scott                    |
|   | 12 lengths systoflex, 4 ozs. No. 20 tinned copper wire, brass, aluminium, etc.   |                               |
|   | Screws: 6 doz. 6BA $\frac{1}{4}$ in. R/hd., 2 doz. 6BA $\frac{3}{16}$ in. R/hd., 1 doz. 1 in. R/hd., 8 doz. 4BA $\frac{3}{16}$ in. R/hd., all with nuts and washers. |                               |
|   | <b>Valves:—</b>  |                               |
|   | 3 VMP4G metallised; 1 D41 non-metallised; 2 MH4 non-metallised   | Osram                         |



**The Wireless World Straight Six—**

Accordingly, 50-ohm resistances R5 and R11 are included in the second and third tuned circuits. These are short-circuited by means of the switches S6 and S7 when full selectivity is needed.

The inclusion of these resistances not only reduces the selectivity but the sensitivity also. Another switch, S8, consequently short-circuits a portion of the bias resistance of the first two valves when the damping resistances are in circuit, and so reduces the magnitude of the change in sensitivity.

This simple scheme has been found in practice to be very satisfactory, and the two degrees of selectivity meet most normal requirements.

*The full construction of the receiver will be dealt with in next week's issue. A large wiring diagram and notes on the operation will also be given.*

**OLYMPIA SHOW  
TWO MORE  
SPECIAL NUMBERS  
AUG. 27th  
COMPLETE SHOW REPORT.  
A stand-to-stand review which will serve as a useful guide to the Exhibits to be found in this year's Show.  
SEPT. 3rd  
OLYMPIA REVIEW.  
Fully illustrated reports by *The Wireless World* technical staff on new developments and general trend of progress revealed by a careful survey of all that was to be seen at the Exhibition.**

# 30-Watt PA Amplifier

**High-quality Equipment  
with Mixer and Tone  
Control**

TO BE FULLY DESCRIBED IN A  
FORTHCOMING ISSUE

**P**UBLIC address work demands not only a large undistorted output but a good system of tone-control and the ability to mix inputs from pick-up and microphone. In *The Wireless World* 30-watt Amplifier an output of 28 watts is secured from a pair of pentodes in push-pull with a very low degree of distortion. Owing to the use of negative feed-back amplitude distortion is at a minimum and the frequency response is flat within  $\pm 0.8$  db. over the extremely wide range of 20 c/s to 20,000 c/s; last, but by no means least, the output impedance is low so that the speaker is properly damped.

- LIST OF PARTS.  
AMPLIFIER UNIT.**
- 1 Mains transformer with connecting block. Primary: 200-250 volts, 50 c/s. Secondaries: 450-0-450 volts, 180 mA.; 4 volts, 4 amps., CT; 4 volts, 8-9 amps. CT  
**Savage T18581**
  - 1 Output transformer, 1-4-9 and 16 ohms  
**Sound Sales 428/30G**
  - 1 Smoothing Choke, 25H., 180 mA.  
**Vortexion CH25**
  - 1 Input transformer, push-pull, ratio 1:3.5  
**Ferranti AF5c**
  - 4 Valve holders, 5-pin, without terminals  
**Clix Chassis Mounting Standard Type V1**
  - 2 Valve holders, 7-pin, without terminals  
**Clix Chassis Mounting Standard Type V2**
  - 1 Twin safety fuse-holder with 5 amp. fuses  
**Belling-Lee 1033**
  - 3 Terminals, ebonite shrouded, Input, LS+, LS-  
**Belling-Lee "B"**

The mixer unit shown coupled to the amplifier.

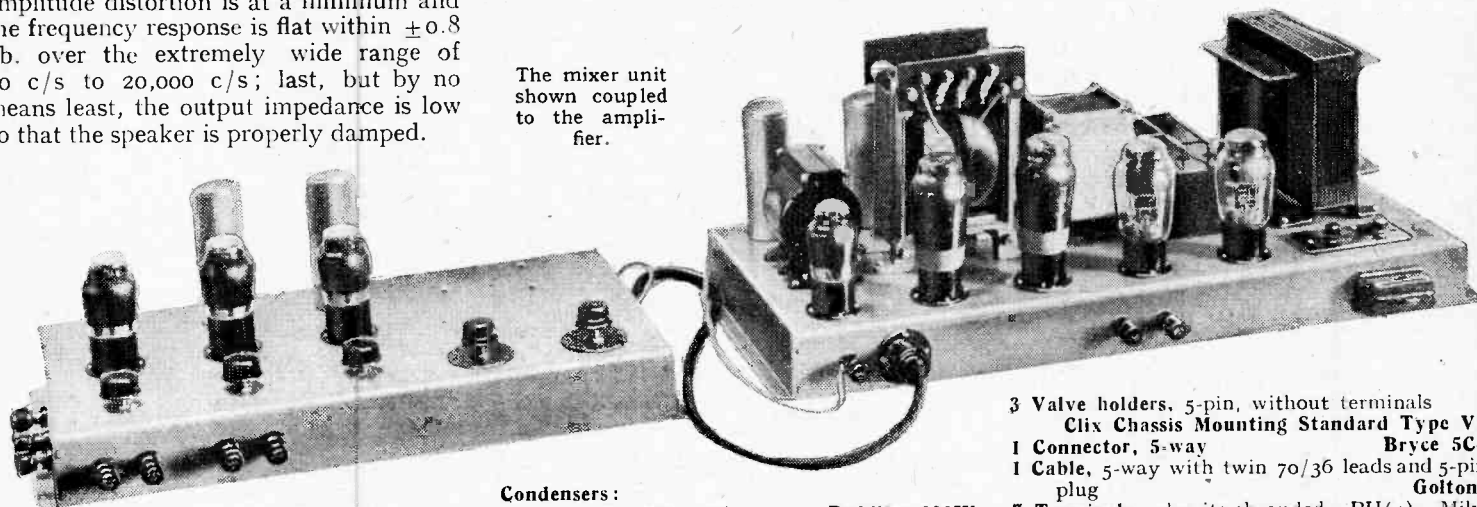

A system of tone-control permitting the bass and treble response to be independently increased or decreased is included and enables no fewer than twenty-five different frequency characteristics to be secured. A scientifically designed mixing system enables two inputs to be mixed and independently controlled.

- Condensers:**
- 1 0.005 mfd., mica **Dubilier 690W**
  - 1 50 mfd., 12 volts, electrolytic **T.C.C. "FT"**
  - 1 25 mfd., 25 volts, electrolytic **T.C.C. "FT"**
  - 1 8 mfd., 500 volts, electrolytic **T.C.C. 805**
  - 2 8 mfd., 440 volts, electrolytic **T.C.C. 802**
  - 2 4 mfd., 650 volts DC working **Dubilier Type LEG**

- Resistances:**
- 1 200 ohms,  $\frac{1}{2}$  watt **Dubilier F $\frac{1}{2}$**
  - 1 500 ohms,  $\frac{1}{2}$  watt **Dubilier F $\frac{1}{2}$**
  - 1 1,500 ohms,  $\frac{1}{2}$  watt **Dubilier F $\frac{1}{2}$**
  - 2 5,000 ohms,  $\frac{1}{2}$  watt **Dubilier F $\frac{1}{2}$**
  - 2 70,000 ohms,  $\frac{1}{2}$  watt **Dubilier F $\frac{1}{2}$**
  - 1 1 megohm,  $\frac{1}{2}$  watt **Dubilier F $\frac{1}{2}$**
  - 1 20,000 ohms, 1 watt **Dubilier F1**
  - 1 165 ohms **Dubilier "Spirohm"**
  - 1 2,200 ohms, 20 watts **Bulgin PR8A**
  - 1 7,200 ohms, 40 watts **Bulgin PR36A**
- Chassis, 24 X 10 X 2 in. **Sound Sales****
- Miscellaneous: **Peto-Scott****
- 3 lengths systoflex, small quantity Nos.
  - 16 and 18 tinned copper wire, etc. Screws: 30  $\frac{1}{16}$  in. 6BA R/hd., 6  $\frac{3}{16}$  in. 6BA R/hd., 26  $\frac{1}{8}$  in. 4BA R/hd., all with nuts and washers.
- Valves:**
- 1 244v. met., 2 Pen.428, 2 IW4 **Mullard**

**MIXER UNIT**

- 1 Choke, 0.54H., tapped at 0.18H. **B.T.S. WW1**
- 2 Switches, double-pole, 5-way, with knobs **B.T.S. C125**

**Condensers:**

- 1 0.0015 mfd., tubular, 450 volts DC working **T.C.C. 300**
- 1 0.015 mfd., tubular, 450 volts DC working **T.C.C. 300**
- 1 0.001 mfd., tubular, 450 volts DC working **T.C.C. 300**
- 1 0.05 mfd., tubular, 350 volts DC working **T.C.C. 250**
- 2 0.1 mfd., tubular, 350 volts DC working **T.C.C. 250**
- 1 0.25 mfd., tubular, 350 volts DC working **T.C.C. 250**
- 1 0.5 mfd., tubular, 350 volts DC working **T.C.C. 250**
- 2 8 mfd., 440 volts, electrolytic **T.C.C. 802**
- 3 50 mfd., 12 volts, electrolytic **T.C.C. FT**

**Resistances:**

- 1 1,000 ohms,  $\frac{1}{2}$  watt **Dubilier F $\frac{1}{2}$**
- 2 2,000 ohms,  $\frac{1}{2}$  watt **Dubilier F $\frac{1}{2}$**
- 1 3,000 ohms,  $\frac{1}{2}$  watt **Dubilier F $\frac{1}{2}$**
- 1 10,000 ohms,  $\frac{1}{2}$  watt **Dubilier F $\frac{1}{2}$**
- 2 20,000 ohms,  $\frac{1}{2}$  watt **Dubilier F $\frac{1}{2}$**
- 1 40,000 ohms,  $\frac{1}{2}$  watt **Dubilier F $\frac{1}{2}$**
- 2 50,000 ohms,  $\frac{1}{2}$  watt **Dubilier F $\frac{1}{2}$**
- 1 100,000 ohms,  $\frac{1}{2}$  watt **Dubilier F $\frac{1}{2}$**
- 2 Potentiometers, tapered, 0.25 megohm **Dubilier "B"**
- 1 Fader, 0.25+0.25 megohm **Dubilier "Fadover"**

- 3 Valve holders, 5-pin, without terminals **Clix Chassis Mounting Standard Type V1**
  - 1 Connector, 5-way **Bryce 5C4**
  - 1 Cable, 5-way with twin 70/36 leads and 5-pin plug **Goltone**
  - 7 Terminals, ebonite-shrouded, PU(4), Mike (2), E **Belling-Lee "B"**
  - 1 Length screened sleeving **Goltone**
  - Chassis, 19 X 9 X 2 in. **Sound Sales**
- Miscellaneous: **Peto-Scott****
- 4 lengths systoflex, small quantity No. 18 tinned copper wire, etc. Screws: 12  $\frac{1}{16}$  in. 6BA R/hd., 2  $\frac{1}{8}$  in. 6BA R/hd., 2  $\frac{3}{16}$  in. 4BA R/hd., all with nuts and washers.
- Valves:**
- 3 354v. plain **Mullard**

# Television Receivers and Cathode-ray Gear

## PROGRESS IN RADIO'S NEWEST BRANCHES

FOR a year now television has been out of the experimental stage and quite a number of receivers will be found on the stands, apart from those operating in the demonstration booths.

The H.M.V. receivers are substantially unchanged and include a vision receiver of the straight type with six RF stages preceding a diode detector which feeds the picture signal to the tube directly. There are eight tuned circuits and they are all pre-tuned. The output of the detector is also fed to the sync separator in which two RF pentodes and a diode are employed. Electromagnetic deflection is used and there are two two-valve time-bases; each of these consists of an RF pentode saw-tooth oscillator and a pentode amplifier.

The picture size is 10in. by 8in. and indirect viewing is adopted, the tube being mounted vertically and viewed through a surface-silvered mirror carried by the lid of the cabinet.

The different models vary in the cabinet work and in the type of sound equipment included. The model 900 has an ultra-short-wave sound receiver only; this is a four-valve superheterodyne. The model 901, however, has an all-wave receiver so that its operation is not confined to television reception, but it can also be used for general broadcasting. The model 902 is similar but is a radio-gramophone with an automatic record changer. These sets are priced respectively at 60 guineas, 80 guineas and 120 guineas. The apparatus shown by Marconiphone is very similar electrically but differs somewhat in the mechanical features.

The Haynes Radio Viceiver is a superheterodyne and the vision and sound

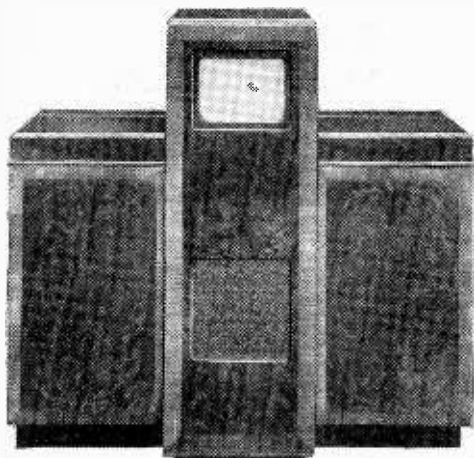

The Haynes Radio Viceiver television equipment.

equipment is entirely separate, no parts being common. The vision receiver has one RF stage and a triode-hexode frequency-changer; this is followed by four IF valves coupled by double-tuned circuits of the band-pass type and employing valves of high mutual conductance. The

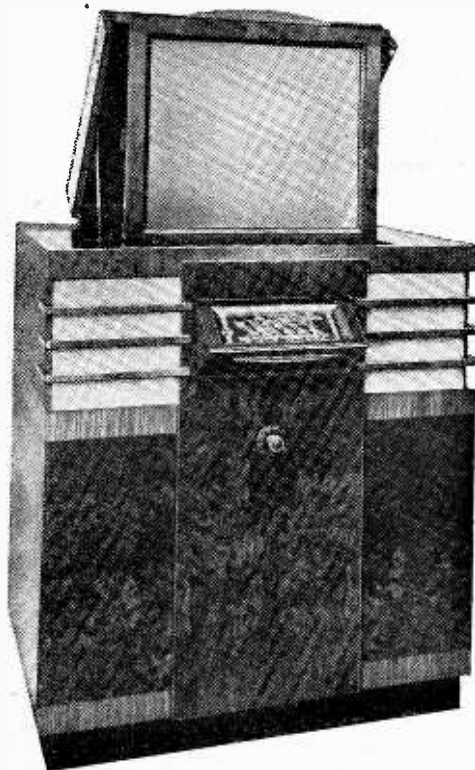

The Philips projection television receiver.

detector is of the push-pull type with two low-resistance diodes and feeds into a pentode vision-frequency amplifier. This is followed by a diode DC restorer and the signal is then passed to the CR tube and to the tetrode sync separator.

A 12in. magnetically deflected tube is used and each time-base includes two valves—a gas-filled triode saw-tooth oscillator and a power tetrode amplifier. Separate mains equipment is provided for the receiver and time-base, and the tube naturally has its own high voltage supply.

One of this firm's standard sound receivers is included with either a 6-watt or a 14-watt amplifier and the complete apparatus with the smaller amplifier cost 120 guineas.

The Baird receiver is a superheterodyne and it employs a 15-in. tube. Magnetic deflection is used and focusing is also effected magnetically. Cossor, however,

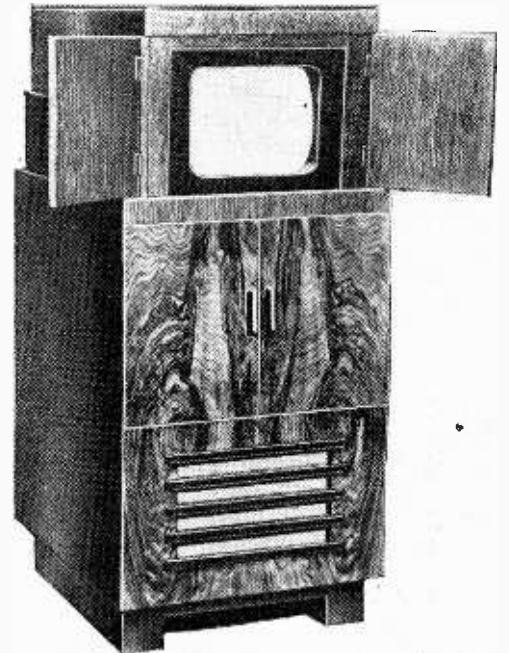

The Cossor television receiver, Model 137T.

although employing a superheterodyne type of receiver, which is designed for single sideband reception, adopt electrostatic deflection and focusing. Ferranti also adhere to the superheterodyne principle, but are "all-magnetic" for deflection and focusing. Hard-valve time-bases are used.

Although television has not been long enough with us for receivers to become at all standardised in design, yet there is some uniformity in that hitherto the picture has been viewed directly, or through a mirror, on the end of the tube. This is not the case in the Philips receiver, however, for in this the picture is projected on to an etched glass screen 20in. by 16in. in size.

The tube is mounted vertically and has a diameter of four inches. The picture, about 2in. in size, appears on the fluorescent screen of the tube and is projected through a lens system and inclined mirror on to the viewing screen. Owing to the small picture on the tube the spot size must be extremely small and it actually has a diameter of the order of one-tenthousandth of an inch. In order to obtain this small diameter with the necessary brilliancy the tube is operated at 25,000 volts. For safety, all high voltage parts are enclosed in a steel container; opening the door of this operates a safety switch which disconnects the mains and earths the high-voltage terminal so that there is no possibility of shock. Two rectifiers are used in the voltage-doubler circuit to produce this high voltage.

The receiver is a superheterodyne commencing with one RF stage which feeds into two triode-hexode frequency-changers, one for vision and the other for sound. The grid circuits of these valves

**Television Receivers and Cathode-ray Gear**

are common, but the anode circuits feed the vision and sound IF amplifiers. The vision amplifier contains four IF stages and the path of the signal is then split again, for the signal feeds a diode detector and also a fifth IF amplifier. The output of the detector is taken to a pentode vision-frequency stage and thence to the CR tube for modulation.

The output of the fifth IF valve feeds a duo-diode sync-separator, the output of which in turn goes to the time-base. Here a gas-filled triode is used for the frame saw-tooth oscillator in conjunction with a pentode amplifier. The line oscillator is a back-coupled pentode with an amplifier consisting of two large power pentodes in parallel. Magnetic deflection is adopted for both line and frame scanning and magnetic focusing is also used.

The output of the sound-frequency changer is taken to a single IF stage and thence to a duo-diode detector which feeds into the pick-up terminals of a standard broadcast receiver (actually the model 785) included in the same cabinet. The sound equipment thus provides reception on broadcast wavelengths as well as on television. The apparatus is listed at 165 guineas.

Ultra Electric have three television receivers, the T20 for sound and vision reception only, and the T30 AW and T40 AW covering the normal broadcast bands and 16.8-50 metres in addition. The first two are fitted with a small CR tube giving a picture of some 7½ in. × 6½ in., but the last has a large tube and a picture size of 10 in. × 8 in.

The apparatus commences with an RF stage, and then there is a triode-hexode frequency-changer followed by two IF stages, after which the path of the signal is split. The sound signal is picked

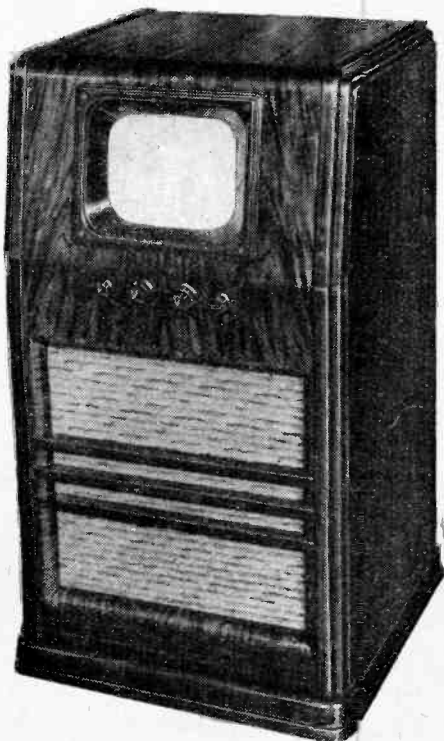

The Ultra model T20 television receiver.

out and passed through another IF stage at 2.6 Mc/s, and thence to a duo-diode output pentode. The vision signal also goes through another IF valve, the frequency being 6.1 Mc/s, which feeds a low-capacity diode detector. Single-sideband reception is adopted. This valve is fol-

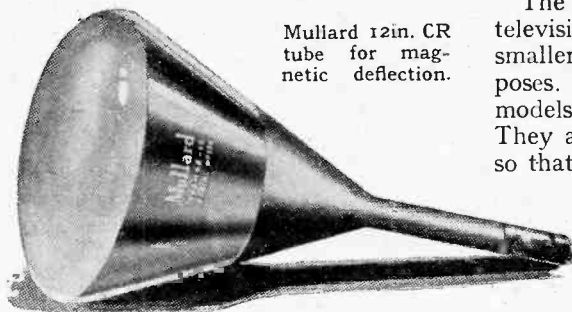

Mullard 12in. CR tube for magnetic deflection.

lowed by a vision-frequency amplifier having a response characteristic which is substantially flat up to 2.25 Mc/s.

Magnetic deflection and focusing are used and the time-bases include power pentodes in their output circuits.

A home-construction television chassis is being shown by British Television Supplies. This is a superheterodyne with one RF stage and a triode-hexode frequency-changer; there are three IF stages, the last being push-pull, and a diode detector feeding into a vision-frequency amplifier. Gas-filled triodes are used in the time-base with balanced amplifiers. A 12in. tube is employed with electrostatic deflection and focusing.

**Cathode-ray Equipment**

Apart from receivers, cathode-ray tubes intended for television purposes are well represented in the exhibition. Many of the newer models are designed for magnetic deflection and focusing, and Ediswan now have two of this pattern. The 9 MH and 12 MH have 9in. and 12in. diameter screens respectively, and are fitted with the standard 7-pin base. The screens are white and the heaters consume 1.5 amp. at 2 volts. Both tubes are rated for a maximum anode supply of 6,000 volts, but the smaller one is normally operated at 4,500 volts and the larger at 5,000 volts. Some 30-60 volts negative grid bias is necessary.

Mullard also have two new tubes for magnetic deflection and focusing; in spite of their use of magnetic focusing, however, the tubes have two anodes. The M46-12 has a 12in. screen and the M46-15 a 15in. screen, but their ratings are the same. The heaters take 1.2 amp. at 4 volts, and the second anode should be supplied at 4,000-5,000 volts; the first anode needs only 250 volts and grid bias is 0-60 volts. The focusing coil requires 500 amp-turns. The tubes have standard 4-pin bases with the second anode brought out to a side terminal.

The Cossor tubes are of the electrostatic type and the 3272 is the television model. It has a directly-heated cathode operating at 0.6 volt, and requires first, second and third anode voltages of 250, 700 and 4,000

volts respectively with a grid bias of some 250 volts.

The Baird tube is all magnetic and has a 1.7-volt heater. Up to 6,500 volts can be applied to the anode and 110 volts grid bias is needed. The screen is white and has a diameter of 15in.

The subject of cathode-ray tubes for television leads on naturally to that of the smaller tubes used for oscilloscope purposes. Cossor have some high vacuum models with a screen diameter of 1½ in. They are used in groups of two or three so that several phenomena can be photographed simultaneously. This firm has also a wide range of gas-focused and high-vacuum oscillograph tubes which are obtainable in a wide variety of screen materials. The Mullard and Ediswan tubes are all of the high-vacuum type; some are quite small, notably the Mullard E40-G3, which has a 2½ in. screen. The Mullard A41-G4 has a 4in. screen, and the plates nearest the screen are so designed that an unbalanced

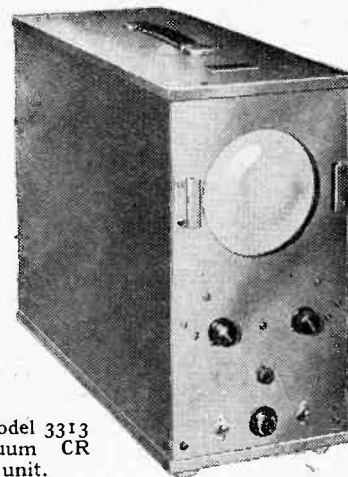

Cossor Model 3313 high-vacuum CR tube unit.

input can be used without distortion of the image—a great convenience.

One of the most versatile pieces of apparatus embodying these smaller tubes is the Cossor 3332 oscilloscope. It includes a 4½ in. gas-focused tube having split plates for the avoidance of origin distortion. The time-base is of the gas-triode type and operates up to 50 kc/s. An amplifier is included and the tube is fitted

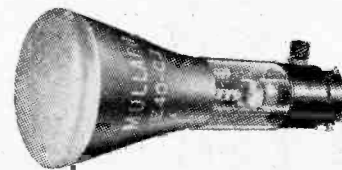

The Mullard E40-G3 oscillograph tube.

with deflection coils for current measurements. It is entirely mains operated, and the tube has a mu-metal screen.

For use at higher frequencies there is a high-vacuum tube unit Model 3313. This does not include a time-base, but has a special beam trigger circuit so that the electron beam can be turned on or off very suddenly to facilitate recording.

# GUIDE TO STANDS AND EXHIBITORS AT OLYMPIA

## Alphabetical List with Stand Numbers and References to the Plans

Name.	Stand.	Reference.	Name.	Stand.	Reference.
Ace Radio .. .. .	103	B 4	Halcyon Radio, Ltd. .. .. .	35	D 2
Aerialite, Ltd. .. .. .	28	D 3	Harries Thermionics, Ltd. .. .. .	3	D 4
Aerodyne Radio, Ltd. .. .. .	52	C 1	Harris & Russell, Ltd. .. .. .	T. 12	E 1
All Power Transformers, Ltd. .. .. .	209	H 4	Haynes Radio, Ltd. .. .. .	11	D 3
Ardente Acoustic Laboratories .. .. .	2	C 4	Heayberd, F. C., & Co. .. .. .	25	D 2
Armstrong Manufacturing Co. .. .. .	220	E 4	Henley's, W. T., Telegraph Works Co., Ltd. .. .. .	20	D 1
Assurance Finance Trust, Ltd. .. .. .	219	E 4	High Vacuum Valve Co., Ltd. .. .. .	27	D 3
Automatic Coil Winder & Elec. Equip. Co., Ltd. 30 & 166	D 4 & H 3		Hobday Bros., Ltd. .. .. .	T. 10	E 1
			Houghtons (Ensign, Ltd.) .. .. .	T. 19	G 1
			Hunt, A. H., Ltd. .. .. .	155	H 2
<b>Baird Television, Ltd.</b> .. .. .	87	A 4			
Balcombe, A. J., Ltd. .. .. .	55	C 3	<b>Iliffe &amp; Sons, Ltd.</b> .. .. .	7	D 3
Barratt & Robinson, Ltd. .. .. .	201	H 4	Invicta Radio, Ltd. .. .. .	56	D 3
Beethoven Radio, Ltd. .. .. .	34	D 3			
Belling & Lee, Ltd. .. .. .	42	B 1	<b>Jackson Bros. (London), Ltd.</b> .. .. .	93	A 1
Benjamin Electric, Ltd. .. .. .	17	D 1			
Bifurcated & Tubular Rivet Co., Ltd. .. .. .	151	H 1	<b>Kolster-Brandes, Ltd.</b> .. .. .	65	B 1
Bowmaker, Ltd. .. .. .	217	F 4			
Bridger, R. O., & Co., Ltd. .. .. .	150	H 1	<b>L.E.S. Distributors, Ltd.</b> .. .. .	T. 6	E 2
Britannia Batteries, Ltd. .. .. .	83	A 2	Lissen, Ltd. .. .. .	73	B 3
British Belmont Radio, Ltd. .. .. .	79	A 1	Lugton & Co., Ltd. .. .. .	T. 15	F 1
British Broadcasting Corporation .. .. .	51 & 78	C 1 & B 1			
British G.W.Z. Battery Co., Ltd. .. .. .	82	A 2	<b>McMichael Radio, Ltd.</b> .. .. .	59	C 4
British Mechanical Productions, Ltd. .. .. .	94	A 1	Manufacturers Accessories Co. (1928), Ltd. .. .. .	T. 4	E 3
British Metal Engraving Co., Ltd. .. .. .	158	H 1	Marconiphone Co., Ltd. .. .. .	53 & 64	C 2 & C 1
British Pix Co., Ltd. .. .. .	211	G 4	May & Baker, Ltd. .. .. .	157	H 2
British Rola Co., Ltd. .. .. .	41	B 1	Mercantile Credit Co., Ltd. .. .. .	215	F 4
British Television Supplies, Ltd. .. .. .	47	B 1	Mica & Micanite Supplies, Ltd. .. .. .	154	H 2
British Tungram Radio Works, Ltd. .. .. .	36	D 2	Milnes Radio Co., Ltd. .. .. .	88	A 3
British Wireless for the Blind Fund .. .. .	46	B 1	Mullard Wireless Service Co., Ltd. .. .. .	72 & 161	B 4 & H 3
Brown Bros., Ltd. .. .. .	T. 18	G 1			
Bulgin, A. F., & Co., Ltd. .. .. .	1	C 4	<b>New London Electron Works, Ltd.</b> .. .. .	80	A 2
Burndep, Ltd. .. .. .	85	A 3	Newnes, Geo., Ltd. .. .. .	10	D 3
Bush Radio, Ltd. .. .. .	70	B 4			
			<b>Odhams Press, Ltd.</b> .. .. .	T. 2	E 3
<b>Cadisch, R., &amp; Sons</b> .. .. .	T. 9	E 2	Olds Discount Co., Ltd. .. .. .	218	F 4
Celestion, Ltd. .. .. .	26	D 3			
Chloride Electrical Storage Co., Ltd. .. .. .	32	D 4	<b>Partridge, Wilson &amp; Co., Ltd.</b> .. .. .	29	D 4
Cole, E. K., Ltd. .. .. .	69	B 3	Philips Lamps, Ltd. .. .. .	68	B 3
Collaro, Ltd. .. .. .	101	A 2			
Cosmocord, Ltd. .. .. .	48	C 1			
Cossor, A. C., Ltd. .. .. .	61 & 163	C 3 & H 3			
Crypton Equipment, Ltd. .. .. .	202	H 4			
<b>Davies, D. M. (Slough), Ltd.</b> .. .. .	16	D 1			
Davis & Timmins, Ltd. .. .. .	213	F 4			
Decca Gramophone Co., Ltd. .. .. .	71	B 4			
De La Rue, Thos., & Co., Ltd. .. .. .	6	D 4			
Department of Overseas Trade .. .. .	49	C 1			
Dew, A. J., & Co., Ltd. .. .. .	T. 20	G 1			
Dibben, Horace, Ltd. .. .. .	T. 8	E 2			
Dubilier Condenser Co. (1925), Ltd. .. .. .	81	A 2			
Dynaport Radio & Television, Ltd. .. .. .	18	D 1			
Dynatron Radio, Ltd. .. .. .	104	B 4			
Dyson, J., & Co., Ltd. .. .. .	T. 14	F 1			
<b>Eastick, J. J., &amp; Sons</b> .. .. .	T. 3	E 3			
East London Rubber Co., Ltd. .. .. .	T. 16	F 1			
Eavestaff, W. G., & Sons, Ltd. .. .. .	204	H 3			
Edison Swan Electric Co., Ltd. .. .. .	57	C 4			
Elf, Gordon, Ltd. .. .. .	95	A 1			
Everett, Edgcombe & Co., Ltd. .. .. .	164	H 3			
Ever Ready Co. (G.B.), Ltd. .. .. .	58	C 4			
<b>Ferranti, Ltd.</b> .. .. .	21 & 74	D 1 & B 3			
Film Industries, Ltd. .. .. .	4	D 4			
Flinders (Wholesale), Ltd. .. .. .	T. 7	E 2			
Fuller Accumulator Co. (1926), Ltd. .. .. .	100	A 2			
<b>Gambrell Electrical Equipment Co., Ltd.</b> .. .. .	14	D 1			
Garrard Eng. & Mfg. Co., Ltd. .. .. .	37	D 1			
General Electric Co., Ltd. .. .. .	54 & 62	C 2			
Gilbert, C., & Co., Ltd. .. .. .	T. 17	G 1			
Goodmans Industries, Ltd. .. .. .	43	B 1			
Gramophone Co., Ltd. (H.M.V.) .. .. .	66 & 76	B 2			

### TELEVISION DEMONSTRATION ROOMS IN THE NATIONAL HALL (All prefaced TT)

- |  |                               |
|--|-------------------------------|
| 1 Radio Gramophone Development Co., Ltd. | 8 Baird Television, Ltd.      |
| 2 Cossor, A. C., Ltd.                    | 9 Ferranti, Ltd.              |
| 3 Cole, E. K., Ltd.                      | 10 General Electric Co., Ltd. |
| 4 Phillips Lamps, Ltd.                   | 11 Kolster-Brandes, Ltd.      |
| 5 Marconiphone Co., Ltd.                 | 12 Ultra Electric, Ltd.       |
| 6 Pye, Ltd.                              | 13 Halcyon Radio, Ltd.        |
| 7 Edison Swan Electric Co., Ltd.         | 14 Gramophone Co., Ltd.       |

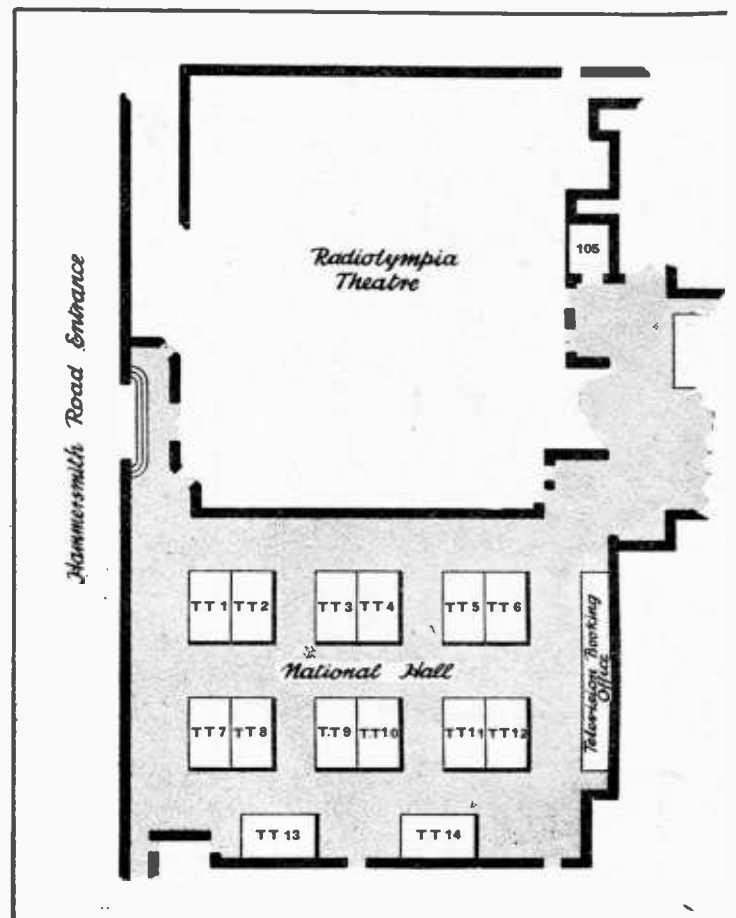



Name.	Stand.	Reference.
Pilot Radio, Ltd.	84	A 3
Plessey Co., Ltd.	22	D 2
Pye, Ltd.	60	C 3
<b>Radio Gramophone Development Co., Ltd.</b>	67	<b>B 2</b>
Radiometers, Ltd.	162	<b>H 3</b>
Radio Society of Gt. Britain	214	<b>F 4</b>
Rawplug Co., Ltd.	91	<b>A 2</b>
Regentone Products, Ltd.	97	<b>A 1</b>
Reslo (Sound Equipment), Ltd.	24	<b>D 2</b>
Rist's Wires & Cables, Ltd.	159	<b>H 1</b>
Rose, Norman (Electrical), Ltd.	207	<b>H 4</b>

Name.	Stand.	Reference.
<b>Salford Electrical Instruments, Ltd.</b>	168	<b>H 2</b>
Scott Insulated Wire Co., Ltd.	156	<b>H 2</b>
Selecta Gramophones, Ltd.	T. 13	<b>F 1</b>
Shaftesbury Microphones, Ltd.	92	<b>A 2</b>
Siemens Electric Lamps & Supplies, Ltd.	31	<b>D 4</b>
Sound Sales, Ltd.	89	<b>A 2</b>
Steatite & Porcelain Products, Ltd.	152	<b>H 2</b>
Sterling Batteries, Ltd.	5	<b>D 4</b>
Stratton & Co., Ltd.	23	<b>D 2</b>
<b>Tannoy Products</b>	86	<b>A 4</b>
Telegraph Condenser Co., Ltd.	38	<b>C 1</b>
Telsen Electric Co. (1935), Ltd.	90	<b>A 2</b>
Texaloom Radio, Ltd.	15	<b>D 1</b>
The 362 Radio Valve Co., Ltd.	210	<b>H 4</b>
Thompson, Diamond & Butcher	T. 5	<b>E 2</b>
Tucker Eyelet Co., Geo., Ltd.	102	<b>A 3</b>
<b>Ultra Electric, Ltd.</b>	63	<b>C 2</b>
<b>Varley</b>	99	<b>A 2</b>
Vidor, Ltd.	33	<b>D 3</b>
<b>Webber, J. M., &amp; Co., Ltd.</b>	T. 11	<b>E 1</b>
Westinghouse Brake & Signal Co., Ltd.	77	<b>B 1</b>
Weston Electrical Instrument Co., Ltd.	167	<b>H 3</b>
Whiteley Electrical Radio Co., Ltd.	75	<b>B 2</b>
Wingrove & Rogers, Ltd.	44	<b>A 1</b>
"Wireless & Electrical Trader"	T. 1	<b>E 4</b>
Wireless Retailers' Association	203	<b>H 4</b>
<b>Wireless World</b>	7	<b>D 3</b>
Wright & Weaire, Ltd.	165	<b>H 3</b>

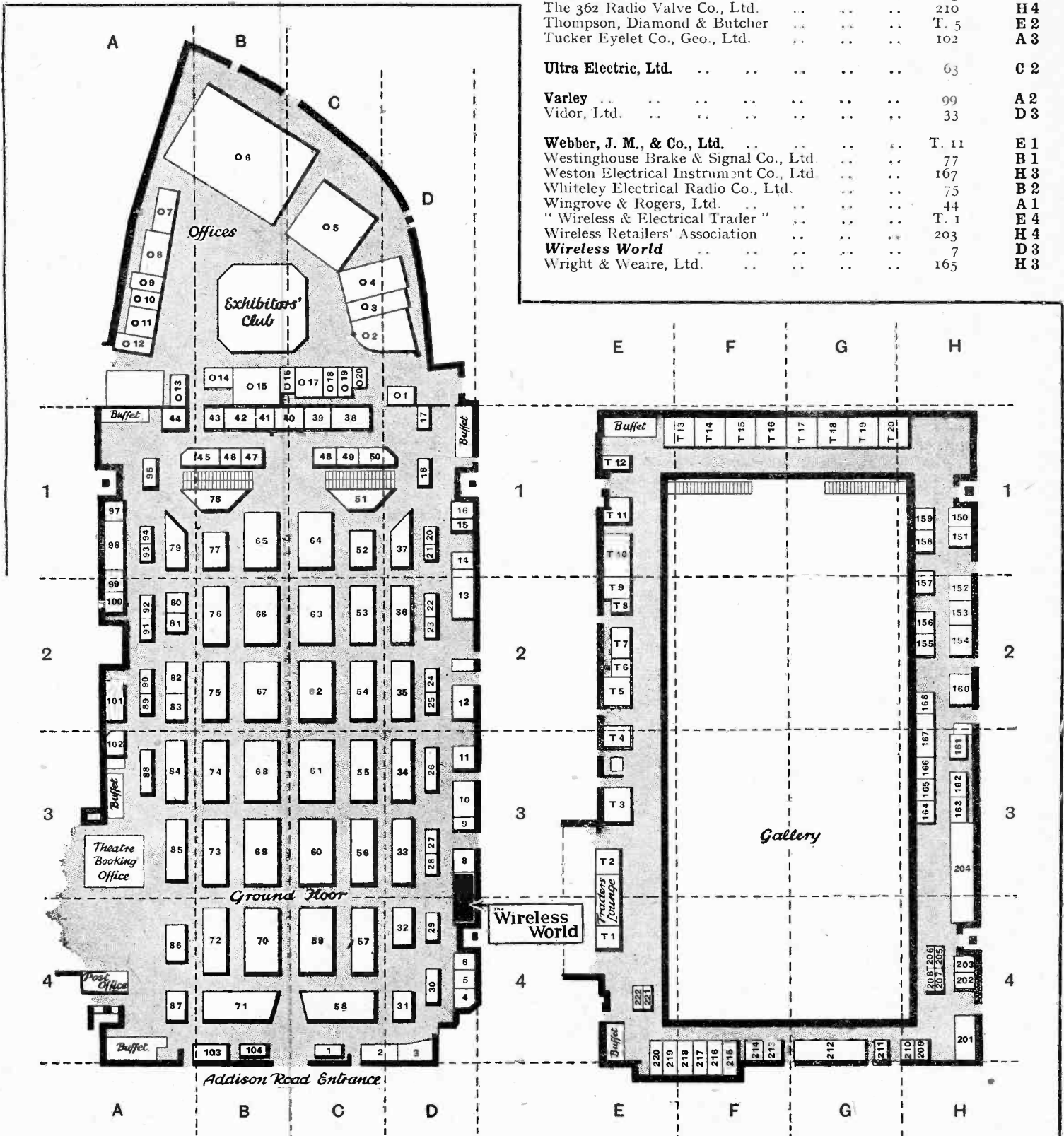

Any Stand in the Exhibition can instantly be located by using this squared plan in conjunction with the references shown in black type in the accompanying list of exhibitors.

# Receiving Aerials

TYPES BEST SUITED FOR BROADCASTING, SHORT-WAVES AND THE ULTRA-SHORT WAVES

SO much has been done in recent years to improve the sensitivity and performance generally of receivers that to-day very good results can be obtained with quite short and inefficient aerials. This has fostered the idea, particularly among broadcast listeners, that the aerial is of little or no importance.

So far as it affects the reception of a local station it may have some justification, since the signals are usually of such strength that with the set operating at comparatively low sensitivity it fully satisfies the requirements of home listening.

On such occasions, however, when it is desired to listen to more distant stations the pooriness of the aerial begins to show up, though not necessarily in the form of weak signals, for the set will have sufficient reserve sensitivity to cope with small inputs, but background noises will be greatly increased.

The set then becomes very responsive to small electrical disturbances, which, when listening to the local station, were possibly inaudible, yet may now become troublesome.

If the sensitivity of the set could be lowered and still give a good signal on the distant stations the programme would in many cases be far more enjoyable.

Listeners who have hitherto been content with a few yards of wire run round the picture rail in a ground-floor room can

By H. B. DENT

Aerials rarely receive the attention they should, yet none, it is hoped, deteriorate to this state. This sketch appeared in THE WIRELESS WORLD illustrating a reprint of a talk on aerials broadcast by the Editor from the London transmitter 2LO in 1924.

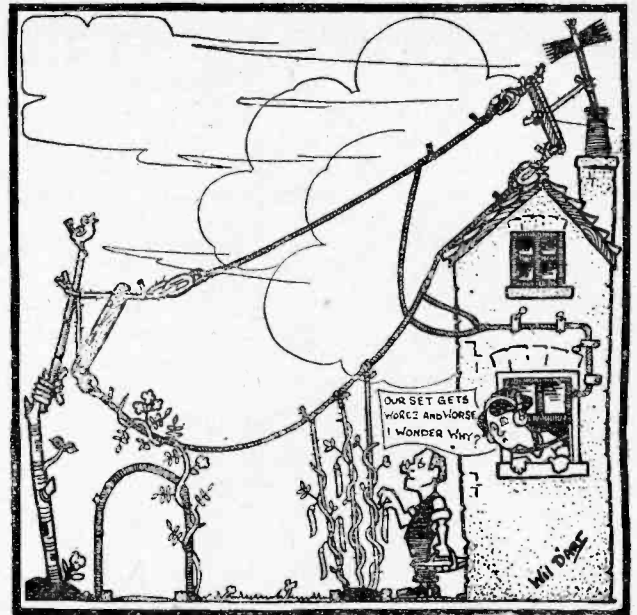

effect a very marked improvement in distant-station reception by replacing it with a moderately good outdoor aerial, or if this course is for some reason or other impractical, by an aerial erected in the loft of the house. Height is the main factor in an aerial system, no matter whether it be for broadcast reception or for such special purposes as short-wave and ultra-short-wave reception.

It becomes more apparent perhaps when listening on the short waves as, in general, signal strengths are so much lower than on the normal broadcast bands, yet what is necessary in the one case is obviously desirable in the other if really satisfactory results are to be achieved.

For ordinary broadcast listening the main points to consider are height, good insulation and freedom from losses. The last-mentioned concern mainly the way in

which the downlead is run, and provided it is kept well away from metal pipes and adequately insulated where it enters the building it will be quite satisfactory in other respects. Of course, if there are any joins in the wire these should be well soldered and preferably wrapped with good insulating tape.

It is also advisable to make some arrangement to protect the receiver in the event of the aerial being struck by lightning. The possibility is remote, but precaution is always a good policy, and either a lightning arrester, of which there are many varieties now available, or a good earthing switch *outside* the building should be installed.

The aerial system does not finish with the elevated wire, but the earth connection is almost equally as important. A good "earth" must be provided, and this might conveniently be a mass of wire netting with the earth wire woven into it and buried in the ground. Any considerable area of metal will suffice. Alternatively, a long metal rod or tube hammered into the ground makes quite a satisfactory "earth."

## Broadcast Aerial

With modern sets an aerial consisting of a 30- to 40-ft. horizontal portion raised 25 to 30ft. above the ground will, with the down-lead, give an aerial of about 60 to 75ft. long, and this will fully satisfy all broadcasting requirements, even including short-wave reception, for which many of the sets now provide.

If one has been accustomed to listening to the local station or stations with a short indoor aerial only it may happen that when attempts are made to tune in the distant stations on an outdoor aerial interference from electrical appliances may become rather troublesome.

In most cases this form of interference can be eliminated, or at least reduced to a negligible amount, with one of the special anti-interference aerial systems. In order to be effective the horizontal part of these aerials must be raised above the

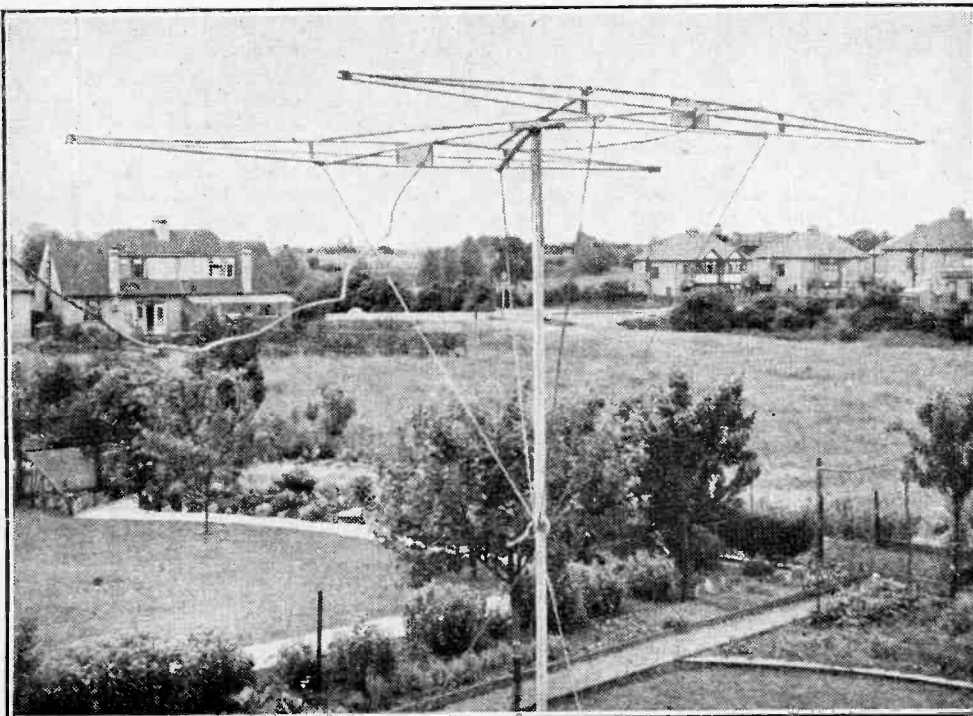

Horizontal five-metre array using a centre-fed, di-pole radiator and reflector.

**Receiving Aerials—**

interference zone which in general rarely exceeds the height of the house and rapidly decreases at any distance from buildings, etc.

The down-lead which, of course, has to pass through the interference zone, is a low impedance screened feeder and consequently is practically immune to the interference, so that if the aerial proper is high enough good reception can be effected.

These anti-interference aerials are now obtainable for all-wave reception covering the short-, medium- and the long-wave bands. Though differing considerably in design, most, however, have a matching transformer where the feeder or transmission line joins to the aerial and another transformer at the receiver end to match the feeder impedance to that of the input of the set.

They cannot very well be made by the amateur, as the all-wave types in particular usually have to be evolved by experiment as the values of the various components are not readily found by calculation but by actual measurements with different coupling systems.

**Short Wave Aerials**

For general short-wave reception it is difficult to find an aerial better than that described for broadcast use.

When, however, it is desired to receive one short-wave station particularly well then the aerial can be designed and erected accordingly. For example, if it should be desired to listen consistently to a station operating in the 17 Mc/s band a half-wave di-pole aerial 27.5ft. long, split in the centre and with a low-impedance feeder joined in at this point will prove a very efficient system. If the station is due east of the receiving site the aerial should run north and south, since this type of aerial is directional at right angles to its length.

For receiving on other wavebands the lower ends of the two-wire feeder can be joined together and the aerial used as an ordinary "T" aerial, when it will not be directional.

The formula for calculating the length of a half-wave aerial is:—

$$\text{Length (feet)} = \frac{492}{F(\text{Mc/s})} \times 0.95.$$

In an average size garden the longest aerial of this type that can be erected is about 60ft. to 70ft. and one 66ft. long will be a half-wave in the 40-metre amateur band. On all other bands, with the exception of the 21 Mc/s band (13 to 14 metres), it will have to be employed as a "T" aerial.

In general, however, there is not a great deal to be gained by using the resonant type of aerial for short-wave reception owing to the rather limited range of frequencies over which it functions in a satisfactory manner.

On the other hand, there is a lot to be gained by using some form of directional and resonant system on the ultra-short waves either for television reception or for the five-metre amateur transmissions.

Owing to the comparatively small size of the aerial—one 8ft. long is a half-wave at 57 Mc/s (5.27 metres)—a very efficient directional system can be designed, assembled and erected by the amateur experimenter. It will not be too unwieldy to erect on a single pole and arrangements can be made to rotate it so that all-round reception may be effected.

Some recent experiments with an aerial system comprising a half-wave di-pole with a reflector behind it have shown that a considerable gain in signal strength is obtained when compared with a plain di-pole of the same height.

The di-poles should be vertical for television but horizontal for five-metres, as most amateur transmitting stations use them this way.

The system is, of course, uni-directional, and for all-round reception arrangements will have to be made to rotate it.

It is not proposed to deal with ultra-short-wave aerials in this article as they were described fully and design data given in an article in *The Wireless World* of May 28th last.

small cabinet unit is used without a baffle extension, and it may be that the diffraction effect which is inherent in the sound emanating from the human head is in some measure present with this form of construction.

The additional compliance arising from

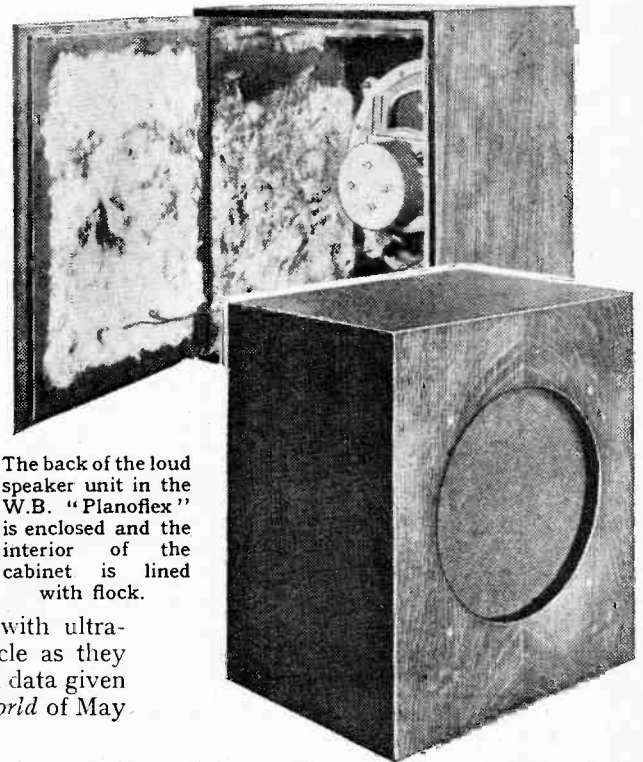

The back of the loud speaker unit in the W.B. "Planoflex" is enclosed and the interior of the cabinet is lined with flock.

**W.B. "PLANOFLEX" LOUD SPEAKER**

IN this new product of Whiteley Electrical Radio Co., Ltd., quality of reproduction has been put before every other consideration. It is freely admitted by the makers that it is not suitable as an extension loud speaker to an ordinary broadcast receiver, and a recommended design for a suitable receiver-amplifier will be included with each instrument.

It works well with *The Wireless World* Quality Amplifier, and we have no hesitation in saying that its performance on all types of reproduction is most natural and lifelike. Even disc recordings seem to be invested with something of the quality of the original when heard through the medium of this loud speaker.

Speech is particularly good when the

enclosure of the back rather offsets the advantage to bass response resulting from complete separation of the radiation from the back and front of the diaphragm. On the other hand, it has a noticeable smoothing effect on the output above the resonant frequency of the system. This is at once obvious from an inspection of the curve of the box unit alone, which is, to all intents and purposes, flat within  $\pm 5$  db. from 90 to over 10,000 cycles (the upper limit of the test gear). The addition of a large plane baffle certainly lifts the bass somewhat, but also tends to exaggerate the 120-cycle peak, so that best all-round results would seem to be indicated from the box baffle alone.

Sensitivity is about 6 db. below that of the average energised or permanent-magnet loud speaker, but few will cavil at that in view of the undoubted merits of this instrument from the quality point of view.

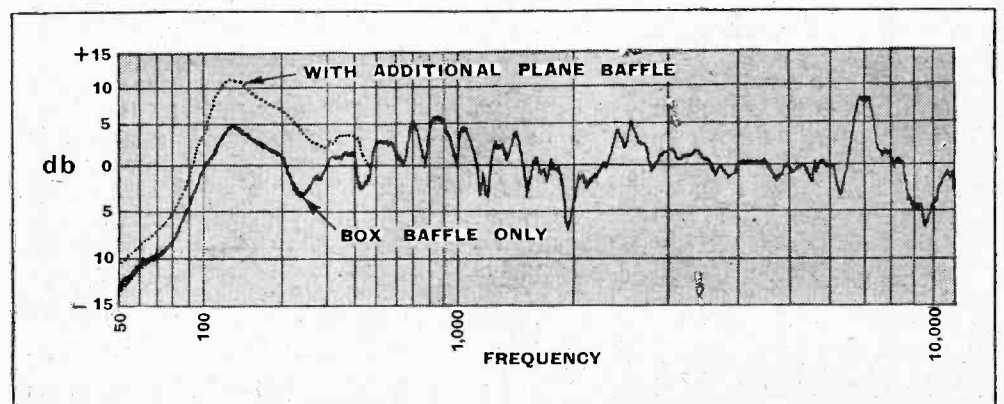

Axial response curve of W.B. "Planoflex" loud speaker with and without additional irregular plane baffle of approximately 22 sq. ft. area. Input 1 watt, microphone distance 4 ft.



# Listeners' Guide for

## Outstanding Broadcasts at Home

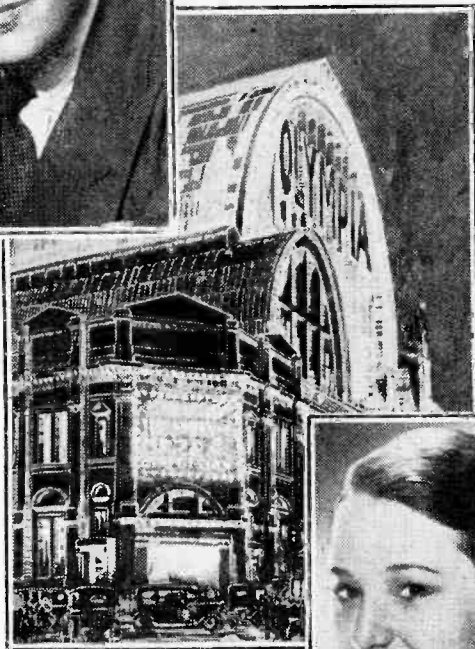

RADIOLYMPIA will provide listeners with a Variety show from the R.M.A. theatre on Wednesday at 8 (Nat.). Eric Coates (inset top), the popular composer, will conduct his own orchestra during this relay. Paula Green (inset below) will be heard during each of the three shows to be relayed during the exhibition.

### SATURDAY'S SPORT

NATIONAL listeners on Saturday will hear commentaries on the sixteenth International Ulster Grand Prix Motor Cycle Race and the County Cricket Matches between Surrey and Yorkshire and Sussex and Somerset. From 1.45 until 2.30 and from 4.15-5.20, the progress of the race over the twenty-and-a-half-mile Clady Circuit, County Antrim, will be described by Graham Walker at Aldergrove, and Raymond Glendenning at the Grand Stand. The roar of the exhausts of the motor cycles ridden by the crack riders of many countries, will give a very good idea of the speed at which they pass the commentators' boxes during the twelve laps of the course totalling 246 miles.

At 1.10 and 5.20 the scheme of giving commentaries on two County cricket matches in progress will be continued. Howard Marshall will be at the Oval, Kennington, to describe the Surrey-Yorks match, while P. G. H. Fender at The Saffrons, Eastbourne, will comment on the match between Sussex and Somerset. The second and third day's play will likewise be described Nationally on Monday and Tuesday at 1.10 and 5.0 each day.

and also because it is at once an allegory, a thriller, a puzzle and a ghost story.

"Yes, and Back Again" will be revived on Thursday at 10.0 (Nat.) and again on Friday next, August 27th (Reg.). Barbara Burnham will be the producer and the incidental music, which is an important feature of the play and is written by Victor Hely-Hutchinson, will be played by the B.B.C. Theatre Orchestra.

### THE AVON

WILLIAM COBBETT wrote of one of his "Rural Rides" in the heart of England—"I never before saw anything to please me like this valley of the Avon." This was one hundred and twelve years ago, and now S. P. B. Mais, the well-known writer, who, with his eager curiosity about life and his extensive knowledge of the English countryside, has something of William Cobbett in him, is going to explore this valley with a volume of Cobbett in his pocket.

In a short programme, "A Rural Ride Renewed," on Sunday at 9.5 (Nat.), he will talk of what he has seen himself of the things that remain in this beautiful Wiltshire valley, and of the changes the years have brought about. It is hoped that he will bring to the microphone some of the valley's inhabitants.

S. P. B. MAIS will explore one of William Cobbett's rides in Wiltshire and, on Sunday, give a talk on his findings.



**T**HE RADIO MANUFACTURERS' ASSOCIATION, in providing a theatre at Radiolympia and engaging radio artistes for the shows there, gives visitors an opportunity of seeing their favourite radio stars in the flesh. At the same time it provides listeners with some really good variety entertainments, for the B.B.C. is, on three occasions, to relay the shows. On Wednesday, the opening day of the Exhibition, National listeners will, at 8, hear "A World of Radio—Vaudeville Ensemble from the Sixteenth Radiolympia." The other two broadcasts from Olympia will be given on Monday, August 30th (Reg.) and on the closing day, Saturday, September 4th (Nat.).

Among the well-known artistes that will be heard this Wednesday are the Two Leslies; Sandy Powell; Jan van de Gucht; Beryl Orde; Paula Green; Vine, More and Nevard; Eric Coates and his Orchestra; and Bobby Howell and his Orchestra. Two Hammond organs have been installed and the organists will, on the occasion of each broadcast, be Donald Thorne and Harry Farmer. It will be interesting for readers to hear these

electro-acoustical instruments, for the principle of the Hammond organ was described in *The Wireless World* of last week.

The programme has been devised by Jack Swinburne, who will also be the producer with Sutherland Felce as compère.

The quarter of an hour preceding the vaudeville show on Wednesday will be devoted to a talk on the Radio Exhibition by Captain R. A. L. Hartman.

### RADIOGENIC

SINCE its production in September, 1930, King Bull's play, "Yes, and Back Again," has been a favourite with listeners and can almost be described as radio's "best seller." At the time he wrote it he was engaged in programme research, trying to find forms of entertainment inherently suitable only for broadcasting, and this play shows how successful he was. It is certainly a play for broadcasting and for broadcasting only. Its popularity depends to a great extent on this fact,



# the Week

## and Abroad

### PROMENADE CONCERTS

SPACE will not permit a full description of all the Promenade Concert relays of the week, which total about nine hours. It will suffice, therefore, to enumerate the main items of each day's programme.

To-night (Friday) from 9 to 9.35 (Nat.), Beethoven's Fifth Symphony will be the only item heard. Saturday brings Trefor Jones singing two pieces from Rutland

**THE FASTEST** international motor cycle road-race in the world, the Ulster Grand Prix, will be broadcast Nationally on Saturday. This photo shows S. (Ginger) Wood, No. 81, winning last year's race by a very small margin from A. R. Foster. His speed averaged 92 m.p.h.



Motor Cycle Photo.

Boughton's "The Immortal Hour," and Marcelle Meyer playing Ravel's Pianoforte Concerto at 8 (Reg.).

Monday's relay at 8.25 (Reg.) brings Florence Austral singing the closing scene from "Gotterdammerung," and the orchestra playing the bridal procession from Act II of "Lohengrin." Helen Perkins will play Prokofiev's Pianoforte Concerto No. 3 during Tuesday's relay at 8.15 (Nat.), when the first English performance of Kodály's ballet music will be given.

Wednesday's concert provides two relays, the first at 8 (Reg.), when the fourth and sixth Brandenburg concertos will be heard. The second at 10 (Nat.) includes Handel's tenth Organ Concerto.

From the Sibelius concert on Thursday two relays will be given. At 8 (Nat.) his Violin Concerto will be played by Telmanyi, and in the second relay from 9.40 (Reg.) will be heard his third symphony.

### CAPTAIN KETTLE

THIS famous figure of fiction, created by Cutcliffe Hyne, will

make his radio debut in an adaptation by Anthony Hall of the episode, "To Capture an Heiress." This adventure of the sea, portraying such a well-known figure, should be well worth listening to. Abraham Sofaer will play the part of the bearded Captain in Max Kester's production to-night (Friday) at 8.0 (Nat.).

### STARLETS

ANOTHER edition of the popular revue, "Children

of the Stars," devised and presented by Ralph Coram, will be heard in the Regional programme on Wednesday at 7. During the twenty minutes of the programme, listeners will hear Frank, Louie and Ronnie Formby, children of the famous George Formby; and Patricia Burke, daughter of Marie and Tom Burke. Ralph Coram, the originator of these programmes, who will also be compère, is the son of the late world-famous ventriloquist, Coram.

### SEVENTH CENTENARY

ELBING, a small manufacturing town on the river of that name, is a fairly important port, and nowadays its shipyards are of considerable importance, particularly those where torpedo-boats are built. It has now come into the limelight because it is sharing its seven-hundredth birthday with its much better-known contemporary, Berlin. A festival programme from the Town Hall and the Municipal Theatre will be broadcast by Königsberg at 8.10 on Saturday.

### FOLK-MUSIC

FROM Brussels 1 at 6 on Saturday comes a programme of Hungarian folk-songs and folk-music arranged for the Hungarian Musical Festival.

Basque folk-lore and folk-songs provided by the Eskualzaleen Biltzarra Folk Choir will be broadcast from Paris PTT on Wednesday at 8.30. A programme entitled "A Grand Tour of the Egerland," will be given by Leipzig at 7.10 on Thursday. It will include orchestral works of Egerland composers, together with folk-music and folk-songs provided by the Leipzig Symphony Orchestra and Egerland Dialect Ensemble.

### SALZBURG FESTIVAL

RELAYS from this great international musical festival continue to appear in the programmes of Continental stations.

To-day (Friday) from 5.0-10.30 (with intervals) Wagner's "The Mastersingers" will be relayed in its entirety by Vienna. The same station at 9.0 on Saturday relays from the Residenz, Salzburg, a recital of Mozartian music. The pianoforte used for this recital will be the great composer's own instrument.

### MISCELLANY

RICHARD TAUBER singing during a concert from the Kur-saal, Ostend, will be heard from Strasbourg at 9 on Saturday.

Phantasies for Wurlitzer organs come from Deutschlandsender at 10.30 on Sunday.

A medley of the latest popular dance tunes arranged by Sune Waldimir, the Swedish Henry Hall, will be heard from Swedish stations at 9.15 on Monday.

THE AUDITOR.

### HIGHLIGHTS OF THE WEEK

#### FRIDAY, AUGUST 20th.

Nat., 7.30, Five Hours Back. 8, A Captain Kettle Adventure. 9, Beethoven Prom.

Reg., 8.40, Ben Oakley and his Orchestra. 9.15, "The Mill on the Floss": George Eliot's play.

#### Abroad.

Leipzig, 6, Concert of Scandinavian music, relayed from Dresden.

#### SATURDAY, AUGUST 21st.

Nat., 1.45 and 4.15, The International Ulster Grand Prix Motor Cycle Race. 8, "Past, Present and Future": Eddie Pola and Jack Hylton.

Reg., 8, "Popular" Promenade Concert. 9.5, Walthamstow Band Festival.

#### Abroad.

Königsberg, 8.10, Festival Programme for the Seventh Centenary of Elbing.

#### SUNDAY, AUGUST 22nd.

Nat., 7.30, Rawicz and Landauer: two pianos. 9.5, S. P. B. Mais' talk on the Avon. 9.35, The Grand Hotel, Eastbourne. Orchestra.

Reg., The Luton Band. 6.45, May Harrison (violin) and the B.B.C. Orchestra. 9.45, Pianoforte recital: Ania Dorfmann.

#### Abroad.

Deutschlandsender, 8, "My Bike, My Radio and Myself." A musical Sunday outing.

#### MONDAY, AUGUST 23rd.

Nat., 6.20, Songs of British Seamen. 7, Monday at Seven, including Ike Hatch. 8, Recital: Peter Dawson. 8.40, Mabel Constanduros Show.

Reg., 8.25, Promenade Concert. 9.35, Harold Ramsay from the Union Cinema, Kingston.

#### Abroad.

Radio Paris, 8.45, Symphony Concert from the Vichy Casino: Conductor, Sir Thomas Beecham.

#### TUESDAY, AUGUST 24th.

Nat., 6.25, The Granada Three—two pianos and organ. 7.15, Enfield Central Band. 8.15, Promenade Concert. 10, Miss Margaret Bondfield on the Labour Party.

Reg., 8, Mabel Constanduros Show. 9, Harry Hopeful's Day in the East Riding.

#### Abroad.

Hamburg, 9.10, "The Caged Bird": opera by Chemin-Petit.

#### WEDNESDAY, AUGUST 25th.

Nat., 7.45, Talk on Radiolympia. 8, "A World of Radio": vaudeville from Radiolympia. 8.55, Summer in the Heart of England.

Reg., 6.45, Men Talking—Discussion on Sunday Observance. 7, Children of the Stars. 8, Promenade Concert.

#### Abroad.

Hamburg, 8.10, "Round the World in Two Hours," with Eros and music as travelling companions.

#### THURSDAY, AUGUST 26th.

Nat., 6.40, Shows from the Seaside VIII: "Cabaret Revels" from Bexhill-on-Sea. 8, Promenade Concert. 10, "Yes, and Back Again."

Reg., 8, Cornish Sports from Camborne. 8.30, Henry Hall and his Dance Orchestra.

#### Abroad.

Munich, 7, Künneke Gala Concert.

# The New Valves

## Progress of the Year to be Exhibited

**D**EVELOPMENTS in valves are now made public as they occur, with the result that this section of Olympia must be regarded as an exhibition of the year's progress rather than as a display of brand-new apparatus. One major development is the fairly general replacement of output pentodes by tetrodes of similar or improved characteristics. Several methods are now known of eliminating the "negative-resistance" kink in the tetrode characteristic, notably the introduction of guide plates for confining the electron stream to a beam and the use of a critical

conductance of 7.0 mA/V. It is fitted with the standard 7-pin base.

Mullard remain faithful to the pentode, and have a large valve, the Pen.428, from a pair of which an output of 28 watts can be obtained. A similar output is given by two Tungram APP4E valves, the rating being for 5 per cent. distortion. This valve is also available under the type number of the PP6E with a 6.3 volt heater consuming 1.35 amperes.

One of the most spectacular changes is the introduction of the International series of valves. These have the American Octal bases, and have characteristics which are in most cases the equivalents of the newer American types. The Marconi and Osram series includes the X63 heptode, the W63 and Z63 variable-mu and straight RF pentodes, the D63 duo-diode, the H63 triode, the DH63 duo-diode-triode, the KT63 and KT66 output tetrodes, the Y63 tuning indicator and the U50 rectifier. With the exception of the rectifier these all have 6.3-volt heaters, and all but the tetrodes consume 0.3 ampere. They are thus suitable for AC, AC/DC and car-battery operation. The rectifier is of the 5-volt type, and takes 2 amperes.

Tungram have a complete range of similar valves under American type numbers, and also a triode-hexode frequency-changer with the Octal base and 6.3-volt heater. This new base and heater rating seems likely to become the future standard, and may eventually supersede the present 4-volt type. This latter is by no means dead as yet, however, and there are plenty of new valves which adhere to it, in particular valves of high efficiency intended for television apparatus.

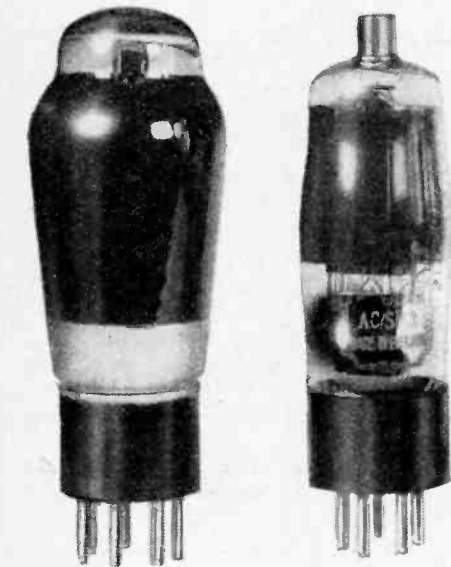

Mullard's new pentode, Pen. B4.

The Mazda AC/SP3 for television work.

spacing of the electrodes. The suppressor grid of the pentode thus becomes unnecessary.

In the Marconi and Osram ranges the KT2 battery tetrode has similar characteristics to the well-known PT2, and there is a new valve, the KT21, which is of very high sensitivity. The mains valves are also becoming tetrodes, and the N42, N30G, MPT4, N41 and N31 become the KT42, KT30, KT4, KT41 and KT31 in the new types.

The Mazda AC4/Pen is, in spite of its name, a tetrode; it has a four-volt heater consuming 1.75 amp., and is rated for 250 volts anode and screen potentials with a grid bias of -7.8 volts. Its anode current is 64 mA. Hivac have a whole series of battery and mains valves in which secondary emission is suppressed by the critical spacing of the anode from the other electrodes. Among these the AC/Q and AC/Qa are the equivalents of the American 6L6 type. The AC/Q has a 4-volt heater and the AC/Qa a 6.3-volt heater and the Octal base.

Cossor have also adopted tetrodes for the construction of the 220 OT and 42 OT valves. The former is a battery valve, and the latter a mains type with a mutual

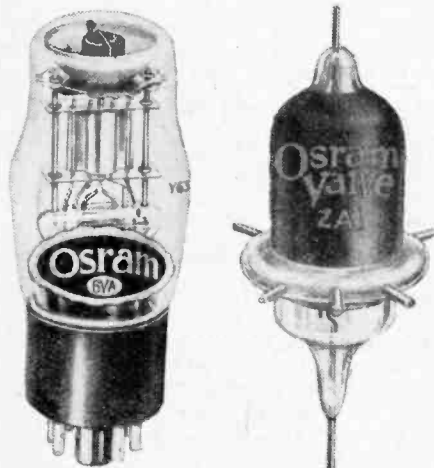

The Osram Y63 tuning indicator with American-type Octal base.

Actual size reproduction of the Osram ZA1 RF pentode.

Among this class the Marconi and Osram MSP41 and the Mullard TSP4 high-g RF pentodes have been known for some time. A newcomer is the Mazda AC/SP3 with a mutual conductance of 7.6

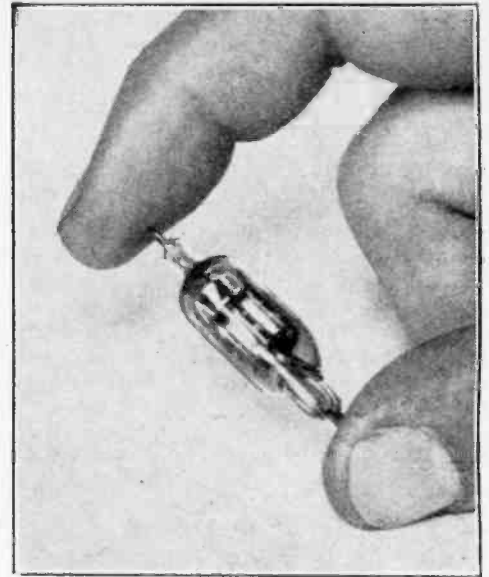

The diminutive size of Mazda's midget diode D1 can be gathered from this photograph.

mA/V at a cathode current of 16.85 mA. This firm also has a diode of small dimensions and without a base; this is done to keep the capacity at a minimum, and it is intended that the valve be hung in the wiring. A special triode, the AC/P4, with a top-anode connector, is available for the output stage of time-bases, and is rated for anode potentials up to 600 volts.

Cathode-ray type tuning indicators have now firmly established themselves, and are to be found in the lists of nearly all firms. Tungram have a modified type in which a space-charge grid is introduced between the cathode and target-screen. By reducing and making more uniform the target current it is claimed that this prolongs the life of the fluorescent screen. Four models are available with different bases and heater ratings.

Little change has apparently taken place in frequency-changers recently, most firms having settled on the triode-hexode, especially for ultra-short-wave receivers. Tungram have a model with an Octal base, but most frequency-changers with this base are of the heptode type. Marconi and Osram, however, have a hexode, the X64, which is intended for use with a separate oscillator. Tungram have adopted this course in their battery range, and have produced a hexode mixing-valve and also a new triode of high efficiency.

For ultra-short-wave receivers Osram now have an RF pentode of the Acorn type. This is the ZA1, and it has a mutual conductance of 1.1 mA/V; it has a heater consuming 0.25 ampere at 4 volts. This firm has also introduced new low-power transmitting valves. The PY5 is a pentode with a directly heated filament; the anode and screen dissipations are 40 and 10 watts respectively. It is intended for use as an oscillator, RF amplifier, or frequency-multiplier, and modulation may be effected on the anode, control or suppressor grids. The anode is brought out to the top of the bulb.

The DET12 is a triode with the anode and grid connections brought out at the top of the bulb; it is designed for opera-

**The New Valves—**

tion between 60 Mc/s and 300 Mc/s, and at the lower frequency will give an output of 60 watts and no fewer than 13 watts at 300 Mc/s.

New Mullard transmitting valves include the PZ1-35, a pentode rated for 35 watts anode dissipation. At 15 metres an output of 10 watts can be obtained with 100 per cent. modulation, effected in the

suppressor with an input of 95 volts peak AF only. The RF drive is 1 watt at 150 volts peak. This output is for 22 watts anode dissipation.

For the high-voltage supply for cathode-ray tubes Mullard have introduced an indirectly heated rectifier, the HVR2, which is rated for an output of 3 mA. at 6,000 volts and at 20,000 volts peak inverse. A neon voltage-stabiliser is also shown.

## Random Radiations

**From the Outposts**

THE other day I met an old friend who has just retired after some thirty years spent in different parts of the Empire. During the past few years he has been living in places as far apart as Hong Kong, Jamaica and South Africa. Both he and his wife were loud in their praise of the Empire broadcasting transmissions from Daventry, saying that they hardly knew how they had managed to get along without them in the old pre-short-wave days. Wherever they had been in recent years they had always managed to obtain pretty good reception, and only on rare occasions when conditions were phenomenally bad did they have to miss the Home news bulletin. That's a fine tribute to the B.B.C. and the Daventry short-wave station. Now that the new transmitters are taking over, reception should be consistently good in most parts of the Empire.

**A Fly in the Ointment**

But if my friend was full of praise for Britain's short-wave station, he had none of it left for the British-made radio receivers that had been offered to him in different parts of the world. He needed a battery set for obvious reasons and was quite prepared to pay a good price for it. In point of fact he did pay the equivalent of nearly twenty-five pounds, but he had to spend his money on an American set. I think that our manufacturers are now awakening to the possibilities of the Empire market, and I know that some of them are turning out receiving sets of the right kind. But it is certainly a fact that until recently it has been most difficult in many parts of the Empire to find a British-made receiver suitable for the work in hand and robust enough to stand up to the local conditions of dust, heat and damp that may be encountered.

**The Little Nationals**

THE B.B.C. remains deaf to the complaints of those—and they are many—who are now unable to hear the National programme properly until five o'clock in the evening owing to the silence of the London and North Nationals. London itself is one of the places worst affected, for in many parts of it man-made interference is so bad on the long waves that Droitwich is all but useless. It seems an astonishing position that the National programmes should be unreceivable save for seven hours out of the 24 in the Metropolis of all places! The reason why the two little Nationals are silent for so long each day is a queer one. Here it is, straight from the horse's mouth: To serve the Scottish schools adequately with instructional broadcasts it is necessary to transmit them from the Scottish Regional and Burghead on 391.1 metres. Therefore (I can't quite follow that "therefore"), it

**By "DIALLIST"**

has been decided to radiate the National programme from these stations until 5 p.m. This being so, the Scottish National on 261.1 metres has to be used for the alternative Regional programmes during the mornings and afternoons. As London and North are synchronised with it, they could send out only the Regional programme—which would be absurd.

**Left Wondering**

There seems to be a whole heap of things to criticise in the official explanation just quoted. One that sticks right out is that the interests of a vast body of listeners in the London and North areas are apparently being sacrificed to meet the needs of Scottish schools. But there is more in it than that. The explanation can hold good only for school term-time. For the best part of two months now there have been no schools' broadcasts. During that time Burghead and Scottish Regional have been giving the Regional programmes all day long and the *Scottish National has been relaying Droitwich from 10.45 a.m. until midnight.* Why, then, should not its synchronised sisters, London and North, have done the same? Again, if it is essential to use the 391.1-metre Scottish stations from 10.15 a.m. till 5 p.m. for the National programme during term-time and to send out the Regional programme from the Scottish National, why not make the same change-over in the duties of the London transmitters? Everyone would then be able to hear both programmes. Or, simpler still, if we must have schools' broadcasts, put them into the Regional programmes. After all, they occupy only about three hours a day.

**Wireless and Measles**

TO me the broadcasts for schools, as conducted in this country, have always seemed something that should be the pdigin of the Board of Education rather than of the B.B.C. I feel, too, that though it may be an excellent thing for schools to hear occasional talks by wireless of subjects outside the normal curriculum, ordinary subjects are best taught to classes and forms by their own masters and mistresses. here's a world of difference between lecturing (which is all that microphone and loud speaker can do) and *teaching*: the personal instruction of a class, every member of which is known intimately to the teacher. In Australia they have found a use for school broadcasts which seems to me altogether admirable. Some kind of infectious infantile ailment made its appearance. The schools were promptly closed and instruction was continued by wireless. In this country we have a way of putting off closing until there are few pupils left to be taught!



### SPECIAL 9-VALVE FOUR-WAVE SUPERHET DE LUXE

The De Luxe Model of this exceptional receiver includes many interesting features, and combines unusual sensitivity with great flexibility of control. Only receivers now on the market at very much higher prices can claim so high a standard of design and performance.

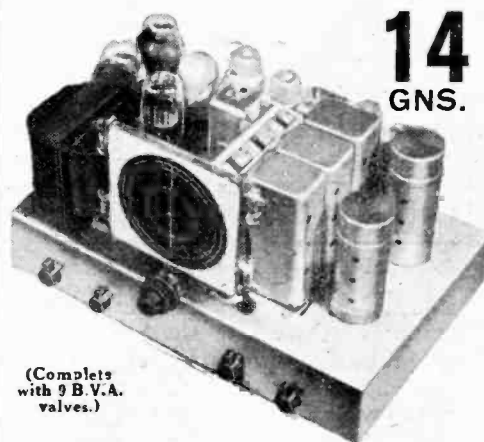

**14  
GNS.**

(Complets  
with 9 B.V.A.  
valves.)

4 wavebands: 12.8-33, 29-80, 190-550, 800-2000 metres. Illuminated dial with principal station names.

**Controls.**—A feature of the receiver is the number of independent controls fitted, making it extremely interesting to operate. These include: sensitivity control (varying bias on R/F stage). Q.A.V.C. with manual muting control for inter-station noise suppression. 5-position wave-change and gramophone switch. Progressive variable tone control operative on radio and gram.

**Circuit in Brief.**—Aerial input to pre-selector circuit, radio frequency amplifier, latest type triode-hexode frequency changer. 2 band-pass I.F.T. coupled I.F. amplifiers, double diode detector, L.F. amplifier and special push-pull pentode output stage. Heavy cadmium plated steel chassis. Finest components and workmanship throughout.

Harries' tetrodes can be fitted in place of pentodes in output stage if desired.

A.C. models ready for immediate delivery. A.C./D.C. models also in production, and will be available for delivery shortly.

**STANDARD MODEL 12 GNS.**

as above, but with triode push-pull output, and fewer controls fitted.

**DEFERRED TERMS**

on application or through our City Agents  
**LONDON RADIO SUPPLIES LTD.,**  
11, Oat Lane, E.C.2.

Demonstrations Daily.

All McCarthy receivers supplied complete with valves, knobs, pilot lamps, leads, mains cable and plug. 12 months' guarantee. (Valves 3 months.)

The prices at which McCarthy receivers are advertised include Marconi Royalties.

Cash with order on 7 days' approval. Also write for illustrated catalogue of complete range of all McCarthy receivers.

**MCCARTHY RADIO LTD.**  
44a, Westbourne Grove, London, W.2

Telephone: Bayswater 3201/2.



# Components and Accessories

AS television will be a prominent feature in this year's Show, there would appear to be some justification for expecting a spate of new components developed exclusively for use in television sets. Expectation may not, however, be fully realised, yet the special parts needed for home construction will not be lacking, as ultra-short wave reception is not a new

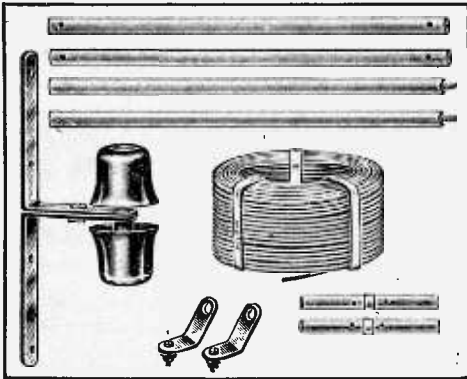

Bulgin television aerial kit.

subject, and amateurs have been experimenting on these very short wavelengths for several years. Most of the components that are used for this purpose are equally well suited for use in television sets. Where the special requirements of television are not catered for by existing ultra-high frequency components, the deficiency is made good so that there will be an adequate selection of parts for this purpose.

Bulgin will be showing some wide-band IF transformers covering a range of 20 to 8.5 Mc/s—15 to 35 metres—and giving an ostensibly flat response over 3 Mc/s. Included in this new series are some RF transformers for use in vision frequency amplifiers and also having a band-width of 3 Mc/s. No doubt Stratton & Co., who specialise in short and ultra-short wave components, will be showing also many new items developed especially for this purpose, but full details of them are not as yet available.

The type of aerial that at present is much favoured for television reception is a half-wave di-pole with a low-impedance feeder joined to its centre. Bulgin has developed two aerials of this pattern. One is an inexpensive arrangement which costs 7s. 6d. and can be attached to the side of a house or mounted on a pole, while the other is described as a *de luxe* version for which copper rods and stand-off insulators are used. The price of this model is 30s. Both aerials are designed to resonate at 45 Mc/s—6.67 metres—which favours the vision signals of television and is generally accepted to be the best compromise when both vision and sound are received on the same aerial. A low-impedance feeder 50 feet long is in-

cluded in these ultra-short wave kits.

Belling and Lee are including among their new season's components and accessories a range of television aerials also. They are the half-wave di-pole type for masthead or wall fixing, and some of the models are fitted with a reflector.

The addition of a reflector is more than a mere refinement, and an aerial so equipped does give a much stronger signal than the plain di-pole. Its advantages are best felt in situations where signals for one reason or another are very poor, or where some electrical interference is experienced. With it a better signal-to-noise ratio is achieved.

This firm also make an ideal low-impedance feeder, or transmission line, for use with the Hertz or resonant type of aerial, in which category is included the television aerials. It is known as No. 344 cable and has an impedance of about 80 ohms, which is a satisfactory match for the centre of a half-wave di-pole.

Transmitting experimenters will find this cable very useful, as it functions quite efficiently down to five metres. It costs 10s. 6d. for 65 feet.

High-voltage components for use in television sets first made their appearance last year, and since then many improvements have been effected. With the greater demand occasioned by the establishment of a regular television service, the ranges of most makes have been extended and their prices will be found not unreasonable, considering the care that must be exercised in manufacture and the high margin of safety that must be allowed.

Bulgin has developed some high-voltage condensers, using oil-impregnated paper as the dielectric. They are made in capacities of from 0.001 mfd. to 0.1 mfd. The peak DC volts they are rated to stand varies from 2,000 volts for the former to

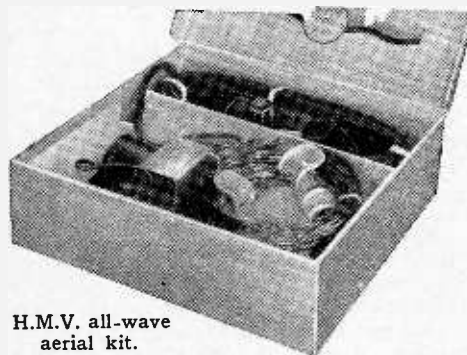

H.M.V. all-wave aerial kit.

5,000 volts for the latter, their respective prices being 2s. and 9s. each. There are five condensers in this series.

High-voltage condensers will be shown also by T.C.C. and by Dubilier. In the latter's oil-immersed series condensers for a working voltage of 6,000 are now obtainable.

Apparatus that  
Manufacturers Will  
be Showing at  
Olympia

In addition Dubilier will have a comprehensive display of mica and paper dielectric condensers, also electrolytics in a wide variety of types. In the moulded mica series a new style is the Type 690W which is fitted with connecting wires in place of soldering tags.

Their range of resistances will include a series of insulated models while an extended series of metallised volume controls will be shown.

A special feature will be made by T.C.C. of the voltage regulating qualities of their aqueous-type electrolytic condensers, but mica and paper dielectric condensers as well as dry electrolytics in a wide variety of types will be shown.

The high voltages required by cathode-ray tubes are, of course, obtained from AC, the voltage being transformed up to the working potential, then rectified and smoothed. The special mains transformers needed for this purpose need to be well insulated, but the problem is not a

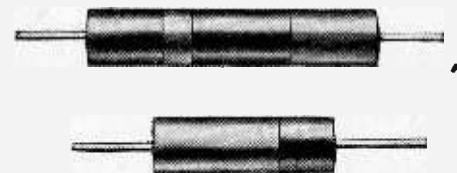

Dubilier new insulated metallised resistances.

particularly difficult one, since voltages of 6,000 or more are insignificant compared with those dealt with as a normal matter by electrical engineers. To the radio engineer, and particularly to the amateur experimenter, they are somewhat abnormal.

All Power Transformers will be showing a series of high-voltage mains transformers giving output voltages of 2,000, 3,000-4,000 or 4,000-6,000 AC, also some special smoothing chokes designed for use in 6,000-volt DC circuits.

Sound Sales will probably have some models of this kind for examination, as mains equipment is a subject in which they specialise, though we have not yet received details of them.

In connection with high-voltage matters, the exhibit of Mica and Micanite Supplies, Ltd., will be of interest, since the materials in which they deal are used very largely for insulating purposes.

Metal rectifiers designed for handling the AC output from both high- and low-voltage transformers will be a feature of



**Components and Accessories—**

the exhibits of Westinghouse Brake and Signal Co.; their special models for use with CR equipment will interest the television experimenter.

So far as radio components of the more orthodox type are concerned, a few changes and additions are likely to be seen this year. Wingrove and Rogers retain the bar-type condenser with no apparent changes, and this style is now being made their standard model for the coming

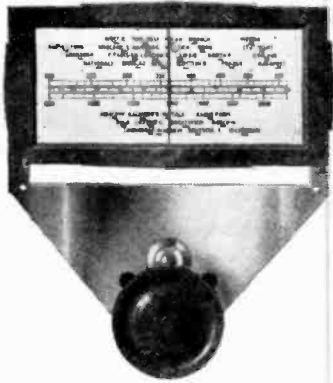

Polar New Micro Drive.

season. It will be shown in single, two- and three-gang types, but not as a four-gang, the Polar Midget four-gang being retained to satisfy these requirements. All other models of the Midget are withdrawn. The single condenser with bar-construction is, incidentally, described as the No. 5.

This firm has introduced a new version of their Micro Horizontal condenser drive, which has both station names and wavelengths engraved on the dial. It is a two-ratio model giving a coarse drive of 10:1 with a second reduction to 50:1, the latter being nicely suited for short-wave tuning. This new dial costs 9s. 6d.

Several new coils and coil units have been developed by Bulgin, the Square Can series being of the skeleton or manufacturer's pattern for mounting on metal chassis, and having flexible wires coming through the base. This new series includes aerial and oscillator coils, also IF transformers for 465 kc/s. A reaction winding is provided on one of the IF units and another is designed for variation in the band-width, the variable-selectivity feature being obtained electrically by a tertiary winding shunted by a variable resistance. The price of these coils range from 5s. to 6s. 6d. each.

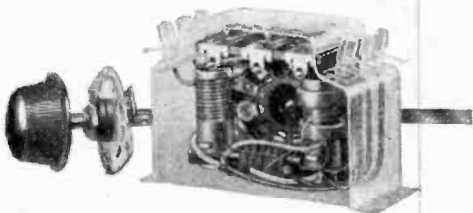

Wearite Triogen three-range coil unit.

Among the new products of this firm is a five-range coil unit covering 5 to 2,000 metres, and an oscillator coil for 465 kc/s to match. The latter contains all padding condensers, but switches are not em-

bodied, the Bulgin 5-way switch assembly being intended to be used. Several coil units can be used and their switches operated by a common shaft. The aerial coil costs 21s. and the oscillator unit 30s.

Wright and Weaire will have a new all-wave coil unit described as the Triogen coil. It has built-in wave-change switch and trimmers, and covers 19-48, 200-550 and 900-2,100 metres, respectively, on the three bands when using a 0.0005 mfd. condenser.

Provision is made for ganging several units by using a loose spindle which can be of any length. The locator plate is part of the spindle fitting. The coil costs 9s. 6d. and the spindle, with locator, 1s. 6d. Wearite also will have a good representative range of coils, as well as IF transformers for 465 kc/s and 110 kc/s.

Another firm that has introduced and will be showing coils with loose wires in place of terminals is Varley. So far as present information goes, only IF transformers are being shown in this form. Three are for 465 kc/s and two for 110 kc/s operation. Either pattern can be supplied with a lead coming out of the top of the can for top anode or top grid valves.



Varley 465 kc/s Duo Nicore IF transformer.

One of the 465 kc/s models, the BP124, is a variable - selectivity type; it includes an auxiliary winding and band-width expansion or contraction is effected solely by electrical means. This model costs 8s. 6d., but the price of the others in this series is 7s. 9d. each.

Two- and three-

gang Nicore coil units mounted on a small chassis with waveband switching in the base are new additions to the Varley range. The two-gang model, which has the type number BP120, has a short-wave band in addition to the medium and the long. When tuned by a 0.0005 mfd. condenser the coverage is 17-50, 200-550, and 800-2,000 metres respectively. This model is priced at 19s. 6d.

The early Bulgin Electronic HT vibrator has now been superseded by others designed for operating from 4-, 6- and 12-volt batteries. The four- and twelve-volt models are of the self-rectifying variety, but the new 6-volt model requires a separate rectifier. One universal vibrator transformer now serves all purposes and this gives a maximum output of 250 volts at 60 mA. DC. It can be used with either the 4-, the 6- or the 12-volt vibrators.

Vibrator units will be shown, also, by All Power Transformers, which firm have three types for 6- and 12-volt input. One

Quaint IDEAS  
YOU ACCEPT WITHOUT  
QUESTION....

NUMBER TWO



that  
**PANAMA HATS**  
are made in Panama

A REAL Panama hat, which costs anything up to £20, comes not from Panama but from Ecuador or Colombia. Wear an honest Panama or an imitation, as a head covering either serves equally well.

With condensers it's a different story. A condenser must fulfil a hundred and one different conditions, unfailingly it must answer as many critical demands. Condenser making is a specialist job... there is no substitute for a T.C.C. So when you need a condenser, be guided by this—

**A PROVED FACT**

T.C.C. CONDENSERS ARE THE ACCEPTED STANDARD OF CONDENSER EFFICIENCY. THE NATURAL OUTCOME OF 30 YEARS SPECIALISATION.

SEE THE FULL RANGE ON STAND 38 RADIOLYMPIA



**T.C.C.**  
ALL-BRITISH  
**CONDENSERS**

The Telegraph Condenser Co. Ltd., Wales Farm Rd., N. Acton, W.3

**Components and Accessories—**

of the self-rectifying models gives an output of 250 volts at 70 mA, DC.

The requirements of the battery-set user

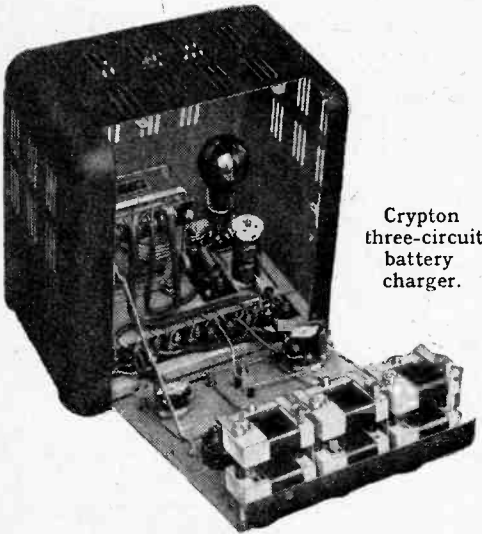

Crypton three-circuit battery charger.

will be as well catered for this year as in the past. The dry battery is such a convenient form of power supply that it could not very well be dispensed with, and most amateur experimenters find many uses for it, apart from operating a set.

All the well-known battery firms will have many models to show and, without exception, their ranges have been extended either by new models or by batteries of particular shape and size for receivers of one make or another. Britannia Batteries

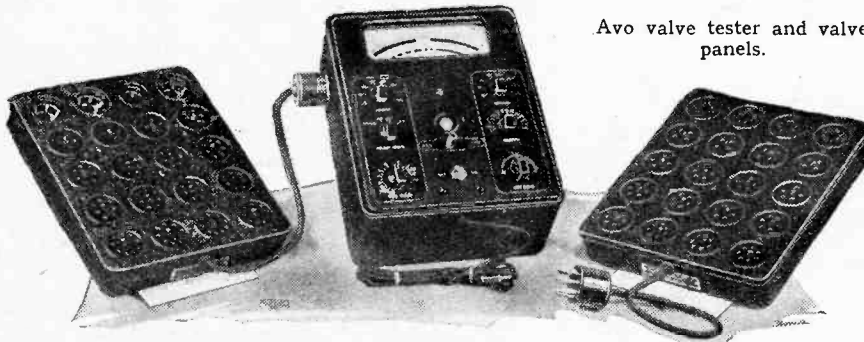

Avo valve tester and valve panels.

have developed some dry LT batteries, but unfortunately only for export. No doubt many listeners living in country districts would welcome an LT supply of this nature.

The smallest unit of the series is claimed to have a capacity of 270-ampere-hours which, on a load of 0.3 amp., would have a working life of between 900 and 930 hours. At double the current the working life is halved.

British G.W.Z. will be showing a special group of batteries for overseas use as well as a comprehensive range of their standard batteries. Other firms catering for the battery user are Exide and Drydex, Ever Ready, Fuller, G.E.C., Marconiphone, Milnes Radio, Siemens, and Sterling Batteries. Should any further evidence of the popularity of battery sets be needed, one has only to take note of the many firms that will be showing battery-charging equipment.

All Power Transformers will have several models for home use and so, also, will

Heyberd, the Tom Thumb Charger made by the latter firm being of more than usual interest in view of the fact that it measures only  $3\frac{1}{2}$  in.  $\times$   $2\frac{1}{2}$  in.  $\times$   $2\frac{3}{8}$  in., yet it charges a 2-volt accumulator 0.5 amp.

Crypton Equipment make a speciality of the large units used in battery service stations, though they will be showing some small models for garage use and for charging 6- and 12-volt starter batteries. Heyberd also have a range of units for service-station use, and another firm that deals almost exclusively in this class of apparatus is Partridge, Wilson & Co. Their Davenset series of battery chargers is well known, and a full range of models will be shown. A magnetic overload protection device is one of the outstanding features of this firm's equipment. Radio service-station engineers will be interested particularly in the Type HT5, which is expressly designed for dealing with radio batteries.

An extensive series of battery chargers using metal rectifiers will be shown by the Westinghouse Brake & Signal Co., together with some new and interesting models of their rectifiers.

A section that has expanded considerably in recent years, in view of its importance to the radio industry, is that devoted to testing and servicing equipment.

The Automatic Coil Winder Co. recently added a new instrument, a valve-testing unit, to their range of serviceman's apparatus, and this will, of course, be

available for examination at the Show. It operates entirely from the AC mains, and gives a direct reading of mutual conductance in mA/V. The scale is also divided into three sections, differently coloured and signifying good, doubtful and bad, so that dealers and servicemen can more easily convince their clients, should it be necessary, that a faulty valve is indeed faulty. For a value of mutual conductance that is much below the average would not necessarily carry the same weight as a reading of "Bad."

The Avo Capacity Tester, the new Avo Oscillator, and the Avometers, including the latest 46-range model, together with the various Avo Minors, will make an imposing array of servicing and testing equipment.

The latest 46-range Avometer, which is known as the Model 7, is of outstanding interest, since it enables almost every possible test to be made with a single instrument.

Everett Edgcombe will be showing an

enlarged range of Radiolab servicing and testing apparatus. The newest model is described as the Valve Gauge. As its name signifies it is for testing valves, and indicates on a coloured scale whether a valve is good, bad or indifferent. Emission and mutual conductance tests can be made, also a test for inter-electrode insulation. It is AC-mains operated and will deal with all types of valve in general use, and it costs £5 15s. 6d.

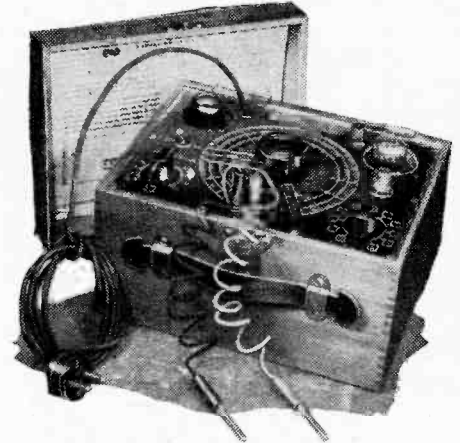

Hunt's Capacity Analyzer.

The Radiolab Service Valve Tester, a more elaborate instrument, with which a complete analysis of the condition of any valve can be made, has been improved and sundry refinements embodied.

A cathode-ray tube electrostatic voltmeter is another new addition. It is a three-range model, and can be supplied with full-scale readings of 1,500, 3,000 and 6,000 volts, or with 2,000, 4,000 and 8,000 volts. The price is £7 8s. 6d.

These represent but a few of the many servicing units in the Radiolab range, for, in addition, there is the All-purpose Tester, a modification of which is now fitted with a large 6in. meter, the Omni-Selector, All-wave Oscillator, and sundry other useful units.

A. H. Hunt will be showing, among other items, a new All-wave Signal Generator and a Capacity Analyzer. The former is a portable self-contained unit with six frequency ranges covering on fundamentals 30 Mc/s to 100 kc/s. The sixth range utilises harmonics of range five, and extends the scope of the instru-

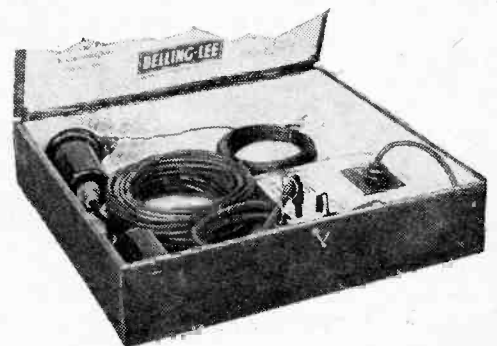

Eliminoise aerial kit made by Belling-Lee.

ment to cover the ultra-high frequency band and television, its range being 20 to 60 Mc/s.

**Components and Accessories—**

A new measuring bridge for resistance and capacity has been developed by Radiometers, and will be shown by them under the appropriate name of Farad-ohmmeter. It has a visual indicator for balance, and all measurements are read off from calibrated scales. The resistance range is 50 ohms to 4 megohms, and its capacity range is 50 m-mfds to 25 mfds. It can be used as a battery-operated portable instrument or as an accessory to the All-valve Tester, under which conditions it takes its operating voltages from this set. The price is £5 5s.

Several interesting servicing and test instruments will be shown by Norman Rose, which firm will have a valve-emission tester, multi-range measuring and test set, and a radio receiver analyser.

Telsen make their debut as manufacturers of servicing equipment with a long range of instruments, all of which have many features of interest. The Telsen Universal Tester is designed for testing any type of valve in general use, as well as answering as a general-purpose instrument for the serviceman. As a DC voltmeter it provides three ranges, viz., 0-12, 0-120, and 0-1,200 volts. One range, 0-1,200, is included for AC volts. On all voltage scales the resistance is 1,000 ohms per volt. There are two ranges for capacity

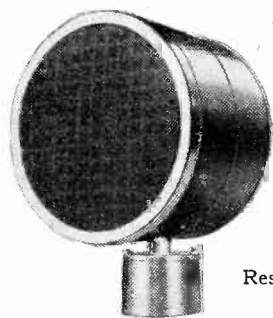

Reslo Type PR moving-coil microphone.

measuring element covering condensers of from 0.002 to 4 mfds. As an ohmmeter it covers 0-500,000 ohms in two ranges.

Another unit of interest is the Multi-meter. This is an eleven-range instrument fitted with a 3½ in. moving-coil meter and having a resistance of 1,000 ohms on all voltage ranges. Three ranges are provided for both AC and DC volts, and these read, on full scale, 0-12, 0-120, and 0-1,200 respectively. The DC current ranges cover 0-12 mA, 0-120 mA and 0-1.2 amps., while two resistance ranges enable measurements to be made over a range of 0 to 50,000 ohms. An output meter and a valve-voltmeter are included in this series.

The Weston Electrical Instrument Co. will be showing a new Super Sensitive Analyser, the Model E772. Though basically similar to their earlier Model E665, it has a longer scale, thus simplifying reading, and on all DC voltage ranges the resistance is of the abnormally high value of 20,000 ohms per volt. This means to say that the meter used must give a full-scale deflection with only 50 microamps.

There are five ranges for both AC and DC voltages, these being 1,000, 250, 50, 10 and 2.5 volts full-scale readings respectively. For DC current measurement the ranges are 500, 50, 10 and 1 mA,

also 100 microamps., while for AC the current ranges are 5 amps., and 0.5 amp. respectively.

Resistance, capacity and power output measurements can also be made with this

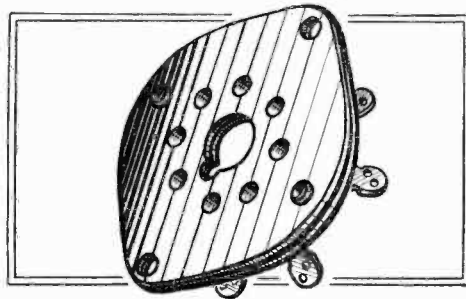

Clix Octal-base valveholder.

instrument, the price of which is £22 8s. Weston will have several other units, and a range of meters designed and intended for the use of servicemen and experimenters.

The full range of testing equipment made by Wright and Weaire will be available for examination, but apart from a small increase in price there are no apparent modifications to the current units. Another firm that will be showing testing apparatus for servicing and general experimental use is Bulgin, which firm has developed quite a number of new and interesting models.

Salford Electrical Instruments are to show a "Q" meter, which gives direct readings of coil efficiency in terms of Q values from 25 to 500. Measurements can be made over a frequency range of 100 to 6,000 kc/s.

There will be included also an "L" meter for measurement of coil inductance from 1 microhenry to 5 millihenrys, and a "C" meter covering a capacity range of 100,000 m-mfds. All these instruments are mains operated. In addition, a range of miniature voltmeters and ammeters, a multi-range test set, and a series of laboratory-type valve-voltmeters will be shown.

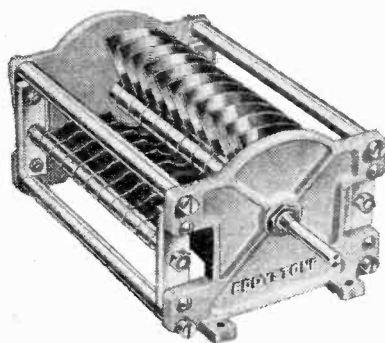

Eddystone transmitting condenser made by Stratton.

A Ganging Oscillator embodying many novel features will be seen on the stand of A. C. Cossor. Its uniqueness lies in the fact that it is designed to work in conjunction with their CR Oscilloscope, the sweep voltages from which can be applied to the oscillator so as to "wobble" the frequency ±15 kc/s above and below the fundamental. Thus it can be used for

# POINTS OF IMPORTANCE in the Rola G.12

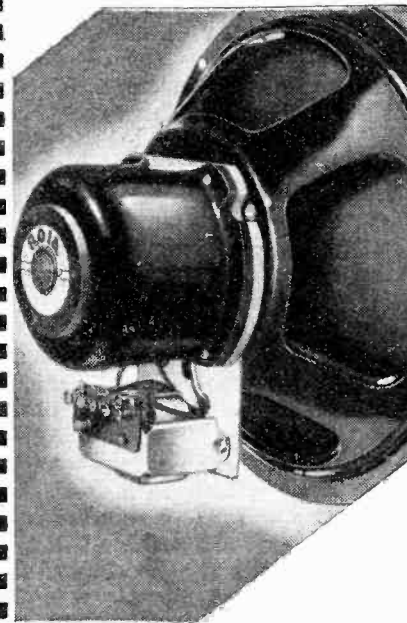

## BRINGS OUT THE BEST IN ANY RECEIVER

The best of radio receivers sounds better when equipped with a Rola G.12. There is something about its great power handling capacity, its accurate reproduction of every note, its clarity and brilliance that makes you say "this is radio reproduction such as I have never heard before." For this reason every really high-class receiver should be G.12 equipped. Probably yours is already. But if not ask your dealer to demonstrate this big 12" unit to-day. Once you have heard it you will not be surprised to learn that it is so outstanding that manufacturers' statistics prove that it "sells the set"!

- G.12 D.C. (as illustrated) Stripped, but with Transformer ... £4 4 0
  - G.12 D.C. Complete with Transformer, Mounting Stand, Handle and Base ... £5 5 0
  - G.12 D.C. with Mounting Stand, Handle and Base, but without Transformer ... £4 16 0
  - G.12 D.C. Stripped and without Transformer ... £3 15 0
  - (When ordering please state Field Resistance and Impedance of Transformer required.)
  - G.12 P.M. less Transformer ... £4 16 0
  - G.12 P.M. with Transformer ... £5 5 0
- For Public Address work both the P.M. and Energised Models can be supplied with a 15 ohm Voice Coil at an additional charge of 3/-.

Write for Folder A.

OVER 8 MILLION IN USE

# ROLA

The World's Finest Reproducers

THE BRITISH ROLA CO. LTD.  
MINERVA ROAD, PARK ROYAL, N.W.10.  
PHONE: WILLES DEN 4322-3-4-5-6.



**Components and Accessories—**

visual examination of response curves of radio receivers.

Alternatively, the oscillator can be used as a straightforward signal generator, for it has five ranges covering 90 kc/s to 20 Mc/s. A 400 c/s internal modulator is included, and provision is made for external modulation also. The price complete is £27 17s. 6d.

Important accessories such as aerial equipment will be shown by Aerialite, Belling-Lee, British Pix, Bulgin, H.M.V., K-B, Lissen, New London Electron Works and Rist.

Microphones and microphone equipment will be very prominent this year, as in the past, in view of the importance of PA as a complementary activity to radio.

Most of the firms interested in the design and development of microphones will have something new to show, and the visitor, be he PA engineer or amateur experimenter interested in this class of component, should not fail to examine the exhibits of Ardente, G.E.C., Grampian, Haynes Radio, Reslo, Shaftesbury Microphones, Sound Sales, Tannoy and Telsen.

Small but none the less important components will be shown in a wide variety of types by B.T.S., Belling-Lee, Benjamin, British Mechanical Products (Clix), British Pix, Bulgin, Hunt, W.B., Varley, Stratton and Telsen.

Stratton & Co. are specialists in short-wave equipment, and will be showing a long range of special components, many

of which will be of particular interest to short-wave transmitting experimenters. Though details of the B.T.S. products to be shown are not yet available, it is almost certain that they will have a considerable interest to the short-wave experimenter.

As most home constructors are interested in soldering, the range of Solon electric irons made by Henley's Telegraph Works and those made by the Rawlplug Co. should be inspected.

**GRAMOPHONE ACCESSORIES**

**A** NEW pick-up by Cosmocord and a record changer of new design from the Garrard factory will be shown for the first time.

The RC1A record changer will play eight 10in. or 12in. records mixed in any order, and is available with an induction motor at £10 or with a universal motor at £10 17s. 6d.

The Cosmocord pick-up is the Model 25, which is of the magnetic type. It has a short reed and is fitted with a nickel aluminium permanent magnet which reduces considerably the needle pressure on the record.

Collaro will also be showing their record changer, which deals with 9in., 10in. and 12in. records in any order, and also their record-playing units of the "letter-box" type. A wide variety of turntables and radio-gram units complete with pick-ups will also be on view.

inductance and distributed capacity with rise in temperature, series padding condensers are provided which have a negative coefficient of capacity of the correct order with increasing temperature.

The use of a Hartley type oscillator with high-"Q" coils and a low-inductance-to-capacity ratio, results in reducing the frequency drift due to power-line changes.

It is also necessary to use high-grade moulded condensers and resistances.

The main tuning condenser is, of course, of a special type, incorporating a small 15 mmfd variable section for the band-spread circuits. It appears that the band-spread facility is provided in addition to an all-wave coverage down to 13 metres.

To turn now to reception conditions. On Wednesday, July 28th, conditions seemed excellent, W2XAD in particular being splendid at 11.30 p.m. and W3XAL fair. Between 11.30 p.m. and midnight, Wednesday, W2XE on 11.38 Mc/s was relaying a Columbia programme from the studios of KNX, Los Angeles, which was of the Café Colette type, featuring songs of various countries.

When it came to England's turn I was pleased to hear "On the Road to Mandalay" announced, but, unfortunately, a very Americanised version was given, omitting all reference to "Come you—British Soldier" and the buses which do not run to Mandalay. Please, KNX, do not forget your short-wave audience.

Early Saturday afternoon, July 31st, W2XE was often excellent on 21 Mc/s—but spoilt from the point of view of programme reception by deep fading. Later, in the early evening, conditions from the U.S. were poor, but W3XAL finally reached excellent on 17.78 Mc/s by 9.55 p.m. Tokyo JZK was excellent on 15.16 Mc/s at this time, apart from a weak 5 kc/s heterodyne.

Monday evening, August 2nd, was outstanding for the excellent U/H.F. conditions round about 9 p.m.

The Italian IBT (second harmonic) was a colossal signal on 40 Mc/s (approx.) at 8.50 p.m., and nearby a station, presumably a marker beacon on some distant aerodrome, was sending out "RRR" continuously at R7/9. Weak television signals (vision) were also heard for a few minutes around 43 Mc/s.

The outstanding signal, however, was a French duplex telephone transmitter, also on 43 Mc/s approx., using speech-operated carrier-suppression. Colossal signals were obtained with only slight fading over a long period. Was this the French circuit to Corsica? Opinions or further information would be welcome.

Late on Monday evening very strong telegraphic signals were intercepted from the S. Americans around 20 Mc/s, such as LSE, Buenos Aires, and PPX, Rio.

Commentaries on the America's Cup were also best received from W3XAL at 9.23 p.m., W2XE being next best.

At 10 p.m. Monday evening JZK was again good, programme, news in English; OLR was also very strong in the 11 Mc/s band, also broadcasting English news at this time.

To me it seems illogical that the Japanese should build a short-wave station for dissemination of news and culture to their nationals and foreigners outside of Japan, when at the same time foreigners resident in Japan are not allowed to possess or operate a short-wave set.

Surely, what is sauce for the goose is sauce for the gander.

ETHACOMBER.

## On The Short Waves

**A**LL readers will be familiar with the broad principles of band-spread tuning, and therefore the following extract from the *R.C.A. Review* for July, 1937, should be of more than passing interest.

Writing on "New Features in Broadcast Receiver Design," four R.C.A. engineers state, after a reference to the strong and consistent European short-wave signals heard in the U.S.A., that "Many of the 1938 receivers incorporate a type of electrical band spread which brings to the customer the four principal short-wave bands with greater ease of tuning than for the standard broadcast band.

"Short-wave stations are spaced over 50 times farther apart on the dial than on former short-wave receivers.

"The principal station names are printed directly on the dial, together with their respective *megacycle* marking.

"The customer (I love this word) merely turns the dial pointer to the station name and then accurately tunes his receiver by the maximum deflection of the tuning indicator. Each of these four bands is approximately 280 kilocycles in width and occupies a space on the dial about 10in. in length.

"The exact ranges are as follows:—

49 metre band :	5.97-6.24 Mc/s,	width 270 kc/s.
31 " "	9.41-9.69 " "	280 " "
25 " "	11.68-11.92 " "	240 " "
19 " "	15.09-15.38 " "	290 " "

"The 16- and 13-metre bands are not included on the band-spread scales, since these

bands are of lesser importance to listeners in this country.

"These higher frequencies are only suitable for daylight transmission and reception over very long distances."

It appears with this pronouncement that a big step forward has been taken in the production of foolproof short-wave receivers.

After explaining some of the circuit details the authors go on to say: "One of the most serious difficulties to overcome in the design of such a band-spread system is due to frequency drift of the oscillator circuits caused by changes in humidity and temperature. Since each spread-band range is calibrated in station names, and also in 10-kilocycle divisions spaced over  $\frac{1}{4}$ in. apart, it becomes of greatest importance that oscillator drift be reduced to a minimum."

Many listeners have probably noted that as a superhet all-wave receiver warms up the oscillator frequency becomes lower, so that in order to hold the desired station it is necessary to rotate the dial or pointer towards the higher frequency end of the scale.

This effect was so marked in some receivers used in India a year or so ago that 21 Mc/s stations, such as GSH (on 13.97 metres) gradually passed out of the tuning range of these particular receivers (the 21 Mc/s band being located at the extreme end of the tuning scale) as they warmed up.

In the new receivers, in order to compensate for this drift to a lower oscillator frequency as a result of an increase in coil



# The Wireless World

THE  
PRACTICAL RADIO  
JOURNAL  
27<sup>th</sup> Year of Publication

No. 939.

FRIDAY, AUGUST 27TH, 1937.

VOL. XLI.

No. 9.

Proprietors: ILIFFE & SONS LTD.

Editor:  
HUGH S. POCOCK.

Editorial,  
Advertising and Publishing Offices:  
DORSET HOUSE, STAMFORD STREET,  
LONDON, S.E.1.

Telephone: Waterloo 3333 (50 lines).  
Telegrams: "Ethaworld, Sedist, Lounon."

COVENTRY: Hertford Street.

Telegrams: "Autocar, Coventry."  
Telephone: 5210 Coventry.

BIRMINGHAM:

Guildhall Buildings, Navigation Street, 2.  
Telegrams: "Autopress, Birmingham."  
Telephone: 2971 Midland (4 lines).

MANCHESTER: 260, Deansgate, 3.

Telegrams: "Iliffe, Manchester."  
Telephone: Blackfriars 4412 (4 lines).

GLASGOW: 26B, Renfield Street, C.2.

Telegrams: "Iliffe, Glasgow." Telephone: Central 4857.

PUBLISHED WEEKLY. ENTERED AS SECOND-CLASS MATTER AT NEW YORK, N.Y.

Subscription Rates:

Home, £1 1s. 8d.; Canada, £1 1s. 8d.; other countries, £1 3s. 10d. per annum.

*As many of the circuits and apparatus described in these pages are covered by patents, readers are advised, before making use of them, to satisfy themselves that they would not be infringing patents.*

## CONTENTS

	Page
Editorial Comment .. ..	185
Volume Expansion Problems .. ..	186
Distant Reception Notes .. ..	189
The Television Programmes .. ..	189
The Wireless World Television Receiver .. ..	190
Factory Test Gear .. ..	192
The Wireless World Straight Six .. ..	195
Random Radiations .. ..	199
Notes and News .. ..	200
Listeners' Guide for the Week .. ..	201
Broadcast Brevities .. ..	202
In Search of Radio Shows .. ..	203
Guide to Stands at Olympia .. ..	204
Recent Inventions .. ..	206
Olympia Show Report .. ..	207



## The Show Opens

IT is proper that each Radio Show year by year should impress the visitor that it is much better than any of its predecessors. One or two of the shows in the past few years have almost failed to come up to such expectations, but our early inspection of Olympia, 1937, convinces us that this year is of more than usual interest in a number of respects.

The first impression upon entering the Hall is that the general appearance of the Exhibition is far more varied than in past years. This impression is not mere fancy; it is because, whereas in past years exhibitors have been required to design their stands to observe a certain uniformity in style, licence has been given by the organisers this year to build their stands individually without such restrictions. The result is, naturally, a much more varied general effect.

The apparatus exhibited also gives the impression, which closer inspection confirms, that manufacturers have shown more independence in their new designs this year with less standardisation of types and greater variety both in product and price.

The arrangements for viewing television are a very great improvement on the facili-

ties given last year; there is accommodation this time for far more people to attend the demonstrations, which are more numerous and conducted under far more satisfactory conditions. The decision as to whether or not television demonstrations should be given at all was postponed until the eleventh hour last year, and arrangements were eventually carried through so hastily that it could not be expected that the facilities would be satisfactory. These difficulties have not arisen this time, and we do not think that there can be complaints regarding opportunities now offered for television viewing.

The Museum, which this year is an innovation, is an excellent idea. Unfortunately, it was not until rather a late date that the plans for such an exhibit were laid, and, in consequence, it has not been possible to arrange for the exhibits to be a well-balanced record of the development of wireless. We trust that a Museum will form a permanent feature of radio shows of the future.

We hope that our present issue will provide a useful guide to the exhibits, a more detailed consideration of which, from the point of view of new developments and outstanding technical interest, will be given next week.

# Volume

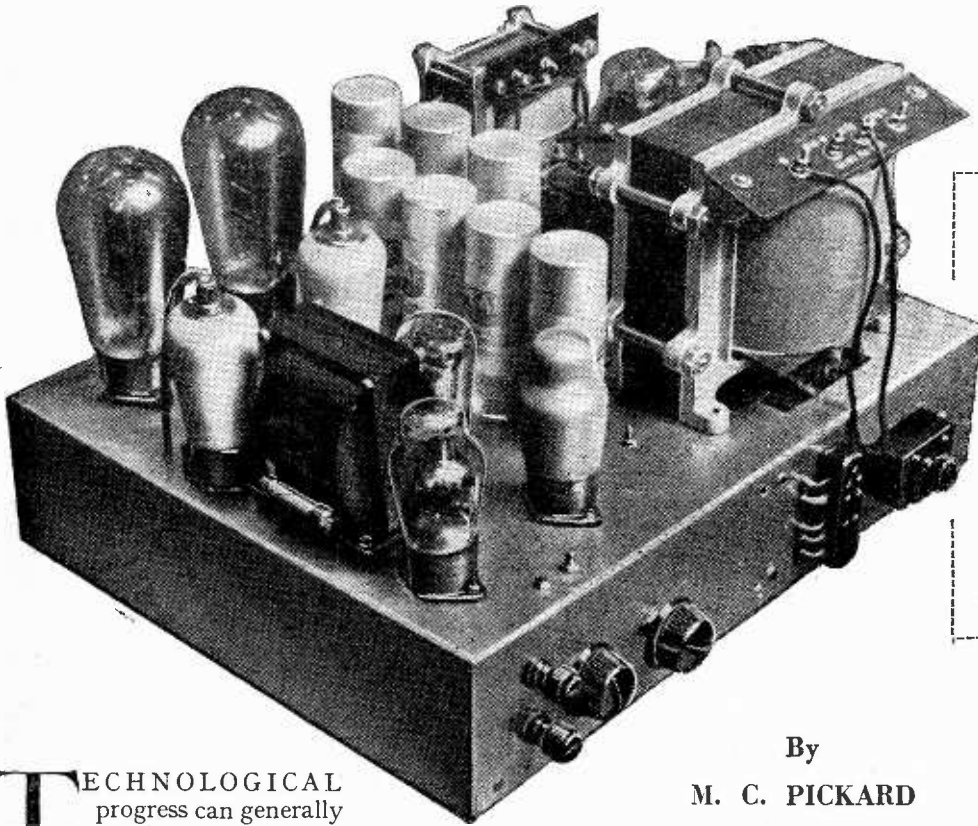

*If realism is to be regarded as the ultimate aim in broadcast reproduction, some form of volume expansion (or contrast amplification) is essential for restoring the original contrasts between loud and soft passages which are necessarily reduced by the control engineer. The author of this article discusses the various problems associated with the restoration of contrasts and describes a new circuit arrangement for achieving this object.*

By  
**M. C. PICKARD**

**T**ECHNOLOGICAL progress can generally be judged by two standards, the technical and the æsthetic. This is so much the case with volume expansion that I am going to start at what was the last stage of my experimental investigation and ask: Is it worth while? But I am not going to answer my own question directly. The considerations I shall put to you will enable you to draw your own conclusions, and I to escape the calumny of those who do not agree with my personal opinion.

The object of volume expansion is, ideally, to counteract the limitation set by the control engineer to the range of contrast between loud and soft when an orchestral work is being recorded or broadcast. If we seek realism this aim is evidently fully justified. Present conditions are, however, against its being achieved, for the control at the transmitting end is arbitrary; its precise functioning cannot be predicted; what is put back cannot, except by a fluke, correspond with what was taken out. Thus it is not at present in our power to realise the ideal of expansion with the recordings and transmissions we are accustomed to; and so nothing can be said finally one way or the other about its artistic merit. But this defect is not basic; and when once an automatic modulation-depth control is adopted, and its characteristic published, it will be possible to construct an expanding receiver that really fulfils its theoretical purpose.

In the meantime what is accomplished is a sort of synthetic hotting-up of everything being received, with the degree of hotting under the control of the operator. The result of expansion in such circumstances depends very much upon the type of programme being handled, the discretion of the man in charge of the hotting control, and the taste of the listener.

So much for the æsthetics of the problem. Having cautiously introduced the subject and built up a sufficient defence against any outraged æsthetist, I can proceed to the more simple matter of discussing how a volume-expanding amplifier may be designed to perform its function without otherwise mutilating the reproduction.

The problem is, of course, that of AVC at audio-frequency. But there is this profoundly important difference: with radio-frequency AVC no attempt is made to make the control-voltage follow the modulation-envelope of the wave being

two, since there are, in fact, two quite separate objects to be realised. The first is the provision of a valve amplifying circuit in which the degree of amplification can be made to vary by altering a potential difference applied to some part of it. The second is the derivation of such a "control-potential" from the signal being amplified, its magnitude to be proportional to the width of the envelope of the signal.

Any variable- $\mu$  valve can be made to perform function No. 1, but the type of valve in which this end is achieved by varying the bias on a control-grid whose influence on the plate current is a function of the impressed voltage cannot be used because it introduces amplitude-distortion of the signal. This rules out the ordinary variable- $\mu$  tetrodes and pentodes for our purpose. Fortunately, there remains an entirely different type of variable- $\mu$  valve which does not suffer

from this defect of introducing amplitude-distortion. The valve in question has two control-grids, each of which possesses the normal linear controlling influence on the plate current; these two grids are separated by an intervening electrostatic screening electrode which

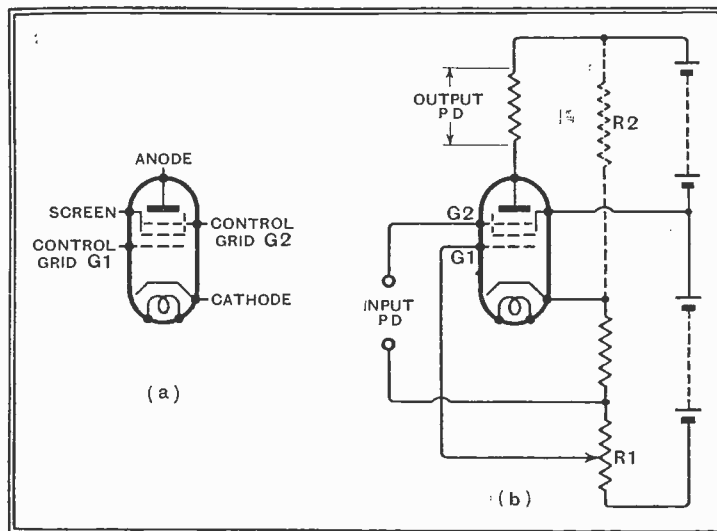

for simple amplification.

controlled—in fact, we take special precautions to prevent its occurring—but in volume expansion it is the shape of the audio-frequency "envelope" that is made to exercise the control. That is an important fact to grasp.

The next step is to split the problem in

prevents the potential of either control-grid from having any influence in the space in which the other exercises its control. Such a valve in its simplest form is shown diagrammatically in Fig. 1 (a),

# Expansion Problems—AND

## A PRACTICAL CONTROLLING SYSTEM

and its circuit connections as a simple amplifier are shown alongside at Fig. 1 (b). The type equation of such a valve is  $I_p = (A + Be^e)(P + Qe^e)$ , where  $I_p$  is the plate current,  $e^e$  the potential of grid  $G_1$ ,

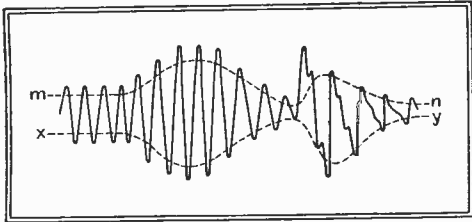

Fig. 2.—Voltage wave of constant frequency but varying amplitude and its envelope.

$e^e$  that of grid  $G_2$ , and  $A, B, P, Q$  are arbitrary constants. Thus, if  $I_p$  is plotted against  $e^e$  for different values of  $e^e$ , a series of straight lines is obtained, all cutting the  $e^e$  axis at the same point but having different slopes. Making  $G_1$  more negative consequently reduces the mutual conductance of the valve with respect to its other grid  $G_2$ , but does not affect the magnitude of the permissible alternating signal-voltage that may be applied to  $G_2$  for a given degree of amplitude distortion.

### Suitable Valve Types

This class of valve includes the ordinary heptodes and octodes and some pentodes. In the original experiments octodes were used with fair success, but the Mazda AC/SP1 screened pentode was finally adopted as most satisfactory.

A consideration of Fig. 1 (b) shows that the value of the standing cathode current depends upon the value of the voltage impressed on  $G_1$ , so that altering the position of the variable contact on  $R_1$  to give a change of gain will also alter the grid bias developed in the cathode resistors. In a practical amplifying circuit of this nature provision has consequently to be made to keep the PD across these resistors constant. An obvious way of doing this is to swamp the normal cathode-current by a much larger current taken direct from the HT source through a suitable resistance  $R_2$ , shown in dotted lines; in this way the effect of changes in cathode current can be made negligible. There is a simpler way out of the difficulty, however; if the gain-control voltage is applied to  $G_2$  instead of  $G_1$ , then the cathode current is determined by the combined potentials on the screen and  $G_1$ , which is now the signal-grid, and these potentials are constant under working conditions. The effect of altering the "gain-potential" on

$G_2$  is now only to change the current flowing to the plate, the cathode current remaining unaltered and equal to the sum of the screen and plate currents. For this reason  $G_2$  and not  $G_1$  is used in practice as the gain-control grid.

Since the potential of  $G_2$  must not in operation become high enough to allow grid current to flow, the first half of the problem resolves itself into providing  $G_2$  with a moderately large initial negative bias, and deriving from the signal a "gain-control" potential which can be applied to  $G_2$  with such polarity as will offset the effect of this negative bias.

To gain some idea of the next part of the problem consider Fig. 2. This diagram represents a voltage wave of constant frequency but variable amplitude. The dotted lines  $mn, xy$  show the envelope of such a wave, and the problem is to extract from the alternating voltage the wave represents a unidirectional voltage following the mean contour of the envelope, the

up to a point. But some further considerations have also to be taken into account. The difference between the lowest frequencies of the wave and the highest effective frequency occurring in the envelope is comparatively small. Suppose the wave shown to have a frequency of 1,000 c/s; then the highest envelope frequency could be taken as about 250 c/s. Hence a low-pass filter designed for a cut-off frequency of, say, 700 c/s would, for our illustrative case, be satisfactory. But 1,000 c/s is not the lowest frequency we shall encounter in amplifying the voltages produced by a musical programme; suppose, for instance, we had to amplify a voltage wave as shown in Fig. 2, but having a frequency of 100 c/s. The low-pass filter chosen for the first case will not satisfy the second; it would allow some frequencies corresponding to the signal, but badly distorted through being rectified, to be impressed on the gain-control grid of the expanding pentode, in addition to the required envelope frequencies. This would naturally produce an undesirable effect in the reproduction, the extraneous frequencies introduced resembling the harmonics produced by amplitude distortion. Moreover, a low-pass filter designed to have a low enough cut-off to cope with the 100-c/s wave would prevent the more rapid variations of the 1,000-c/s wave being faithfully followed. Would this matter?

Fortunately in this respect the problem is psychological, the criterion of technical success being what the ear will tolerate. In practical reproduction, though the initial rate of change of envelope width may be high in musical "attack," the new value is invariably maintained over at least a considerable fraction of a second. From this fact the secondary problem emerges of what lag in the response of the apparatus the ear will tolerate when a constant signal is suddenly raised to a higher level of loudness. Experiments showed that a

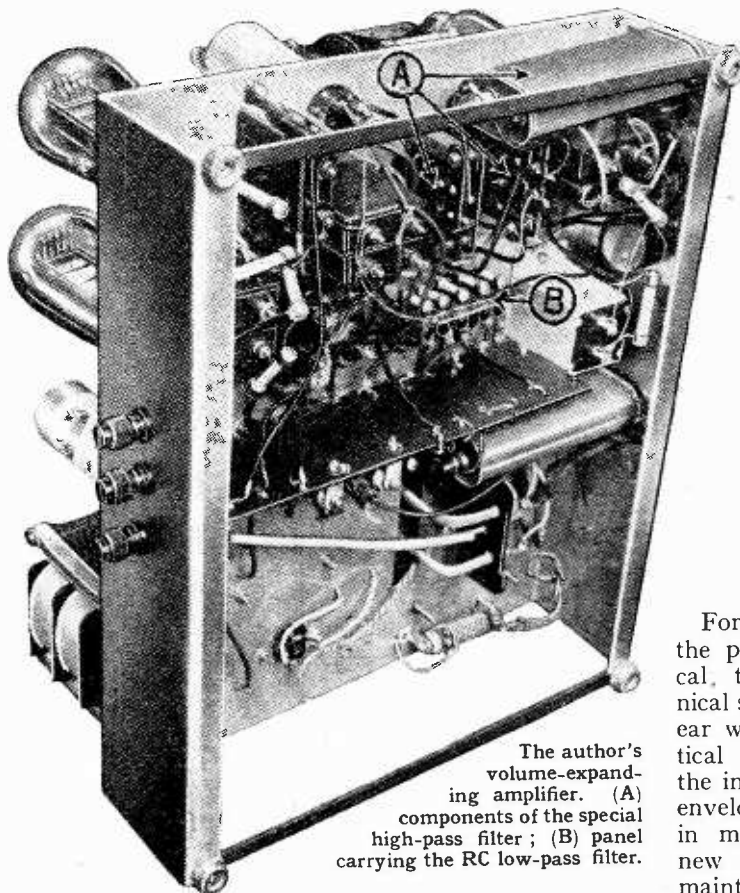

The author's volume-expanding amplifier. (A) components of the special high-pass filter; (B) panel carrying the RC low-pass filter.

two sides of which are not necessarily symmetrical. Full-wave rectification followed by a low-pass filter that will pass the frequencies represented in the envelope contours, but reject the higher frequencies of the wave itself, satisfies the requirements

**Volume Expansion Problems—**

lag of 1/100 second was allowable; the ear does not require that the more rapid changes in envelope contour should be followed with exactitude.

The requirements of the circuits for extracting the gain-control potential can now be stated with some precision. First, the unidirectional voltage produced must have a magnitude that varies as the mean contour of the signal envelope; secondly, this variation need not keep perfect time with the more rapid amplitude changes, but can take 1/100 second (at most) to adjust itself to an instantaneous change of envelope width; thirdly, the gain-control potential must be free from any frequency component corresponding to the frequencies of the wave itself.

**Practical Solutions**

The first of these requirements is satisfied by a full-wave rectifier; but such a rectifier, if it drew power from the signal source, would in practice create distortion due to its impedance not remaining constant during the cycle. Consequently, it must be isolated from the source by a "buffer" valve. A low-pass filter or its equivalent interposed between the rectifier output and the gain-control grid of the pentode ensures that the third condition laid down shall be satisfied; to satisfy condition No. 2 this filter must cut off at a frequency not less than 100 c/s. Consequently, to ensure that no lower frequency than 100 c/s shall be present in the rectifier output, a filter of the high-pass variety must be interposed between the buffer valve and the rectifier. Since the full-wave rectifier produces in its output no lower frequency than double its lowest input frequency, this high-pass filter should cut off at a little more than one-half the cut-off of the low-pass filter; in the case we are considering at about 60 c/s.

What happens to frequencies of less

severely—in fact, make it function as an anode-bend rectifier—in which way it will be made to produce plentiful harmonics and in particular a strong second harmonic. By this means, retaining the 60-c/s cut-off for the high-pass filter, fre-

L3. The mean value of the load is calculated roughly as follows: Let P be the potential created across the reservoir condenser C by an alternating voltage E in L3. Then  $P^2/R$  is the power dissipated in the gridleak R, and assuming that R is

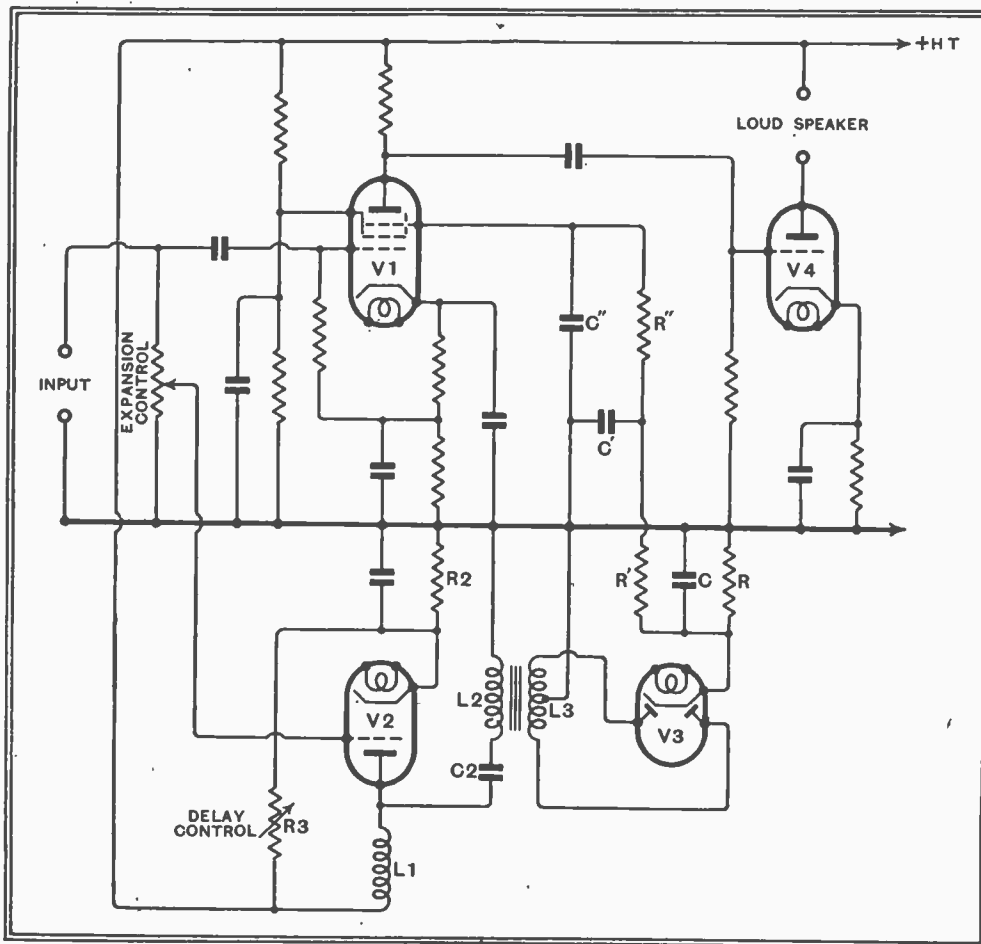

Fig. 4.—The complete volume-expanding system.

frequencies down to 30 c/s are enabled to produce the desired expansion effects.

Having collected all the necessary material we are now able to put it to practical use. In Fig. 3 the circuit is shown for obtaining the gain-control potential in accordance with the regulations laid down. V1 is the buffer valve, biased by means of the cathode resistor R2, parallel-fed through R3 from the HT supply. For normal operation R3 will be adjusted so that the plate current is about 1/2 mA. If delayed expansion is required, the bias can be increased by the amount of the selected delay voltage by reducing R3. L1, C2, L2 form a simple

very high compared with the valve impedance,  $P^2/R = E^2/Z$ , where Z is the effective impedance of the rectifier and its associated circuits. But we may assume  $P = E \sqrt{2}$ ; therefore,  $P^2/R = 2 \cdot E^2/R = E^2/Z$ , whence  $Z = R/2$ . This impedance  $R/2$  is coupled inductively to L2, and its equivalent value in parallel with L2 may be roughly assessed by ordinary transformer methods; that is  $Z' = R/2n^2$ , where Z' is the equivalent resistance across L2 and n is the turns ratio of L3 to L2. Thus, by using a 5 or 6 to 1 step-up between L2 and L3, Z' can be brought low enough (R being about 100,000 ohms) to make possible the efficient design of the high-pass filter L1, C2, L2.

The simple resistance-capacity low-pass filter shown on the right of the diagram was chosen because of the difficulty of designing a more advanced type of work with a high load-resistance, and in practice it has proved entirely satisfactory.

For the sake of completeness a circuit diagram of the entire system in one of the many forms it may take is shown in Fig. 4. The circuit shown has one minor disadvantage; assuming a high efficiency of the coupling between valves V1 and V4 at low frequencies, the operation of the expansion system can, in certain circumstances, produce a low-periodicity "flut-

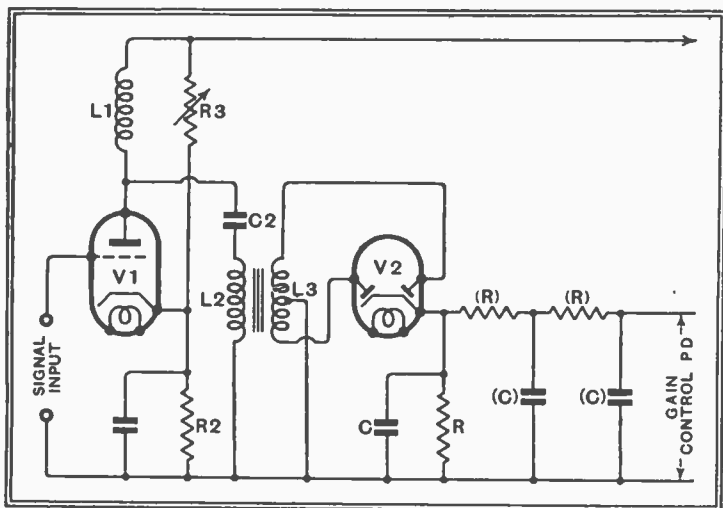

Fig. 3.—Circuit for providing the gain control potential.

than 60 c/s in the signal? As matters stand, these can produce no expansion, since they are prevented from actuating the rectifier. A way out of the difficulty is to overbias the grid of the buffer valve

π-type high-pass filter, the elements being calculated to cut off at about 60 c/s. The values must be chosen to match the load, which is the rectifier V2 and its associated circuits coupled to L2 through



**Volume Expansion Problems—**

ter" of the speaker diaphragm. To overcome this defect a push-pull circuit has been used very successfully; two AC/SP1 pentodes have their signal-grids fed in phase opposition, their gain-control grids being operated, of course, in the same phase. These two valves are coupled separately to a pair of output valves the plate circuits of which are in phase opposition. Hence any unwanted effects introduced at the gain-control grids are cancelled in the output circuit of the power valves.

And now to sum up. The scheme has been developed as a result of about nine

months' work in the laboratory from crude beginnings. In its present form its success is beyond question in its purely technical aspects; its æsthetic success, as I pointed out at the beginning of this article, is largely a matter of circumstance. On some recordings and with some transmissions it appears to enhance the realism of the reproduction, on others not. I have little doubt personally that the adoption of an automatic system of control by the B.B.C., allowing of the use of expansion at the receiving end with immunity from the erratic consequences that sometimes attend its use to-day, would be a great advance on present practice.

version of this set, covering waves between 8 and 70 metres in three ranges, has two extra valves.

## Television Programmes

**For the convenience of visitors to the Radio Exhibition the afternoon and evening television programmes during the Show will be divided into three sections with short intervals between them.**  
Vision 45 Mc/s. Sound 41.5 Mc/s

FRIDAY, AUGUST 27th.

**11.30 a.m.—12.30**, Special demonstration film.

**4, 4.20 and 4.45**, O.B. from the Pets' Corner Regent's Park Zoo.

**4.5 and 4.50**, Margot Fonteyn (Ballerina) and Lisa Minghetti (violin). **4.25**, Television Follies, with Vera Lennox, Pat Denny, Richard Murdock and Michael North.

**9 and 9.40**, Margot Fonteyn and Lisa Minghetti. **9.10**, British Movietonews. **9.20**, Television Follies. **9.50**, Film, "Touchdown Mickey."

SATURDAY, AUGUST 28th.

**11 a.m.—12.30**, Special demonstration film.

**4 and 4.45**, In Our Garden; practical talks on gardening by C. H. Middleton from the grounds of Alexandra Palace. **4.5 and 4.50**, Ernest Mills, cartoons. **4.10 and 4.45**, Edward Cooper in songs at the piano. **4.20**, O.B. from the Pets' Corner. **4.25**, Variety with Charlie Higgins (comedian), Ernest Shannon in impressions and the Bavera Trio, skating sensation. **9 and 9.40**, Ernest Mills. **9.5 and 9.45**, Edward Cooper. **9.10**, Gaumont-British News. **9.20**, Variety. **9.50**, Film, "Mad Doctor."

MONDAY, AUGUST 30th.

**11.30 a.m.—12.30**, Special demonstration film.

**4, 4.20 and 4.45**, O.B. from the Pet's Corner. **4.5 and 4.50**, Eric Wild and his Tea Timers. **4.25**, Tommy Handley and Company in Eric Blore's war-time musical sketch "The Disorderly Room."

**9 and 9.40**, Eric Wild and his Tea Timers. **9.10**, British Movietonews. **9.20**, "The Disorderly Room." **9.50**, Film, "Mickey's Mellerdrummer."

TUESDAY, AUGUST 31st.

**11.30 a.m.—12.30**, Special demonstration film.

**4 and 4.25**, Marine models on the lake in the grounds of Alexandra Palace. **4.5, 4.25 and 4.50**, Henry Hall and his dance orchestra. **4.20**, O.B. from the Pet's Corner.

**9 and 9.40**, Anne de Nye. **9.5 and 9.45**, Arthur Prince and Jim. **9.10**, Gaumont-British News. **9.20**, Joan Collier in songs, accompanied by the Television Orchestra.

WEDNESDAY, SEPTEMBER 1st.

**11.30 a.m.—12.30**, Special demonstration film.

**4, 4.20 and 4.45**, O.B. from the Pet's Corner. **4.5 and 4.50**, Elizabeth French in songs. **4.10 and 4.55**, Wendy Toye in dances. **4.25**, Seventy-third edition of "Picture Page."

**9 and 9.40**, Elizabeth French. **9.5 and 9.45**, Wendy Toye. **9.10**, British Movietonews. **9.20**, Seventy-fourth edition of "Picture Page." **9.50**, Film, "Mickey's Good Deed."

THURSDAY, SEPTEMBER 2nd.

**11.30 a.m.—12.30**, Special demonstration film.

**4 and 4.45**, Fire up Aloft. Demonstration of fire-fighting with a 90-foot all-steel turntable escape. **4.5 and 4.50**, Ballroom dancing, demonstrated by Alex Moore and Pat Kilpatrick. **4.20**, O.B. from the Pet's Corner. **4.25**, "Coffee Stall" (No. 4); a light entertainment.

**9 and 9.40**, Phyllis Robbins. **9.5 and 9.45**, Cyril Fletcher in comedy. **9.10**, Gaumont-British News. **9.20**, "Coffee Stall" (No. 4). **9.50**, Film, "Mickey's Mellerdrummer."

## DISTANT RECEPTION NOTES

### Where the Home Stations Are "D.X."!

IT'S always a most interesting experience to try long-distance reception in an entirely new locality. My home is in Hertfordshire, at a place where the field-strength of distant stations on long, medium and short wavelengths is particularly good; just how good I never realised until a year or two ago, when I began to take one of my own receiving sets with me, wherever I went for a holiday. One knows, of course, exactly what one's set will do under normal conditions on its native heath. In a recent instalment of these notes I recorded the results of an evening spent at home in exploring the "broadcast" band between 200 and 550 metres. The total number of foreign stations received, you may recall, was 40, of which 28 were classed as giving excellent reception and 12 pretty good reception. In addition, I can hear the London, North, Midland, Welsh, West and Northern Ireland Regionals and the London National well on any evening.

For the last few weeks I have been using the same set in a very different part of the world: a Cornish village on Mount's Bay, nearly 300 miles west of my home. The difference in the results obtained is really startling.

Reception in this part of Cornwall is in any case not easy, for the mains AC is so "rough" that even with an interference eliminator of a type that is usually most effective, mains-borne background noisiness is a great nuisance. Mains-borne it is unquestionably, for the house that I am occupying stands all by itself. Traffic on the lane running past it does not average more than three or four cars an hour at the outside, and there is no kind of electrical machinery within a quarter of a mile or more.

### Bad Reception from Droitwich

The first discovery I made was that in the daytime not one of the home stations could be relied upon for respectable reception! West is the best of a bad lot; Droitwich is very poor. After dusk Northern Ireland comes in fairly well. It's a curious experience to have to indulge in DX in order to get the news bulletins from the home stations.

More curious still—and rather humiliating—to find that many of the Continental stations come in better after dusk than those in one's own country. But so it is.

Foreign stations from which I can obtain good volume and reasonably good quality are Radio Méditerranée, Radió Marconi (Bologna), Bordeaux-Lafayette, Hilversum No. 2, Breslau, Radio-Toulouse, Hamburg, Toulouse P.T.T., Munich, Paris P.T.T., Cologne, Lyons P.T.T. and Athlone—though Athlone is hardly a foreign station, except that it's not B.B.C.

It would seem, then, that those who live in this part of the country are normally rather better served by France, Holland, Germany and Italy than by our own stations. The opening of the new B.B.C. Regional station near Start Point should make a considerable difference to folk in the extreme South-West of England; but so long as Droitwich serves them none too well they will not have good reception of the National programmes.

Meantime, those who dwell here are, willy-nilly, DX'ers whenever they use their wireless sets. It is rather queer as you pass this cottage or that to hear French or German programmes issuing from its open windows. Queer, too, to find your own reception not infrequently interrupted by the up-and-down-the-scale catcalls radiated by users of small sets, who have to work them on the verge of oscillation to obtain news or entertainment at reasonable volume from their home stations. D. EXER.

## Chassis or Cabinet Set

### A Flexible Arrangement

ANY one of the six chassis now being produced by Halford Radio, of 31, George Street, Hanover Square, London, W.1, can be supplied without a cabinet, or can be fitted into any style of cabinet to the choice of the purchaser.

A feature of the larger Halford models is what is described as "twin circuit control"; the superheterodyne and "straight" principles are combined in the one chassis, the change-over being effected by manipulation of a simple switch. Naturally, the "straight" circuit is used for short-distance work when the best possible quality of reproduction can be realised.

One of the models in which this method is employed has a nine-valve chassis giving 6 watts from a push-pull output stage. The total number of tuned circuits reaches the exceptionally high figure of 15. An all-wave

The Wireless World

# Television Receiver

A BRIEF  
DESCRIPTION OF  
THE EQUIPMENT  
DESIGNED AND  
BUILT IN OUR OWN  
LABORATORY

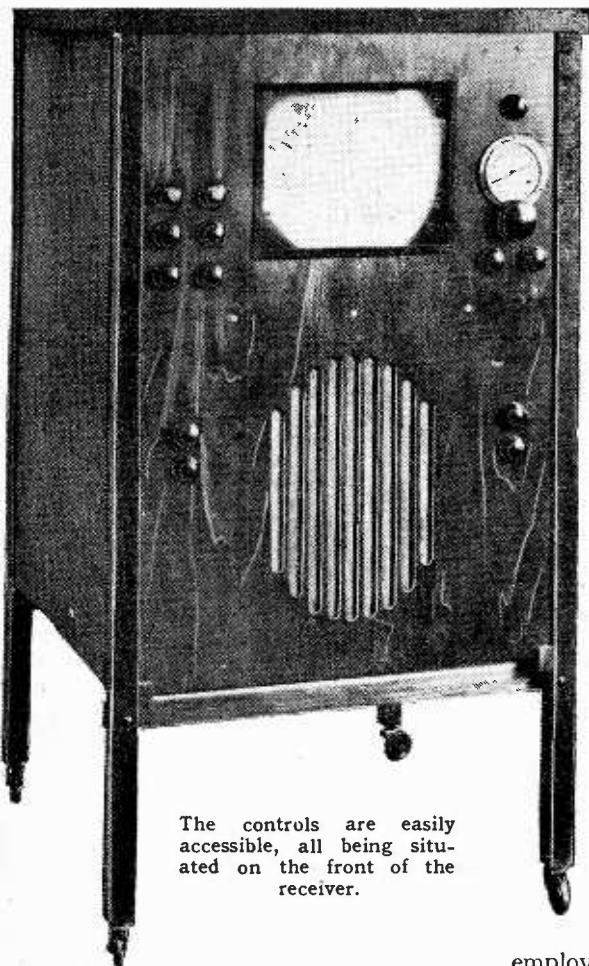

The controls are easily accessible, all being situated on the front of the receiver.

**F**OLLOWING a series of theoretical articles on the design of television equipment, full constructional details were given in the issues of *The Wireless World* dated July 2nd, 9th, 16th, 23rd, and 30th, 1937, of a complete television receiver. Since the conclusion of the design the apparatus has been in regular use, and proved itself to be both reliable and efficient, and, furthermore, to be sufficiently simple in its controls for the non-technical to handle with ease.

The equipment really consists of two entirely separate receivers—one for sound and the other for vision. The sound receiver is a straight set, built in two units. One RF stage is employed with two tuned circuits and a reacting grid detector; this valve is followed by a triode AF amplifier resistance-coupled to a triode output valve which delivers some 2.5 watts to the high-quality permanent-magnet speaker. The mains equipment is simple, and includes a full-wave rectifier. Including this rectifier, there are thus five valves in the sound receiving equipment.

The vision receiver is also a straight set, since experience shows it to be simpler to adjust than the superheterodyne. This latter type of receiver is very liable to special forms of interference in vision reception, and requires very precise adjustment if it is to give as good a performance.

Owing to the large band-width required for good picture definition, some 4 Mc/s, the tuned circuits must be heavily damped and the gain per stage is consequently small. Three RF stages, with high-efficiency valves and four tuned circuits, are

employed, with a low-impedance diode detector and a single valve amplifier at vision frequency. The power supply is furnished by a separate unit containing a full-wave rectifier. The receiver proper thus contains only six valves.

The cathode-ray tube must have deflecting voltages applied to it in addition to the picture signal; these voltages are of sawtooth waveform and deflect the cathode-ray beam so that the raster is built up on the end of the tube. They are generated locally by the time-base, and the tube requires one voltage with a repetition frequency of 50 c/s and another with a frequency of 10,125 c/s and a total swing of about 1,000 volts.

The time-base unit thus contains two oscillators of the gas-filled triode type, each

with a balanced triode amplifier operating with an HT supply of 1,000 volts. A total of six valves is needed for generating these scanning voltages.

However well a time-base is adjusted it will not run with sufficient regularity for television purposes unless it is properly synchronised with the scanning at the transmitter. To this end sync pulses are included in the signal, and if they are to fulfil their purpose must be removed from it at the receiving end. An RF pentode is accordingly used as an amplitude filter, and separates the sync pulses from the

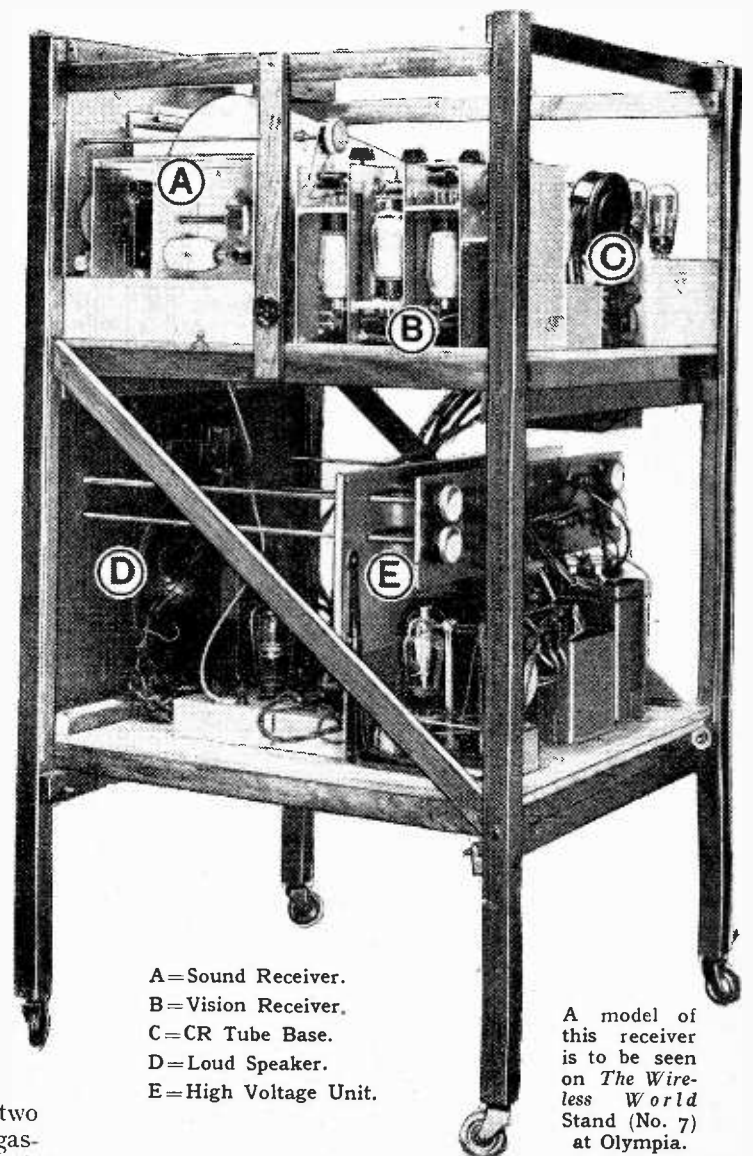

A=Sound Receiver.  
B=Vision Receiver.  
C=CR Tube Base.  
D=Loud Speaker.  
E=High Voltage Unit.

A model of this receiver is to be seen on *The Wireless World* Stand (No. 7) at Olympia.

**Television Receiver—**

vision signal so that they can control the time-base. For the correct operation of this filter it is essential that its input signal should contain the DC component which is unavoidably removed in the VF coupling. This is also desirable in the picture signal applied to the tube, and a diode is accordingly included for the purpose of replacing it.

The tube itself must have an HT supply of 4,500 volts if bright pictures are to be secured, and the time-base needs 1,000 volts. These supplies are combined, and the insulation of parts is reduced to a minimum by using two valves in the voltage-doubler circuit. A thermal delay switch is needed to safeguard components by keeping the high-voltage unit inoperative until all valves have been warmed up.

The valves used are summarised in the table below.

The cathode-ray tube is of the 12in. type, and enables a picture of about 10in. by 8in. to be obtained with a brilliancy adequate even for day-time conditions without the need for much in the way of room darkening. When used in complete darkness the brilliancy obtainable is greater than necessary, and most people prefer a duller picture. The vision receiver gain control used in conjunction with the tube bias control enables the brilliancy to be adjusted to any desired degree below the maximum.

In the design of the equipment great attention has been paid to the attainment of the desired electrical characteristics in conjunction with an easy form of construction and ready accessibility of the complete apparatus. For ease in adjustment, the time-base and HV unit controls have all been brought out to the panel, although most of them are in the nature of pre-set controls and rarely require adjustment after the initial setting.

The equipment has been found in extended tests to give reliable and consistent results with a very high standard of definition. The synchronising is good and holds well even under conditions of severe local

working towards the end of this month. It is pointed out by the B.B.C. that in the case of such a complicated piece of apparatus certain adjustments may be necessary, but Scophony have been assured that the B.B.C. will take all possible steps to ensure that the signal radiated is in such a form as to satisfy Scophony requirements.

Scophony regret that as this new Alexandra Palace equipment will not be ready in time for Radiolympia, they will be unable to demonstrate there the Scophony Home Receiver (giving a picture 24in. x 22in.) and small Public Hall Receiver (giving a picture 5ft. x 4ft.). Scophony hope, however, to be able to give public demonstrations on such receivers and to announce marketing arrangements as soon as possible after the new Alexandra Palace pulse generating equipment has been found to work satisfactorily.

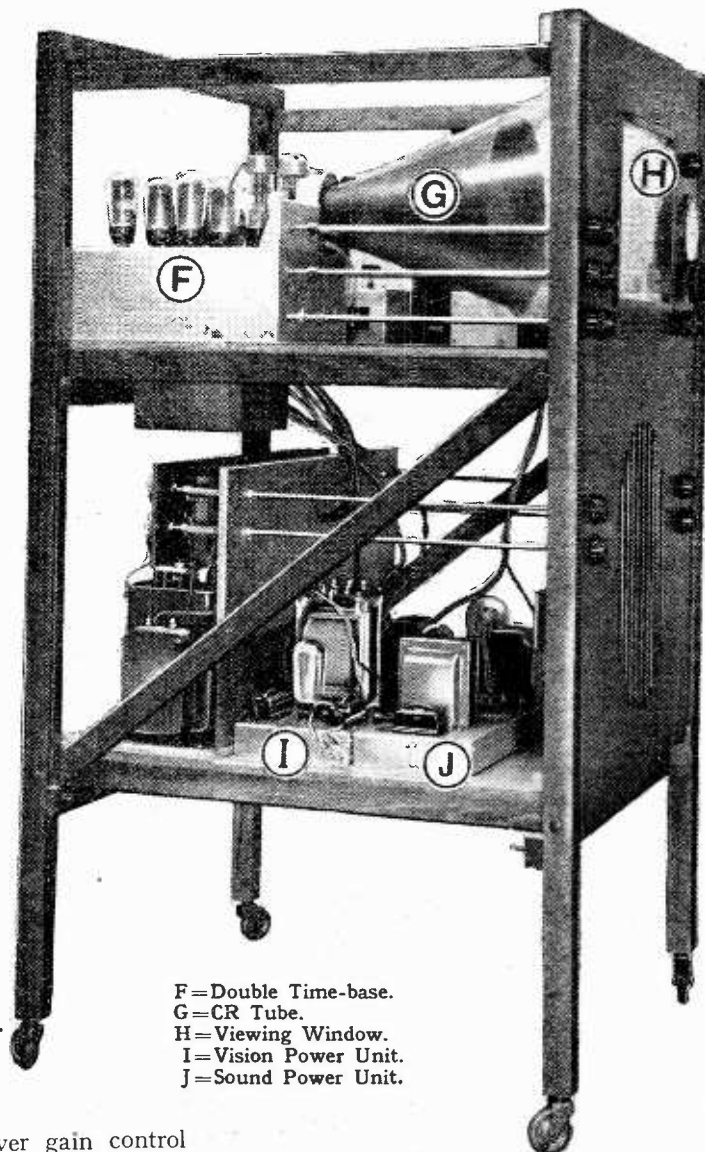

F=Double Time-base.  
G=CR Tube.  
H=Viewing Window.  
I=Vision Power Unit.  
J=Sound Power Unit.

interference, while the sound receiver gives a first-class performance.

## Scophony Television

### An Official Statement

SCOPHONY, LIMITED, recently made public the fact that, while receiving apparatus employing the Scophony methods has been designed and constructed for the reception of the present Alexandra Palace transmissions (on the 405-line standard), they have found that there was a considerable amount of irregular timing and phase shifting in the synchronising signals radiated from Alexandra Palace, which made such signals unsuitable for receivers using scanning systems possessing inertia. Representations were made early this year on the subject to the Television Advisory Committee and the B.B.C., and the B.B.C. has taken steps to remedy the defect.

The B.B.C. have now informed Scophony that a completely new pulse generating equipment is in course of construction, and will, it is anticipated, be installed and

## London National

### The B.B.C. Point of View

THE aim of the B.B.C. has been to provide all listeners living in this country who have reasonably sensitive receivers with ability to obtain alternative programmes, and it is because there are not sufficient wavelength channels allotted to broadcasting here that changes have had to be made. The B.B.C. have stated that they could not continue to spare London National wavelength channel merely to provide an auxiliary service in North London because they feel that this area is already satisfactorily served by the long-wave transmitter at Droitwich. They state that as long ago as 1933 it was announced that eventually the National programme would be radiated only by the long-wave transmitter, and this change has only been delayed until now because other developments in the service had not rendered it necessary to withdraw the auxiliary service of the National programme on medium waves entirely.

The existing arrangements, it is stated, may now be taken as permanent.

The B.B.C. insist that the National programme from Droitwich should be consistently reliable in those districts which have been taking the London National, and they claim that the quality of Droitwich transmissions is now comparable with that of the best medium-wave transmitters, and if poor quality is experienced listeners should suspect their sets.

## Ferguson Radio

### 1938 Models Announced

THE new season's receivers by Ferguson Radio, Ltd., were recently announced. These comprise sets ranging from a five-valve AC all-wave superhet at 10 guineas to 40-guinea radiograms with automatic record changer and a ten-valve radio chassis including short-wave bands and many refinements. American valves and coils are imported specially for these sets, which are designed to take advantage of many of the best features of the American-type receiver. The sets are constructed at the Chiswick works of the company.

Unit.	Valves.	Rectifiers.
Sound Receiver ... ..	4	1
Vision Receiver ... ..	5	1
Sync separation and DC restoration ... ..	2	—
Time-base ... ..	6	—
HV supply for tube and time-base ... ..	—	2
	17	4



# Factory Test Gear

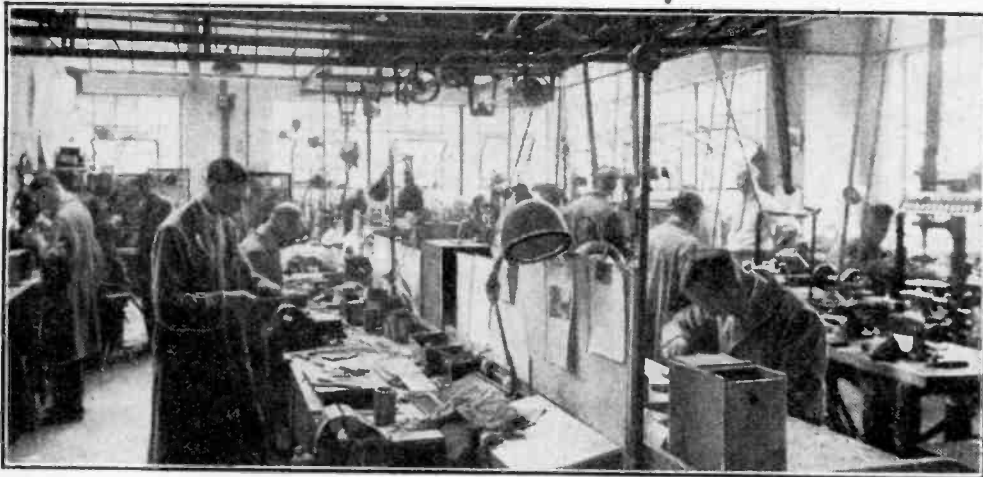

A corner of the test instrument department at the Cambridge factory of Pye, Ltd.

**T**EST methods employed by the amateur and the serviceman, although sound in principle and convenient when applied to individual receivers, would hardly suffice when the numbers run into thousands. In many cases precisely the same principles are involved in quantity production, but it would require a trained eye to detect the basic similarity between the elaborate test assemblies used on the production lines of a big factory and the compact meters which one might find, say, in the serviceman's tool-bag.

Modern factory test gear has reached its present high state of development chiefly as a result of the demand for speed, which is, of course, a significant element in the ultimate cost of the receiver to the public.

wholly occupied with its design, construction and maintenance. Some idea of the quality of the instruments produced can be obtained from the accompanying photographs, and it is no exaggeration to say that the equipment combines the precision of standardisation labora-

## Some of the Specialised Equipment Used in the Production of Pye Receivers

suitable standards. Any type of jig may be fitted for rapidly making contact to the component under test, and it is possible to arrange for rapid duplication of, say, experimental coil assemblies using the latter as a standard of comparison. In some cases complete coil units, including fixed condensers and resistances, are tested by this method, inductance being checked to  $\pm 0.5$  per cent., and the resistance and condensers to  $\pm 5$  per cent. A single indicating meter is provided, and the ratio arms are adjusted by a calibrated control with an exceptionally open scale for small deviations from zero. A power factor adjustment is provided, and the scale of this control is calibrated to read the phase angle in radians.

A modified version of one of these bridges is used to check the alignment of ganged condensers at predetermined angles of rotation, and on this instrument a direct reading capacity scale indicating to less than 0.1 micro-microfarad is included in addition to the percentage error scale. An interesting mechanical detail was noted in connection with this instrument. This was the flexible coupling between the test jig and the spindle of the condenser under examination. In order to achieve a high degree of

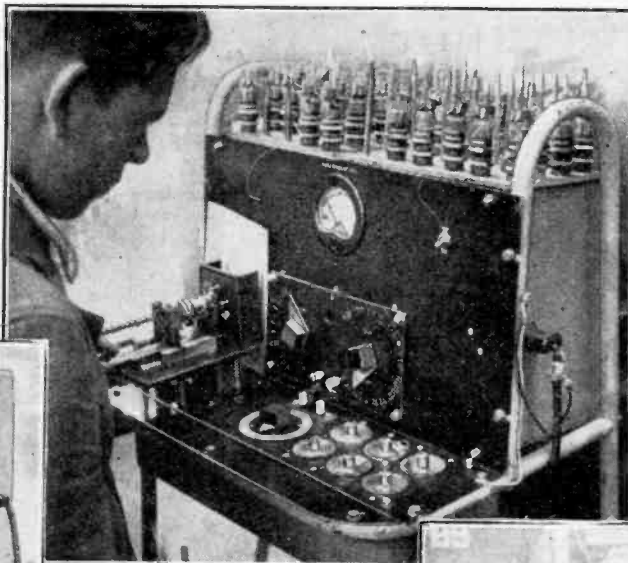

The RF impedance bridge is a versatile instrument and is shown (above) applied to the checking of coil units against sub-standards. On the left the bridge is being used to duplicate the settings of an experimental multiple coil assembly, and on the right it forms part of a gang condenser test unit.

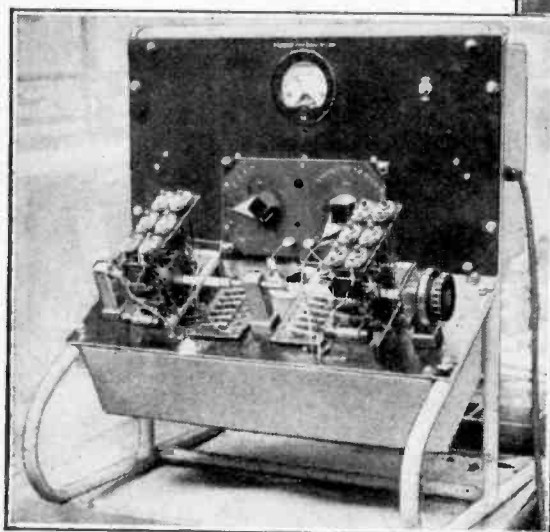

Obviously this speed must be accompanied by no deterioration of accuracy, so that the test apparatus must be strong mechanically to stand up to the wear and tear resulting from the hundreds—in some cases thousands—of operations per day.

The design of such apparatus has become the work of specialists, and in the Pye organisation two departments are

tory methods with machine tool reliability.

One of the most useful units produced by the instrument section is the RF Bridge. This is essentially an impedance-matching instrument operating usually at 1,000 kc/s. It can be used for resistance, capacity or inductance measurements against

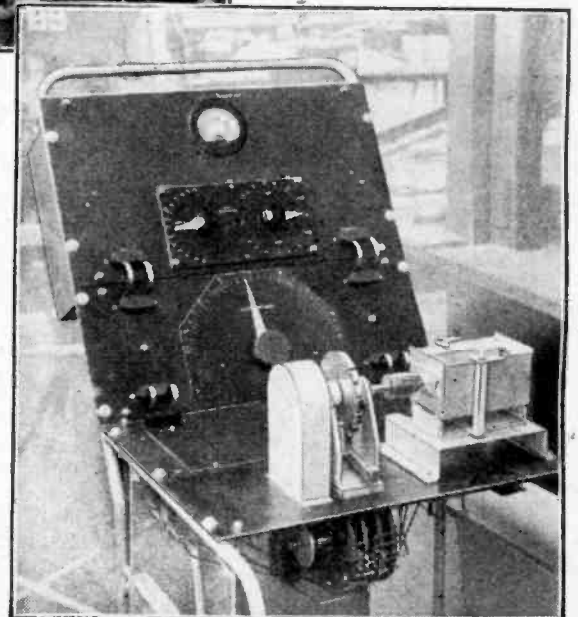

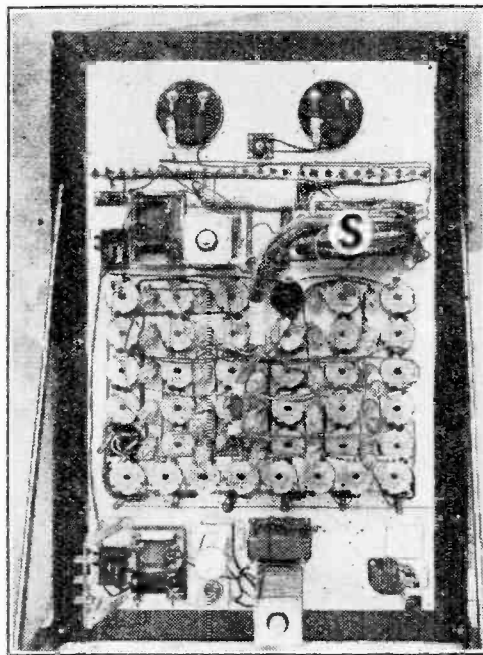
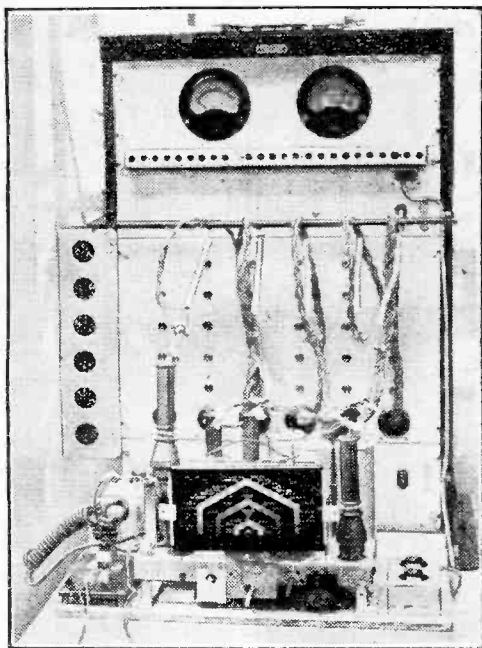

Automatic "volts and continuity" test panel. A telephone selector switch (S) runs through the tests in a given sequence and a row of pilot lamps immediately below the meters indicates at any moment the test being made.

torsional rigidity with lateral flexibility, a form of metal bellows, not unlike those used in aneroid barometers, has been adopted.

**Checking Volts and Continuity**

Careful testing of components in the early stages of manufacture considerably reduces the time required for the adjustment and calibration of the complete chassis. The first test to be made on the receiver after it leaves the assembly lines is the checking of continuity and voltage. This tedious but necessary routine, which by ordinary methods might take the best part of an hour, is reduced to a single operation lasting much less than a minute by a special piece of apparatus, the foundation of which is an automatic telephone selector switch. Plugs provided with flexible braided cables are inserted into each valve-holder, and clip connections are made to other parts of the circuit. The selector switch then automatically connects the checking meters to various parts of the circuit in a given sequence. Multiple shunts and series resistances are used to reduce meter readings to a standard deflection in each case, and a series of numbered pilot lamps indicate the test which is being applied at any given moment. All the operator has to do is to note the number of any test which fails to give the required meter reading. Two meters are provided, one for AC and the other for DC measurements, and the limits are usually  $\pm 10$  per cent. The automatic selector switch is set in motion by depressing a single switch, and the time taken for checking the twenty or twenty-five readings is probably less than that required to insert the valve substitute plugs.

The cathode-ray tube plays an important part in the testing both of components and complete receivers. The IF transformers are aligned and checked in

this way before use. In most cases the characteristics of input and output IF transformers are dissimilar, and separate curves are marked permanently on the end of the tube as a reference standard for the use of the operator. The curve not only

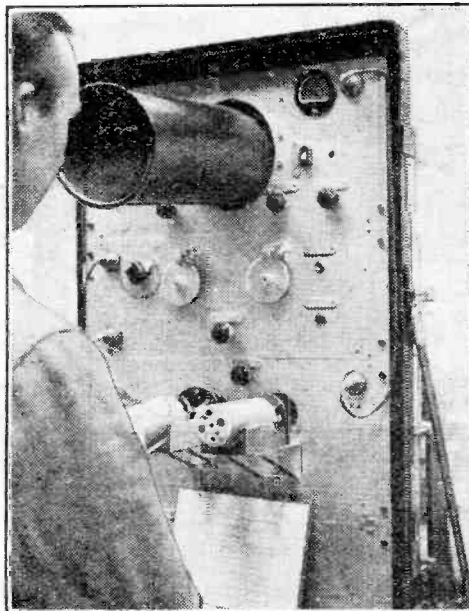

Checking the response curves of IF transformers (above) as individual components and (right) under operating conditions in the complete chassis.

shows when the trimmer alignment is accurate, but also reveals possible discrepancies in the magnetic coupling and capacity between windings. The test unit incorporates a 465 kc/s oscillator, which is frequency-modulated  $\pm 10$  kc/s, the modulator valve being locked to the time base of the cathode-ray tube. The gain of the transformer is also noted on this test by observing the set-

ting of the input attenuator when the resonance curve fits the reference trace.

Later on the IF stage as a whole is trimmed on another cathode-ray test panel. This piece of apparatus is also adapted for testing receivers with a negative feed-back in the LF stages for correct sense of feed-back and for absence of self-oscillation in the feed-back circuit. In the photograph of this piece of apparatus a row of valve-holders will be noticed down the right-hand side. These are provided to keep a supply of substitute valves warmed up to save time in cases where failure to reach the required standard is traced to a faulty valve.

**RF Circuit Alignment**

With the IF and LF stages functioning properly the receiver is now ready for the alignment of the RF and oscillator circuits. In all-wave sets this is done at nine frequencies between 15 mc/s and 150 kc/s. Signals are provided by a self-contained signal generator modulated at 400 c/s, and are applied to the receiver via an artificial aerial, or an artificial frame aerial in the case of portable receivers. The sensitivity is checked at 50 milliwatts output, and the scale is checked to  $\pm 1$  or  $\pm 2$  per cent., depending on the waverange.

Other interesting points in this piece of apparatus are the thorough screening of the signal generator, the tilted jig holding the chassis at the most convenient angle for reading the scale and the massive character of the switchgear used for selecting the required test signal. The same type of switch-operating gear and thoroughness of screening is to be found in the apparatus for testing output transformers. Here, again, we find all tests reduced to a standard meter deflection,

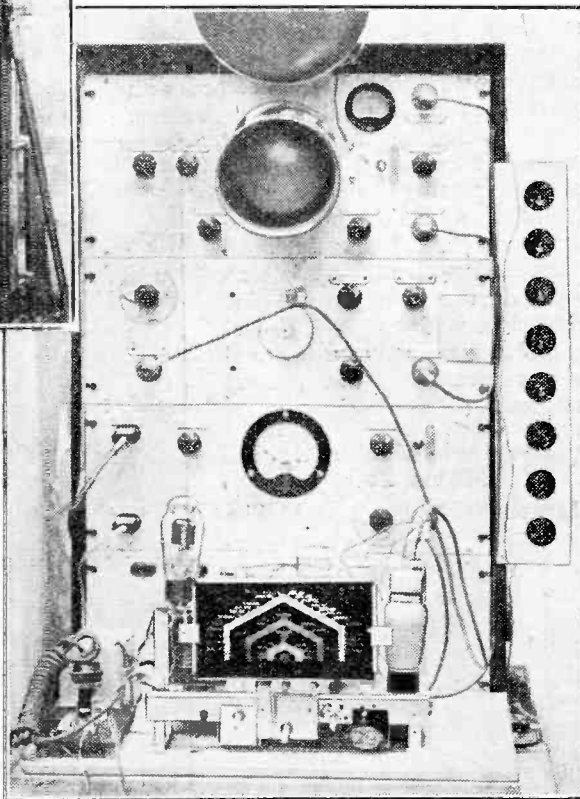



**Factory Test Gear—** and a safety cover incorporating the master switch ensures that the apparatus shall be completely shock-proof. In addition to a 2,000-volt flash test of insulation using a neon lamp indicator, there is a test for magnetising current and overload, a current at 600 v. RMS and 150

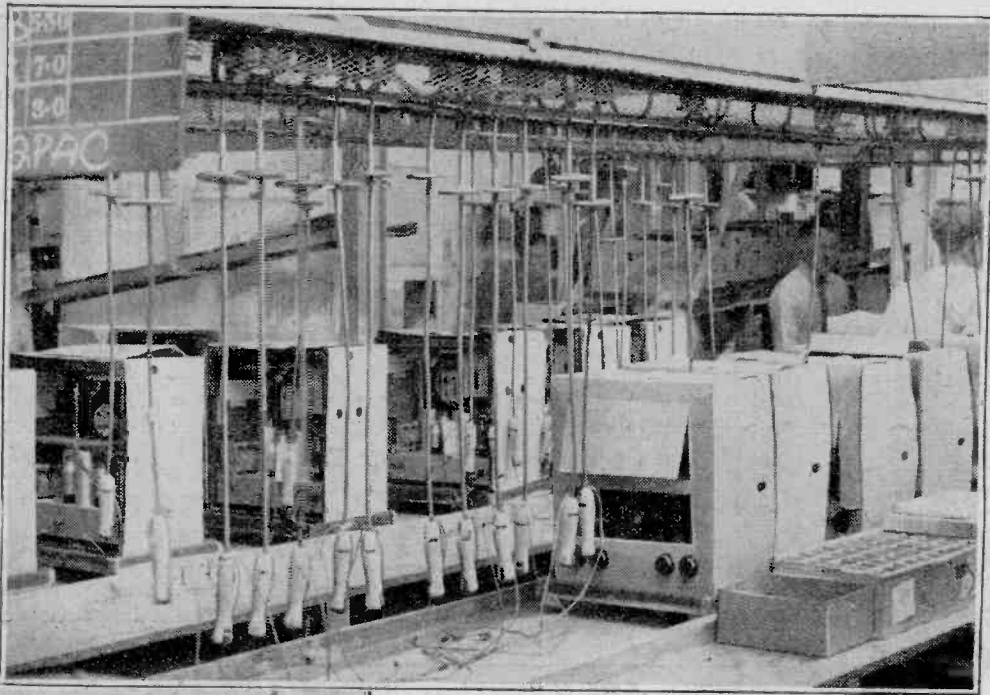

by a series of wire brushes. A sustained test at 1,000 v. RMS 50 c/s is then applied between the external metal-work and mains to ensure that the receiver is absolutely shock proof.

Routine testing is by no means the only work for which special apparatus must be devised. There are frequent enquiries into the overall performance of specimen receivers after production has settled down. A set may be taken at random and a complete overall curve of RF input to acoustic output taken in a special sound-proof room.

The apparatus is entirely automatic, and in a few minutes a curve of the sample is ready for checking against the original. Judging from specimen curves examined, the reflections from the walls of the sound room at very low frequencies are far lower than those usually met with.

Other apparatus has been constructed

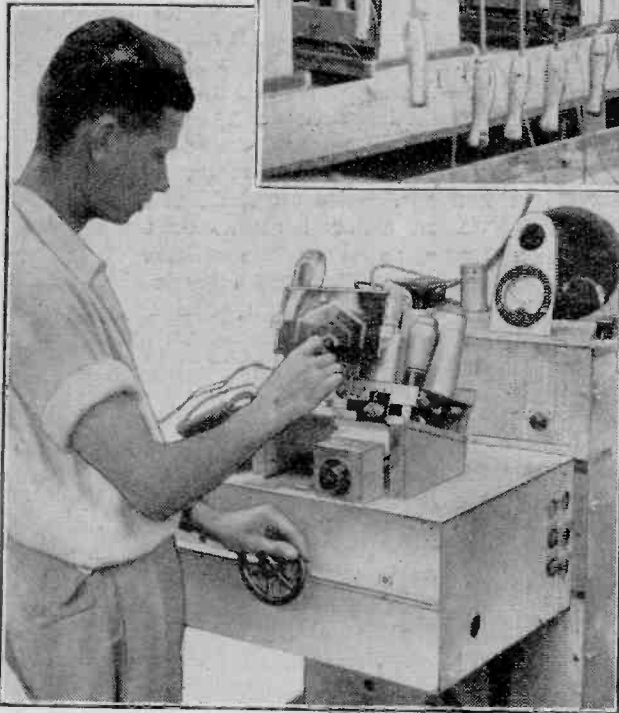

(Above) During packing operations and before the final aural test is made, receivers are run continuously from the mains through leads suspended from an overhead track.

(Left) Alignment of the signal frequency circuits is carried out at nine points in the waverange of the set. The modulated test signal is selected by a rotary switch of massive construction.

(Right) Insulation test "oven" for exposed metal parts in the Baby Q/U receiver.

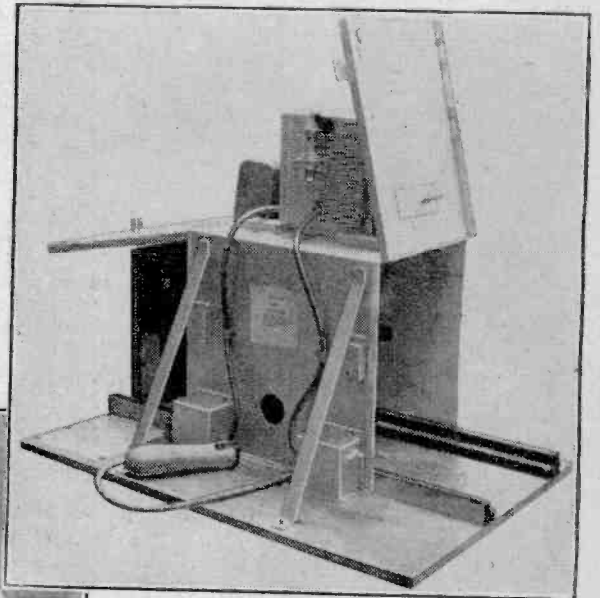

(Below) Testing mains transformers. The current cannot be switched on until the metal cover is lowered.



for the purpose of investigating the suitability of various types of packing case. This metes out punishment of the same type as the set is likely to receive in transit, but in rather a more scientific way, so that results can be compared and suitable modifications made where necessary in the cartons or even in the construction of the set itself. Slight flexing of the chassis, for instance, may call for an increase in the length of wiring between certain points. All these points are cleared up before the first set is delivered, and there can be no doubt that the chances of a faulty receiver penetrating the barriers erected by the testing organisation of a modern factory are negligible.

c/s being applied for this purpose. A neon lamp is also used to show "good" or "bad" on the overload test.

Although this article is concerned with apparatus rather than with test procedure, it was interesting to note that receivers were given their heat test while passing along the packing line, a series of mains-connected leads being attached to screened runners for this purpose. At one point on the line the receiver is given a mechanical jolt and is then ready for the final check of sensitivity and general aural test.

#### Chassis Insulation in AC/DC Mains Sets

In conclusion, we should like to mention a piece of test apparatus designed to ensure safety of handling in the case of the Baby Q/U receiver. This transportable, which is of the universal mains type, is inserted in a small "oven," the doors of which are provided with safety switches, and contact is made automatically to all exposed metal parts



# The Wireless World STRAIGHT

SENSITIVE  
HIGH - QUALITY  
RECEIVER  
UNIT

# SIX

Concluded  
from page  
169  
of last  
week's  
issue

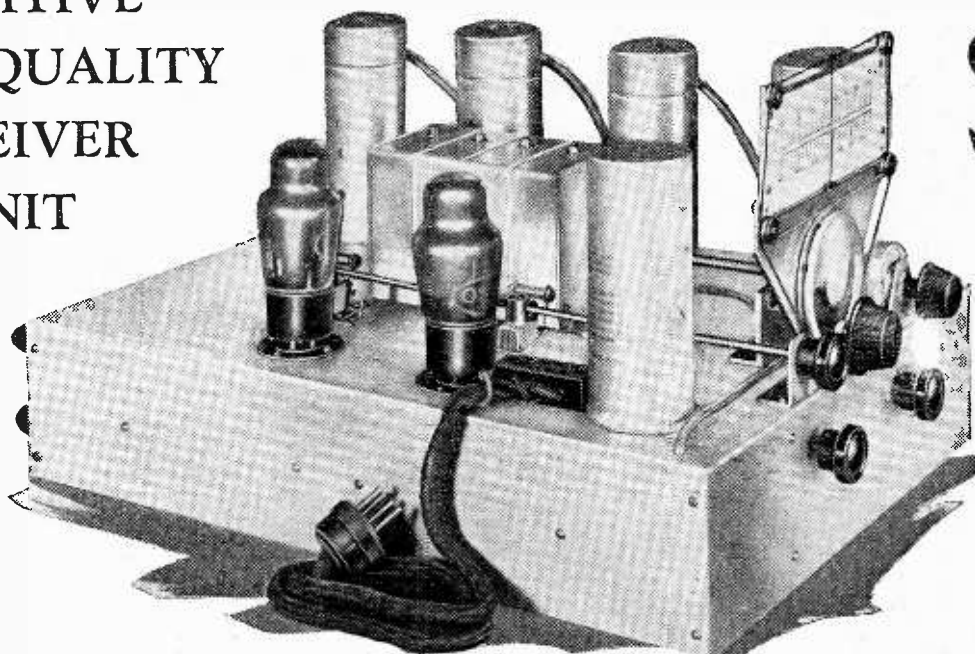

The Receiver  
is Specially  
Designed for  
Use with a  
Push - Pull  
Amplifier

## Details of Construction and Operation

**F**ULL details of the construction of the receiver are given in the drawings which accompany this article, and it is necessary only to point out the importance of care in the wiring. The screens which divide the underside of the chassis into compartments are removable in a piece and most of the wiring can be carried out before they are inserted. This greatly facilitates the construction, but care should be taken to see that the screens make sound contact with the chassis at all points of contact, for any paint or dirt between the faces of the metal will greatly reduce the efficiency of screening.

Before mounting the coils bolts must be placed through the chassis from the underside and nuts run on for mounting the gang condenser. Make sure the nuts are thoroughly tight, for the bolt heads are inaccessible when the coils are in position. The condenser can be mounted last by dropping it over these three bolts and running on nuts.

The wiring should be carried out in the manner of the original receiver both as regards the actual points of connection of the leads and of the disposition of the wires. It is important to note that the screened leads for the anodes of the RF valves must be of the correct material. Large diameter metal-braided sleeving with a thin inner conductor must be used, not metal-braided rubber-covered flex. The clearance between the top-clips of the RF valves and the valve screens is quite small, and as a safety measure it is a good plan to place a disc of thin cardboard in the top of each can.

Turning now to the adjustments, these are extremely easy and are as readily carried out on signals as with a test oscillator. If the latter be available, however, it is a more convenient form of signal. The procedure is to set the receiver to the medium waveband with the tuning condenser at minimum and the selectivity control at maximum selectivity. Set the oscillator at 1,500 kc/s and connect its output to the aerial and earth terminals. Then tune in the signal by means of the four trimmers on the gang condenser.

Now set the oscillator to 1,400 kc/s, tune it in by means of the main tuning control and readjust each trimmer carefully for optimum signal strength.

*IN this article the construction and wiring of the new receiver are described and the initial adjustments are treated in full. These adjustments are easy to carry out and do not necessitate the use of test equipment.*

Audibly the optima will be rather flat on account of the action of AVC in taking up variations in signal strength, so it is a good plan to use a voltmeter connected across R9 as an indicator. Trimming should be carried out for the lowest voltage reading since this corresponds to maximum signal strength.

The next step is to set the oscillator at 600 kc/s, to tune it in on the main control and to adjust the four medium-wave inductance trimmers, again for maximum response. Then go back to 1,400 kc/s and readjust the capacity trimmers.

Ideally, one should go backwards and

forwards between the two sets of trimmers, always adjusting the capacity at 1,400 kc/s and the inductance at 600 kc/s, until no improvement can be made. In practice, however, it will usually suffice to adjust the capacity trimmers twice and the inductance trimmers once as described above.

The long wave inductance trimmers now remain and these are easily adjusted on the long waveband with the oscillator set to about 220 kc/s. This completes the initial adjustments.

When a test oscillator is not available the trimming must be carried out on signals of as nearly as possible the frequencies given above. The precise frequencies used are not important, as they are in the case of a superheterodyne, however, and very considerable latitude is permissible. In London the most convenient stations are usually Fécamp and North Regional, although the frequencies of these differ considerably from the ideal values.

At first, tune in the lowest wavelength local station and adjust the capacity trimmers as well as possible. It should then be possible to find a weak station towards the bottom end of the tuning scale upon which more precise adjustment can be obtained. A station at the other end of the band upon which the inductance trimmers can be adjusted should not then be difficult to find. On the long waveband Droitwich or Luxembourg are the most convenient stations upon which to carry out the adjustment of the appropriate trimmers.

In the matter of performance the writer feels that builders will be agreeably surprised. The sensitivity and selectivity

# Assembly Details and Dimensions—Full Wiring Connections

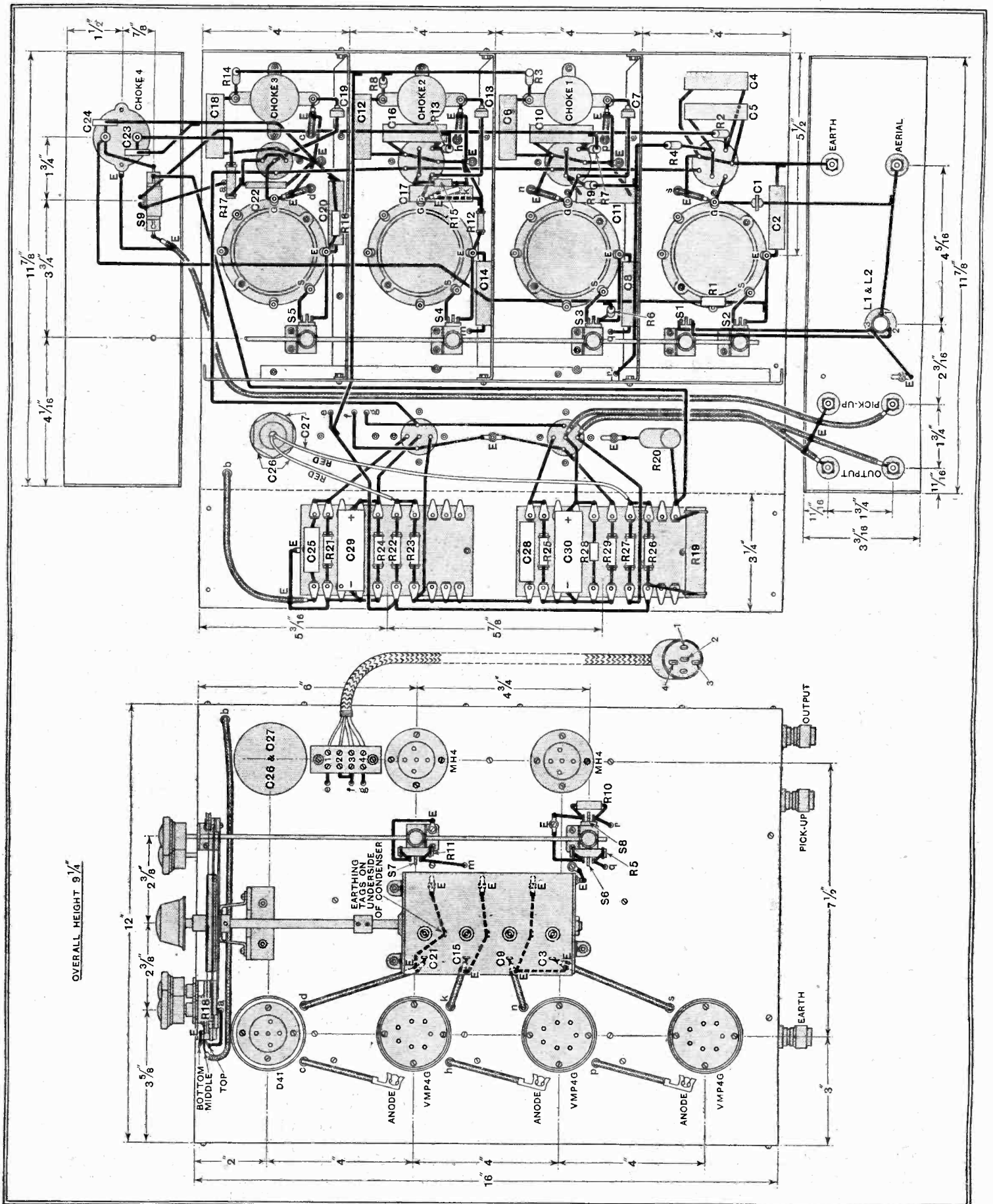

A full-size blue print of the wiring diagram is available from the Publishers, Dorset House, Stamford Street, London, S.E.1. Price 1s. 6d. post free.

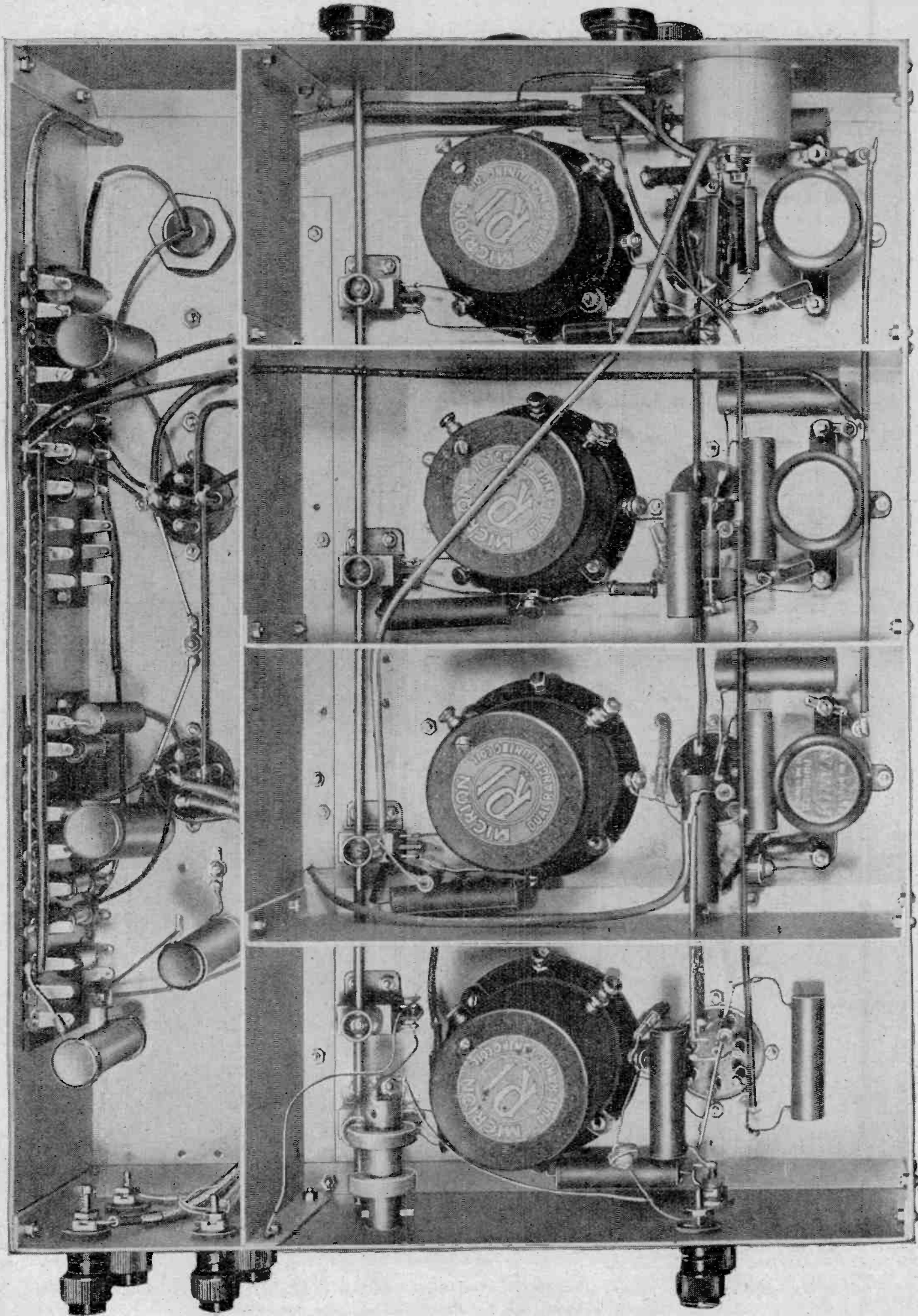

This view of the underside of the chassis clearly shows the chief features of the construction and wiring.



THE STRAIGHT SIX  
AND THE  
PUSH-PULL QUALITY  
AMPLIFIER

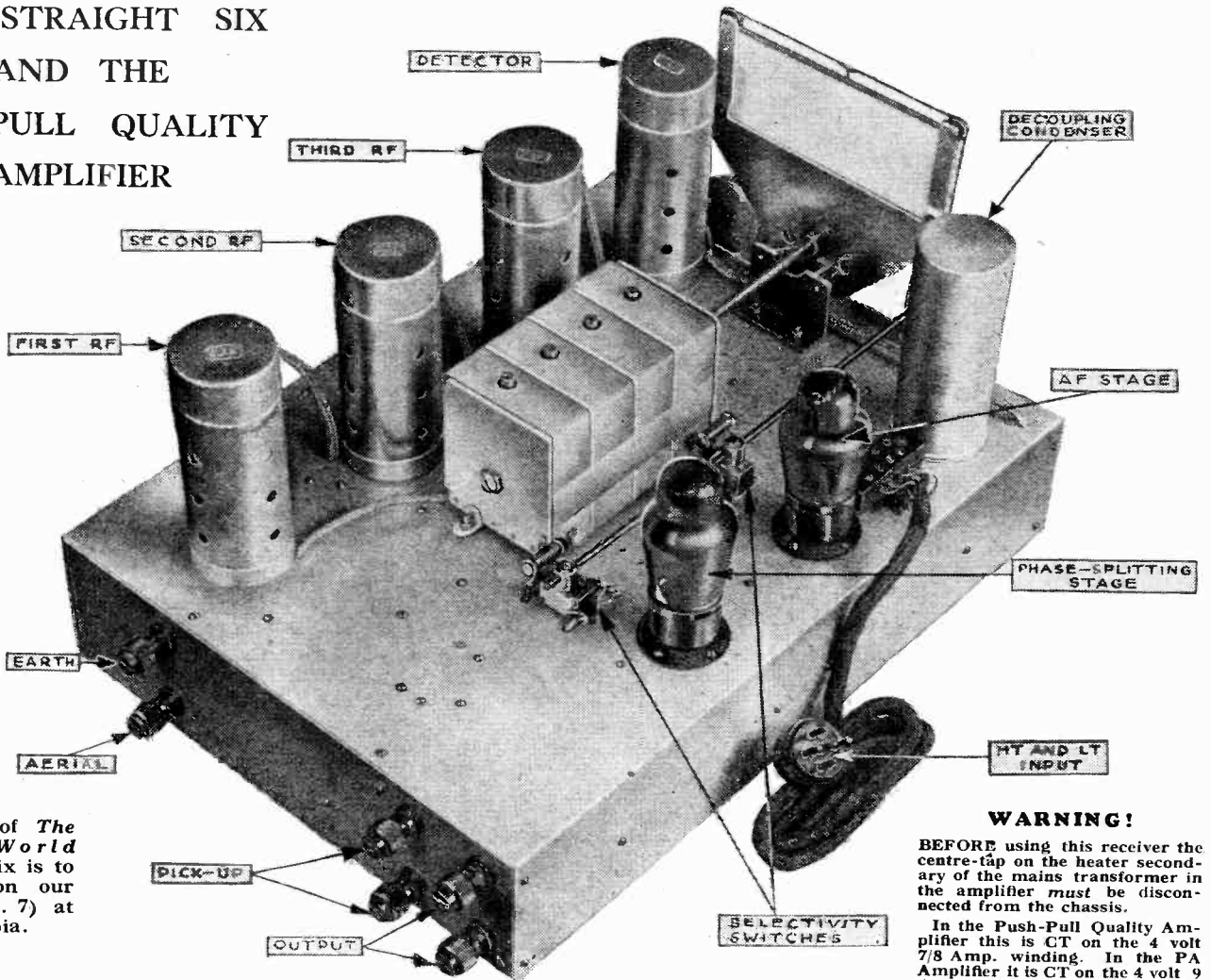

A model of *The Wireless World* Straight Six is to be seen on our Stand (No. 7) at Olympia.

**WARNING!**

BEFORE using this receiver the centre-tap on the heater secondary of the mains transformer in the amplifier must be disconnected from the chassis.

In the Push-Pull Quality Amplifier this is CT on the 4 volt 7/8 Amp. winding. In the PA Amplifier it is CT on the 4 volt 9 Amp. winding, and in the amplifier of the Pre-tuned Quality Receiver it is CT on the 4 volt 10 Amp. winding.

It is imperative that this alteration be made, for if it is not, there is a probability that the mains transformer will be burnt out.

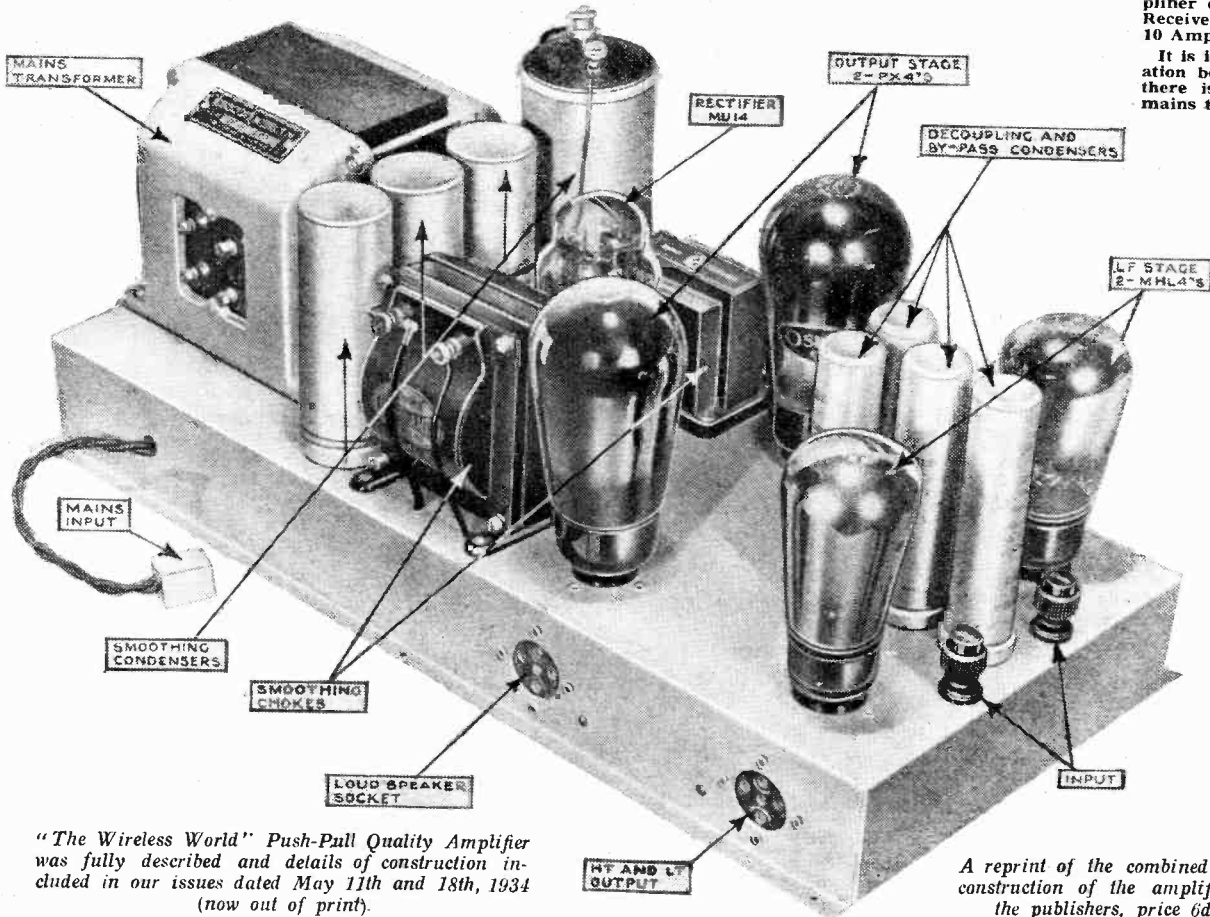

"The Wireless World" Push-Pull Quality Amplifier was fully described and details of construction included in our issues dated May 11th and 18th, 1934 (now out of print).

A reprint of the combined articles describing the construction of the amplifier is available from the publishers, price 6d., or 7d. post free.

**The Wireless World Straight Six—**

are both very high and there is a complete absence of all self-generated whistles. On the long waveband it was found easy to receive the Deutschland-sender while both Droitwich and Radio-Paris were working, the selectivity on this band being actually higher than that of the average superheterodyne.

On the medium waveband the selectivity is naturally somewhat lower, but is still adequate for normal requirements. In fact, it is great enough to cause a very considerable degree of sideband cutting. It was in order to prevent this that it was found necessary to include the selectivity switch so that selectivity could be reduced when interference permits.

At low selectivity, very high quality indeed is secured and the sensitivity is still sufficient to permit the reception of the more powerful Continental transmissions. The limiting factor, however, is rather interference than sensitivity. In the matter of quality the receiver should satisfy the most critical, for not only is the frequency response good, but, of more im-

**VALVE VOLTAGES AND CURRENTS.**

Valve.	Anode Volts.	Screen Volts.	Cathode Volts.	Anode Current.
1st RF VMP4G...	260	115	5.8	mA. 1.1
2nd RF VMP4G...	260	115	5.8	1.3
3rd RF VMP4G...	260	115	3.3	6.1
Det. D41...	—	—	—	—
AF MH4 ...	110	—	1.6	1.1
Ph. Sp. MH4 ...	175	—	40.0	1.3

portance, there is a marked absence of amplitude distortion.

The receiver is designed for use with the Push-Pull Quality Amplifier,<sup>1</sup> the PA Amplifier,<sup>2</sup> or the amplifier of the Pre-tuned Quality Receiver<sup>3</sup> without any modification. It may, however, be used with any good quality amplifier of normal design with but slight alteration.

<sup>1</sup> *The Wireless World*, May 11th and 18th, 1934.  
<sup>2</sup> " " " " April 3rd and 10th, 1936.  
<sup>3</sup> " " " " September 25th and October 2nd, 1936.

**Station Indicator**

IN our issue of July 27th, 1934, we described a type of station indicator with interesting new features. A large scale and station names alphabetically arranged were provided, together with silent tuning by means of the condenser knob, and automatic wave change.

These features had not then been offered to the public on commercial sets, but it is interesting to recall that the trend of development indicated in our article has since become standard practice with a number of set manufacturers; we refer to alphabetical tuning and silent tuning. Automatic wave change which was also included in this new type of station indicator appears to be the next important contribution towards simplified tuning.

Precision Wireless Devices, Ltd., the proprietors of Mr. Naden's patents, inform us that one of the large companies has acquired the right to incorporate this indicator in their new models under licence and that licences under these patents are available to other set manufacturers.

the Fatherland it's *verboten* to do so, though how they enforce the regulation I'm blest if I know. Probably the erring listener is nabbed only when his neighbours hear alien strains coming from his loud speaker and give him away. If that be so, he is clearly a nuisance to those that live near him with his loud speaker, and therefore deserves all that comes to him! But I'll wager that many listeners to forbidden broadcasts would do so simply because they are forbidden, just as the boy who is threatened with dire punishments if he is caught smoking is apt to develop an irresistible desire to puff an illicit cigarette. The pity of it is that there should be any such things as propaganda broadcasts; if countries want to stop their citizens listening to those which they consider undesirable they might well set a good example by ceasing to "propagand" themselves.

**Amazing Figures**

THE wireless licence figures vary curiously in their upward progress at different seasons from year to year. In March, 1937, for instance, the increase was, in round figures, 10,000 less than in March, 1936; in April this year (Coronation approaching) it was, again in round figures, 15,000 more than in the April of the previous year. For May, when so many newcomers had already installed their Coronation sets, it fell away by roughly 5,000 as compared with the same month in 1936. A similar slackening off in the rate of increase might have been expected for June, usually one of the most stagnant of months in the wireless trade; but nothing of the kind occurred. About 5,000 more new licences were taken out that month than in the same month a year previously. For these four months, then, the net increase in licences works out at some 5,000 more than in 1936. We seem still to be some way from the saturation point, despite the fact that rather more than two households out of every three now possess at least one receiving set.

**RANDOM RADIATIONS**

**Here We Are Again!**

AND so Radiolympia is with us once more. As I write it's still a day or two ahead, but when you read this note you may already have paid it a visit. Rumour has been busy these last few days about novelties that are to see the light of day for the first time at Olympia. There'll be some, no doubt, as there always are, but I can't see that there's going to be anything breathtaking. You'll know when you read this whether I'm right or wrong, for if you haven't been to the Exhibition you'll at any rate have read reports on it. What I predict that you'll have seen or read of is a large number of low-priced all-wave superhets by various firms, a smaller, though still very respectable, number of rather better sets selling at from £12 to £15, and a good few receivers with from seven to perhaps 10 valves priced at from £16 to £25 or more. To many of us these last will be the most interesting of all—whether or not we can afford to buy them.

**Nose-Flattening**

That's one of the striking things about wireless. Your real enthusiast yearns to have the best; in fact, if some good fairy presented him with the finest set going he'd at once begin to think of ways in which it could be improved. But if his purse is short he is perfectly happy just looking at

By "DIALLIST"

expensive receivers and, perhaps, building castles in the air! In the days when the home construction of wireless sets was one of the greatest national hobbies I said to the editor of a popular radio paper, now defunct (the journal, I mean, not its editor): "How do you account for the fact that your readers demand a new set design every week? Obviously, they can't all make every one of them." He replied: "They don't. Some build one set, some another; but all the enthusiasts construct every set in imagination." Your enthusiast is just as happy dreaming of what he would do if he owned this set or that as is the impecunious small boy who flattens his nose against the window of a shop displaying model yachts, engines, railways, and so on. And there's one thing about the set or the mechanical model which is yours in imagination only: It is always a super-excellent performer and it never goes wrong!

**Verboten**

NOT for the first time, if my memory serves me aright, certain German listeners have been punished for tuning in propaganda broadcasts from abroad. In

**The Inevitability of Gradualness**

CURIOUS how difficult it is to persuade people that wireless sets do need periodic attention and adjustment if they are to function as they should. Every motorist who is in his right mind looks regularly to the lubrication of his car and to the tyre pressures. At intervals he decarbonises the engine, or has the job done for him. He also does, or gets someone else to do, such things as cleaning out the carburettor, checking the wheel alignment, relining the brakes, and so forth. But he and many other wireless users may expect the receiving set to function day in, day out with no attention at all—until a breakdown occurs. Anything that happens very gradually is exceedingly difficult to notice. Listen to the set evening after evening, and your ear does not observe any slow deterioration in performance that is taking place. It's like the old problem of the man who carried a new-born calf 50 yards and went on doing so day by day as it grew; when would he find that it had become too heavy for him? How bad must a neglected set become as regards sensitivity and quality before its ill deeds force themselves upon its owner's notice?

**Radio Rejuvenation**

It depends, naturally, upon the acuteness of the said owner's perceptions; but it

**Random Radiations—**

is amazing to find how many people who know what a wireless set ought to be and possess, as well, really musical ears can fail to notice for a long while the effects of deterioration, though these may be immediately and aggressively apparent to one who hears it for the first time or afresh after a longish interval. I came recently across a case very much in point. I was staying with a friend whom I had not visited for some six months. His large and expensive receiver was just horrible to hear when he turned it on, though I knew from previous experience that it should be nothing of the kind. A few minutes at the controls showed that it was putting up nothing like a proper show as regards sensitivity or selectivity and that it had developed several unpleasant self-generated whistles. I suggested that no harm could come of valve tests and of tests for circuit alignment. These were made the next morning, and disclosed that five out of the seven valves were done for and that the alignment was hopelessly out. Properly lined up and fitted with new valves, the set became its old self once more, and its owner could hardly believe that he had tolerated its recent performances.

**Well Worth While**

The moral is clear. The ear is a gay deceiver when it comes to a slow falling off in the performance of a wireless set. It may let you down badly if you trust to it alone, for as performance gradually deteriorates the ear accustoms itself to expect nothing better. It is meters, and meters alone, that can give the cold, hard facts. If you're wise you'll see that your valves are given the once over at regular intervals. You'll see, too, that your circuits with "fixed" tuning are properly lined up by means of a signal generator and an output meter.

**Polytechnic HF Engineering Course**

THERE is to-day an ever-increasing necessity for servicemen, and others associated in any way with the radio industry, to have a really sound technical knowledge of their subject. Moreover, owing to the use of technical principles common to all three, it is becoming more and more desirable for persons associated with radio, television, or talking film work to have at least some knowledge of all of them. These points have been fully realised by the Polytechnic, which has arranged a special five-years' course in high-frequency engineering in which all three of these subjects will be dealt with.

Although intending students are strongly advised to take the full course, it is realised that many of them will only wish to take one particular part of it, and this will, therefore, be permitted. For the full course a charge of thirty shillings per session will be made for the first three years, and two pounds for the fourth and fifth years. Students not taking the full course are charged in accordance with the particular subjects they take, fees being in any case very moderate. The course, which is taken on week-day evenings (except Saturdays), commences on September 20th.

Those interested are advised to send for the full prospectus, while, for the benefit of those who care to seek personal advice in the matter, the head of the electrical engineering department and his staff will be in

**Next Week's Issue**

## THIRD SPECIAL NUMBER REVIEW OF THE SHOW

A considered analysis of the season's apparatus based on careful study and comparison of the exhibits by *The Wireless World* technical staff.

Modern sets "stay put" remarkably well, but the effects of vibration and of climatic variation are bound to tell their tale in time. It is particularly important to check up and adjust, at intervals not too widely spaced, the small superhet, which can put up a reasonably good show only if its valves are right up to the mark and their associated circuits in the HF and IF departments properly keyed up.

## Philco Programme Models for 1937-8

BY far the most ambitious of the present Philco range is the Empire Twenty-two, with automatic tuning on all its five wavebands and 15 watts output from push-pull triodes. Another interesting set is the Empire Eight, a four-band AC set with a four-position tone control. The U647 is an AC/DC six-valve superhet, also covering four bands, which is available in several different forms.

After several intermediate models comes the series of low-priced "People's Sets," available for battery, AC, and AC/DC supply. "De luxe" and all-wave models of this popular receiver are also produced. Philco car radio completes the programme.

attendance from 6-9 p.m. from September 13th to 17th. All communications should be addressed to the Electrical Engineering Department (Telecommunications Section), The Polytechnic, 307/311, Regent Street, London, W.1.

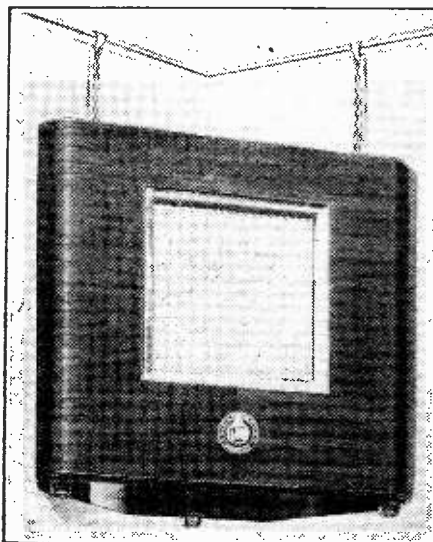

A CORNER CABINET SPEAKER designed for hanging from the picture rail. This is one of the Wharfedale new season's series, which is summarised on page 224.

**Notes and News****European Exhibitions**

SO far eighty firms have taken stands for the Brussels Wireless Show, which will be held from September 4th to the 11th.

An interesting fact about the Toulouse Wireless Exhibition, which will be open from October 2nd to the 10th, is that there will be no entrance fee. By this means it is hoped that a large attendance will be assured, and the interest of many chance visitors to the show sufficient to make them become regular broadcast listeners.

**Italy Takes Television Seriously**

IN order to permit Italian television engineers, who have completed a university course in their own country, to continue their studies in Germany, Great Britain and the U.S.A., special scholarships have been founded.

**Listening in China**

DESPITE the huge population of China it is estimated that there are not more than 300,000 sets in use in the whole country, and of these 50,000 are in the Shanghai area. The main reason is that a set is far beyond the financial means of most of the population.

**Three Thousand Miles to Charge a Battery**

IN these times, when even television is becoming a commonplace, it is surprising to learn that there is one land station at which the transmitter consists of a primitive battery-operated spark coil, and the receiver is of the crystal type. According to *QST*, the official organ of the American Radio Relay League, this anachronism is situated at Pitcairn Island, of "Bounty" fame, and was installed in 1920. In spite of its limitations, the operator is able to carry on two-way working with ships up to a distance of about four hundred miles, while he can "read" them over a thousand miles away. When first installed a small petrol-operated battery charger was supplied, but petrol is at a premium in the South Pacific and it is actually found more convenient to send the accumulator some thousands of miles to New Zealand to be re-charged.

**More Modern Warfare**

RECENTLY there was a report published in *The Wireless World* that both sides in the Spanish Civil War have adopted loud speakers as the latest weapon in the conflict, further developments have taken place, each side trying to outdo the other in the matter of volume. The din is said to be terrific and can be heard far behind the lines. The amount of power used by each side is increasing daily, and the amplifier and loud speaker designers in the opposing camps are said to be working to produce instruments of greater and greater power-handling capacity.

**The Dollis Hill Radio Communication Society**

A SPECIAL meeting will be held at Radiolympia at 6 p.m. on Saturday, August 28th. The rendezvous will be in front of *The Wireless World* stand. Members are asked to make a special effort to turn up.

**"Inexpensive Amplifier"****Tone Control System**

IN describing this amplifier in the issue of June 18th, it was promised that a sequel would appear giving details of a flexible and comprehensive tone control system. Many enquiries for this have been received, the description has been prepared, and it is hoped to include it in our issue of September 10th. The delay in publication is regretted.

# Listeners' Guide for the Week

## Outstanding Broadcasts at Home and Abroad

**U**NDER the general heading of "Science at your Service!" the B.B.C. has arranged a number of talks to be given during the annual meeting of the British Association which this year is being held at Nottingham from September 1st to September 8th. The speeches at the meeting are, of course, fully reported in the Press, and these talks are to be given with the idea of enabling the layman more fully to grasp the significance of the various discussions. The subjects therefore selected for these talks will be those that have a bearing on our daily lives.

On Saturday a discussion, on "Why we Meet," between Professor Allen Ferguson, one of the General Secretaries of the Association, and H. A. Wortley, Principal of University College, Nottingham, where the meeting is taking place, will be heard by National listeners at 10.

Professor Julian Huxley will give his impressions of the opening of the meeting at the close of his talk in Wednesday evening's programme at 10. His talk will deal with Sir Edward Poulton's Presidential address on the History of Thought on Evolution.

The conclusions reached during the discussion between economists and psychologists on the question of transference of labour will be brought to the microphone for National listeners on Thursday at 8.55.

Further talks will be given next week on a variety of subjects ranging from "Noise and the Nation" to "Replanning this Land of Britain."

### FARR-LOUIS FIGHT

FOR those who did not, or would not, get up at 2.50 this (Friday) morning to tune in the National transmitter to hear Bob Bowman's commentary from the ringside during the Farr-Louis fight, nor the edited edition given at 6 and 7 a.m., there will be an opportunity of hearing the edited version to-night at 8 (Nat.).

The direct broadcast by the B.B.C. of this commentary is another of those occasions when the Corporation takes advantage of the facilities placed at its disposal by the N.B.C. of America. Bob Bowman, of course, is not with the N.B.C. but with the Canadian Broadcasting Corporation, by whose courtesy this commentary, by a former member of the O.B. staff of the B.B.C., is given.

### THE "EGYPT'S" GOLD

FIFTEEN years ago the P. & O. liner *Egypt* was sunk in the Bay of Biscay after colliding with the French cargo steamer *Seine* during a dense fog. She was carrying millions of pounds in bullion, and a certain Commandator Quaglia thought that it might be possible to salvage this fortune that lay 60 fathoms below the surface. With two salvage vessels, the *Artiglio* and the *Rostro*, he set out for the approximate position of the wreck. After months of trawling and many false finds, the

Gerry Fitzgerald, who are so well known to listeners for their shows "Music from the Movies"; the Dagenham Girl Pipers and Drummers, and Paula Green will be heard during this and the last relay on September 4th. Phyllis Robins, the Royal Mastersingers who were heard last Wednesday, and Flotsam and Jetsam also appear on the bill.

### PROMENADE RELAYS

OUTSTANDING among the relays from the Queen's Hall this week, which total eight hours,

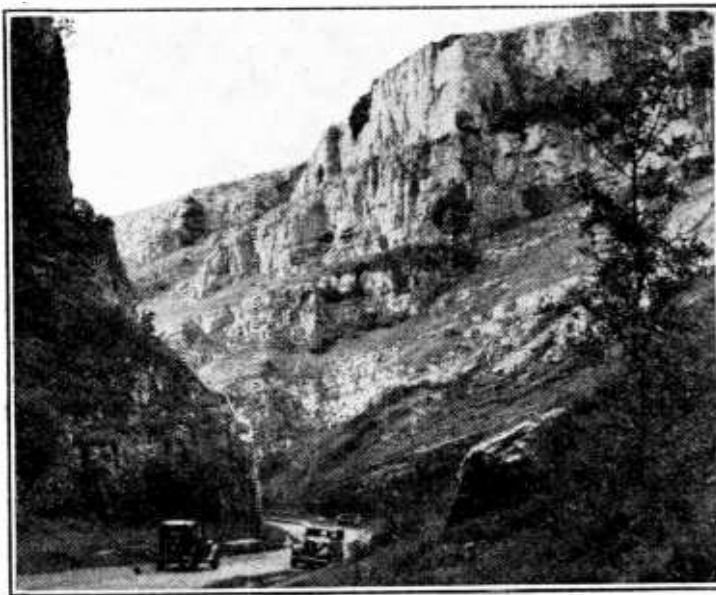

**CHEDDAR GORGE**, the famous Mendip beauty spot, which is flanked by magnificent cliffs rising to some 450 ft., contains two caves which present remarkable examples of stalactite formation. Listeners will be given a sound picture of a tour of the Gorge and Caves by guides and trippers, including Tommy Handley, on Saturday at 9.15 (Reg.).

*Egypt's* position was located and success finally crowned the efforts of Quaglia and his intrepid divers.

The programme featuring this drama of the sea was first broadcast in 1934 and was hailed as a really thrilling actuality feature. Those who heard it then will doubtless take the opportunity of listening in on Sunday at 9.30 (Nat.), when it will be revived, whilst those who have not previously heard it should not miss the opportunity.

### RADIOLYMPIA

ANOTHER hour's broadcast from the R.M.A. Theatre at the Radio Exhibition is scheduled for Monday at 8 in the Regional programme. Louis Levy and his Symphony with Janet Lind and

are those on Saturday, Monday and Wednesday.

From Saturday's popular concert comes a relay at 8 (Nat.), which will include Albert Sammons playing Delius' Violin Concerto, and Keith Faulkner singing Vaughan Williams' Songs of Travel.

The Wagner concert on Monday will bring to listeners at 8 (Nat.) Oda Slobodskaya as Sieglinde and Parry Jones as Siegmund singing the love duet from the first Act of "Die Walküre." Siegfried's journey to the Rhine from "Götterdämmerung" will also be heard.

Clifford Curzon will play Brahms' first Pianoforte Concerto during the relay of Wednesday's concert at 8 (Nat.).

### COCKNEY

SOME of the amusing incidents during a trip made by Ernest Longstaffe and Max Kester in a Thames steamer from Tower Bridge to Margate will be included by them when they produce the show "Come Along Liza" on Thursday at 7.40 (Nat.), and again Regionally the following day. It was in search of "atmosphere" for this production that the two B.B.C. producers went on this trip, and they found an abundance of material for inclusion in this programme which deals with a Londoner's day's outing. The complete Buggins family will go for this outing in the radio story. A newcomer to the microphone will be George Inns, who was a great hit as a comedian in a B.B.C. staff pantomime. He has been in the Effects and Variety departments.

### FOLK-LORE

THERE is a good sprinkling of programmes devoted to folk-music in the bills of fare from abroad.

From Leipzig at 8.10 on Saturday comes a programme entitled "A Village Evening from Töpferbaude." This comes from an interesting village not far from the Saxon town of Zittau, where the composer Marschner was born. The hamlet is situated in the shade of a wooded rock, which is crowned with the picturesque ruins of a monastery and a castle.

"Between the Dolomites and High Tauren" is the title of a programme of folk-songs and dances of the Eastern Tyrol which comes from Deutschlandsender at 7 on Sunday.

On Thursday at 9.15 Frankfurt gives "Love's Joys and Grievs," which is a programme of folk-songs and choral music.

### SCANDINAVIAN RADIO SHOW

PRINCE FREDERICK OF DENMARK will open the Danish Radio and Music Show of 1937 at 1 o'clock to-day (Friday), when the ceremony will be broadcast.

The Forum Hall, which houses the show, has a theatre seating about 1,000, which will provide a number of programmes for the Danish stations. To-night at 9 will be heard the Danish national opera "Maskarade" by Carl Nielsen, with the Royal Theatre Orchestra and Denmark's stars.

On Thursday at 7.30 Johanne Stockmarr, who at one time was frequently heard from the B.B.C. stations, will give a pianoforte recital from the theatre. THE AUDITOR.

The weekly list of Highlights will be found on the next page.



# Broadcast Brevities

## NEWS FROM PORTLAND PLACE

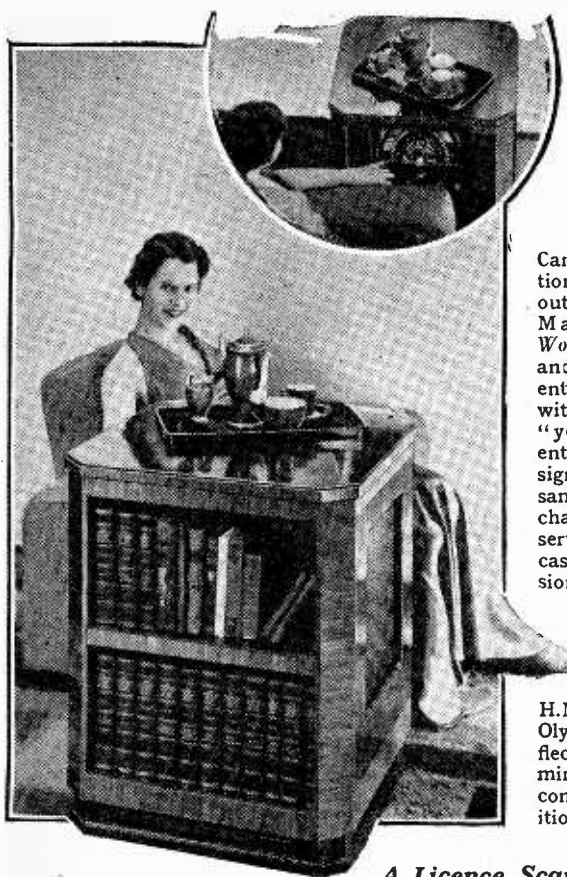

Can the conventional receiver layout be improved? Many *Wireless World* contributors and correspondents have replied with an emphatic "yes," and apparently H.M.V. designers are of the same opinion. This chair-side cabinet, serving as a bookcase and an occasional table, houses along-range five-band superheterodyne, and is one of the H.M.V. exhibits at Olympia. The reflection in the mirror shows the convenient disposition of controls.

### Farr-Louis Fight: B.B.C. Dilemma

WHY couldn't the B.B.C. take the American commentary on the Farr-Louis fight? Why is it necessary to bring Mr. Bob Bowman from Canada when the N.B.C.'s own commentator will be giving a vivid description in English? These questions have been fired at Portland Place by a number of listeners who have overlooked one little point.

### A Sponsored Programme

The Farr-Louis broadcast by the N.B.C. was sponsored by General Motors, and it was therefore to be expected that mention would be made of the fact. Probably during the hottest moments of the encounter American listeners would be reminded that the sound of each blow was coming to them by courtesy of that enterprising business firm.

Fortunately, or unfortunately, the B.B.C. is precluded by the terms of its charter from radiating an advertising programme, no matter in what country it originates.

### Canada to the Rescue

Major Gladstone Murray, formerly Public Relations Officer of the B.B.C. and now Director-General of Canadian Broadcasting, saw the difficulty confronting the B.B.C., and offered the services of his ace commentator, Bob Bowman. The Corporation jumped at the offer, the more readily as he is so well known to listeners.

### A Licence Scare

A LOT of blah has appeared about the alleged drop in licence figures. This is probably due to the method of compiling the figures, for the one thing obvious is that licences are still on the increase.

What our enlightened critics have been doing has been to note the "cessations" (to use the official term) in each district without observing the increases in the same period. Naturally, there are cessations in every district, but, generally speaking, these are offset by a bigger increase. A case in point is that of Edinburgh, which is reported to show a decrease in the last month. Actually, the Scottish capital, despite cessations, has shown a net increase in the past six months of 1,378.

### The Nine Millionth?

Even odds are being offered that the closing date of Radiolympia will see the licences reach the nine million mark.

### Val Gielgud's "Holiday"

"DEATH IN BUDAPEST" emerged from the meeting of Val Gielgud, B.B.C. Drama Director, and Eric Maschwitz, in the Hungarian capital while the two were on "holiday." The story, which should make a lively tale for microphone or screen, is a successor to their best-selling thriller, "Death at Broadcasting House."

Mr. Gielgud's immediate job is the production of three large-scale programmes, two of which will be heard by British lis-

teners. They are "The Little Mermaid" and "The Last Fight of the Revenge." The third is that memorable programme, "Marseillaise," already broadcast in Britain, which is to be relayed across the Atlantic to the Columbia Broadcasting System at the invitation of Irving Reis, of the Columbia System, who wished to offer his listeners an example of modern radio drama from England.

The broadcast will take place from midnight to 12.30 a.m., on September 13. Gielgud hopes to collect most of the members of the original production.

### Talk About Talks

IN a few days' time the B.B.C. will, it is understood, announce details of a Listener Research Scheme in connection with talks. It will follow to some extent the lines of the radio drama inquiry already referred to in "Broadcast Brevities"; but certain differences will have to be borne in mind.

While there are many listeners interested in radio drama as such, few, if any, are interested in talks for their own sake. (Has anyone met a talks enthusiast?)

### "Special Juries"

Those who listen to talks are attracted purely by the subject matter and it would be hopeless, therefore, to expect a general public vote to yield any useful information on the value of talks as a whole.

What the B.B.C. has in mind is the formation of panels, each composed of listeners interested in a number of cognate subjects. The public may be invited to join panels concerned with talks on history, or travel, or economics, the idea being to form special juries, as it were, in contrast to the general jury voting on radio drama.

All of which shows that the B.B.C. is at last trying very hard to solve that fifteen-year-old problem: What do Listeners Want?

### HIGHLIGHTS OF THE WEEK

#### FRIDAY, AUGUST 27th.

Nat., 7.30, Five Hours Back. 8, Recording of Farr-Louis Fight commentary.

Reg., 8, "Yes, and Back Again"—King Bull's play. 9, Northern Music Hall.

#### Abroad.

Radio Normandy, 8.30, Bizet's "Carmen," relayed from the Casino, Fécamp.

#### SATURDAY AUGUST 28th.

Nat., 5.15, Billy Thorburn and his Music. 8, Promenade concert.

Reg., 6, Band of H.M. Scots Guards. 8.15, Variety, including Elsie Carlisle and Jeanne de Casalis. 9.15, Evening in Cheddar.

#### Abroad.

Marseilles PTT, 7.5, Mozart's "Don Giovanni," from the Festspielhaus, Salzburg.

#### SUNDAY, AUGUST 29th.

Nat., 9.5, Violin recital, Szigeti. 9.30, The *Egypt's* Gold.

Reg., 4, Violin recital, Telmanyi. 9.30 B.B.C. Orchestra (C) and Adelina de Lara (piano).

#### Abroad.

Berlin (Funkstunde), 8, Dances and Songs of the Nations.

#### MONDAY AUGUST 30th.

Nat., 7.30 The Song is Ended: a reminiscent programme of popular songs. 10.15, "Laugh This Off": anthology of American humour.

Reg., 8, Variety from Radiolympia. 9.30, The Rocky Mountaineers. 10, The Poznan Cathedral Choir, relayed from Poland.

#### Abroad.

Radio Paris, 7.5, Mozart's "Figaro," from the Festspielhaus, Salzburg. Soloists include Lotte Lehmann.

#### TUESDAY, AUGUST 31st.

Nat., 8, The Abbey Players in "The Playboy of the Western World," relayed from the Abbey Theatre, Belfast. 10, Sir William Beveridge on Unemployment Insurance.

Reg., 8, Busoni Prom. 9.40, "The Marmalade Mystery": a musical burlesque in rhyme.

#### Abroad.

Radio Paris, 9, Gala farewell concert for the Casino Orchestra, relayed from Knocke.

#### WEDNESDAY SEPTEMBER 1st.

Nat., 8, Brahms Prom. 10.20, Noel Coward's music.

Reg., 8, "The Builders of England": satire on jerry-building. 9.10, "The Playboy of the Western World," from Belfast.

#### Abroad.

Strasbourg, 8.30, Symphony concert from Paris.

#### THURSDAY, SEPTEMBER 2nd.

Nat., 7.40, "Come Along, Liza." 9.10, Summer in Northern Ireland.

Reg., 6.45, Shows from the Seaside—IX. Boscombe Pier "Bubbles" concert party from Bournemouth Pavilion. 9.40, Commentary on the final heats for the World's Speedway Championship.

#### Abroad.

Frankfurt, 9.15, "Love's Joys and Grievs": folk-songs and choral music.

# In Search of Radio Shows

I SUPPOSE that by now, although the Show is but two days old, all you really keen wireless men have seen it several times over, especially those stalwarts from the North who always seem to know far more about London and what's doing in it than do the Londoners themselves. I am afraid that I can't claim to have seen a terrific amount of it myself as I am still feeling fagged out as a result of my abortive attempt to get to the Berlin Show a week or two back.

I had fully made up my mind to visit the Berlin Show this year as I had heard such a lot about the wonders which were to be exhibited there, including television, which was supposed to be as far in advance of ours as ours is of the old 30-line system. It was therefore with keen feelings of pleasurable anticipation that I packed my grip and hurried down to Harwich to board the Hook of Holland boat on my way to the Fatherland. I took an early afternoon train instead of the usual boat train as I had a business call to make in Harwich, but this completed, I lost no time in going on board and seeking my bunk in preparation for the strenuous activities of the morrow.

All went as merrily as a marriage bell until the next morning—smooth sea, comfortable ship and congenial company. I must confess that when I emerged on deck about 5 a.m. after enjoying my morning Kruschen at the bar, I was somewhat surprised not to see any signs of land, as the L.N.E.R. boats are noted for their punctuality, but there had, I recollected, been some fog hanging about the night before, and, no doubt, I reflected, we were somewhat behind time in consequence.

It was not until mid-day rolled round and still no signs of land that I began to feel at all uneasy, my uneasiness being



One man's meat . . .

physical as well as mental as a nasty sea had got up during the morning, and the boat was beginning to wallow badly. I therefore took a few quick strides along deck and mounted the bridge and dis-

covered the Captain just emerging from the chart-room where, no doubt, he had been to have a quick one.

In reply to my query as to why we were so late he astounded me by replying that we were dead on time, and should be in by about 5 p.m. as usual. My sarcastic enquiry as to why an extra half-day had been added to the journey merely brought a look of honest bewilderment to his face and it was soon apparent that we were talking at cross purposes. Subsequent explanation revealed the fact that in my eagerness to get to the exhibition, I had boarded the Danish mail boat at Harwich instead of the Hook boat.

Had it not been for the foolish habit adopted by ships of not flying their national flag when on the high seas, I

## By FREE GRID

should no doubt have found out my mistake much earlier. Even the language question had not helped me as 90 per cent. of the passengers were English holiday-makers bound for Scandinavia, and the strange lingo spoken by the sailors I had mentally put down as the East Anglian dialect, which, after all, to an untutored ear does not sound so greatly dissimilar to Danish.

The upshot of the affair was that I finally found myself in Denmark, as the Captain simply would not listen to my suggestion to deviate from his course in order to land me on a convenient spot on the Dutch coast where I might catch a train to Berlin. Having arrived at the port of Esbjerg I made up my mind to change my plans and investigate wireless conditions in the land of Hamlet. I must confess that the tempo of life in what, temperamentally speaking, I have always considered these cold northern latitudes, was far greater than I had ever thought possible, and that is why my wireless investigations have left me so exhausted.

However, to return to Radiolympia. The first thing which struck me on passing the turnstiles was not, as you might think, the magnificence of the scheme of decoration or the exhibits, but a hammer dropped by some workman feverishly putting last-minute touches to an exhibit in the gallery. Unfortunately, the article was not of great use to me as I already possess a plethora of them, but as you never know when things may be useful for part exchange purposes, I did not resort to vulgar reprisals by throwing it back.

As I had scarcely gone half a dozen paces farther before I was narrowly missed by another of these homely domestic articles, I began to suspect that their dropping like Manna from heaven was not so accidental as I had at first supposed. However, no further incident of this



Striking entrance at Olympia.

nature occurred and I was soon hunting amid the bevy of theatres and sideshows for the wireless exhibits, and after getting through the labyrinth of outer defences in the shape of salesmen and other foolish stand decorations, I eventually got to the meat of the show and was soon happily engaged in delving into the vitals of several promising-looking sets.

There is one thing which stands out a mile in the exhibition as being in such great contrast to the shows of many years ago, and that is that the old foolishness of "secret circuits" has been abolished. Instead of the salesmen replying to technical questions with inane smiles and babblings about patent circuits which have been worked on by the firm's technical experts behind locked doors for months past they all looked rapidly astonished when questioned about the circuit and proceeded to dilate at great length upon the relative advantages of Chippendale and Heppelthwaite.

It soon became apparent to me that the circuits were so secret that the manufacturers had not even disclosed their existence to the salesmen, and one immaculately clad young man was patently astonished when I removed the back of an ornate-looking cabinet and began to draw out valves and screening cans galore, and he excitedly pointed me out to a colleague, being apparently under the impression that I was a "turn" from Maskelyne and Devants.

Before I go any farther there is one very strong complaint which I wish to make against the organisers of the exhibition, and that is the very grave shortage of sleeping accommodation at the Show. Although the exhibition is but two days old I already feel as tired and dishevelled as if I had been on one of those widely advertised Mediterranean cruises, or "boozes" as they are called nowadays. On the first night I was fairly lucky as I managed to find rest for the body and refreshment for the inner man on the premises of the Exhibitors' Club, but on the second night, which has just dragged its weary length to a close, I found a suspicious-looking nightwatchman in charge.

[More Revelations Next Week—ED.]

# GUIDE TO STANDS AND EXHIBITORS AT OLYMPIA

## Alphabetical List with Stand Numbers and References to the Plans

Name.	Stand.	Reference.	Name.	Stand.	Reference.
Ace Radio .. .. .	103	B 4	Halcyon Radio, Ltd. .. .. .	35	D 2
Aerialite, Ltd. .. .. .	28	D 3	Harries Thermionics, Ltd. .. .. .	3	D 4
Aerodyne Radio, Ltd. .. .. .	52	C 1	Harris & Russell, Ltd. .. .. .	T. 12	E 1
All Power Transformers, Ltd. .. .. .	209	H 4	Haynes Radio, Ltd. .. .. .	11	D 3
Amalgamated Press, Ltd. .. .. .	13	D 2	Heayberd, F. C., & Co. .. .. .	25	D 2
Ardente Acoustic Laboratories .. .. .	2	C 4	Henley's, W. T., Telegraph Works Co., Ltd. .. .. .	20	D 1
Armstrong Manufacturing Co. .. .. .	220	E 4	High Vacuum Valve Co., Ltd. .. .. .	27	D 3
Assurance Finance Trust, Ltd. .. .. .	219	E 4	Hillman Bros., Ltd. .. .. .	216	F 4
Automatic Coil Winder & Elec. Equip. Co., Ltd. 30 & 166	D 4 & H 3		Hobday Bros., Ltd. .. .. .	T. 10	E 1
			Houghtons (Ensign, Ltd.) .. .. .	T. 19	G 1
			Hunt, A. H., Ltd. .. .. .	155	H 2
<b>Baird Television, Ltd.</b> .. .. .	87	A 4			
Balcombe, A. J., Ltd. .. .. .	55	C 3	<b>Iliffe &amp; Sons, Ltd.</b> .. .. .	7	D 3
Barratt & Robinson, Ltd. .. .. .	201	H 4	Invicta Radio, Ltd. .. .. .	56	D 3
Beethoven Radio, Ltd. .. .. .	34	D 3			
Belling & Lee, Ltd. .. .. .	42	B 1	<b>Jackson Bros. (London), Ltd.</b> .. .. .	93	A 1
Benjamin Electric, Ltd. .. .. .	17	D 1			
Bernard Jones Publications, Ltd. .. .. .	105	NH	<b>Kolster-Brandes, Ltd.</b> .. .. .	65	B 1
Bifurcated & Tubular Rivet Co., Ltd. .. .. .	151	H 1			
Bowmaker, Ltd. .. .. .	217	F 4	<b>L.E.S. Distributors, Ltd.</b> .. .. .	T. 6	E 2
Bridger, R. O., & Co., Ltd. .. .. .	150	H 1	Lissen, Ltd. .. .. .	73	B 3
Britannia Batteries, Ltd. .. .. .	83	A 2	Lugton & Co., Ltd. .. .. .	T. 15	F 1
British Belmont Radio, Ltd. .. .. .	79	A 1			
British Broadcasting Corporation .. .. .	51 & 78	C 1 & B 1	<b>McMichael Radio, Ltd.</b> .. .. .	59	C 4
British Centralab, Ltd. .. .. .	153	H 2	Manufacturers Accessories Co. (1928), Ltd. .. .. .	T. 4	E 3
British G.W.Z. Battery Co., Ltd. .. .. .	82	A 2	Marconiphone Co., Ltd. .. .. .	53 & 64	C 2 & C 1
British Mechanical Productions, Ltd. .. .. .	94	A 1	May & Baker, Ltd. .. .. .	157	H 2
British Metal Engraving Co., Ltd. .. .. .	158	H 1	Mercantile Credit Co., Ltd. .. .. .	215	F 4
British Pix Co., Ltd. .. .. .	211	G 4	Mica & Micanite Supplies, Ltd. .. .. .	154	H 2
British Rola Co., Ltd. .. .. .	41	B 1	Milnes Radio Co., Ltd. .. .. .	88	A 3
British Television Supplies, Ltd. .. .. .	47	B 1	Mullard Wireless Service Co., Ltd. .. .. .	72 & 161	B 4 & H 3
British Tungsram Radio Works, Ltd. .. .. .	36	D 2			
British Wireless for the Blind Fund .. .. .	46	B 1	<b>New London Electron Works, Ltd.</b> .. .. .	80	A 2
Brown Bros., Ltd. .. .. .	T. 18	G 1	Newnes, Geo., Ltd. .. .. .	10	D 3
Bulgin, A. F., & Co., Ltd. .. .. .	1	C 4			
Burndept, Ltd. .. .. .	85	A 3	<b>Odhams Press, Ltd.</b> .. .. .	T. 2	E 3
Bush Radio, Ltd. .. .. .	70	B 4	Olds Discount Co., Ltd. .. .. .	218	F 4
<b>Cadisich, R., &amp; Sons</b> .. .. .	T. 9	E 2	<b>Partridge, Wilson &amp; Co., Ltd.</b> .. .. .	29	D 4
Celestion, Ltd. .. .. .	26	D 3	Philips Lamps, Ltd. .. .. .	68	B 3
Chloride Electrical Storage Co., Ltd. .. .. .	32	D 4			
Cole, E. K., Ltd. .. .. .	69	B 3			
Collaro, Ltd. .. .. .	101	A 2			
Cosmocord, Ltd. .. .. .	48	C 1			
Cossor, A. C., Ltd. .. .. .	61 & 163	C 3 & H 3			
Crypton Equipment, Ltd. .. .. .	202	H 4			
<b>Davies, D. M. (Slough), Ltd.</b> .. .. .	16	D 1			
Davis & Timmins, Ltd. .. .. .	213	F 4			
Decca Gramophone Co., Ltd. .. .. .	71	B 4			
De La Rue, Thos., & Co., Ltd. .. .. .	6	D 4			
Department of Overseas Trade .. .. .	49	C 1			
Dew, A. J., & Co., Ltd. .. .. .	T. 20	G 1			
Dibben, Horace, Ltd. .. .. .	T. 8	E 2			
Dubilier Condenser Co. (1925), Ltd. .. .. .	81	A 2			
Dynaport Radio & Television, Ltd. .. .. .	18	D 1			
Dynatron Radio, Ltd. .. .. .	104	B 4			
Dyson, J., & Co., Ltd. .. .. .	T. 14	F 1			
<b>Eastick, J. J., &amp; Sons</b> .. .. .	T. 3	E 3			
East London Rubber Co., Ltd. .. .. .	T. 16	F 1			
Eavestaff, W. G., & Sons, Ltd. .. .. .	204	H 3			
Edison Swan Electric Co., Ltd. .. .. .	57	C 4			
Elf, Gordon, Ltd. .. .. .	95	A 1			
Everett, Edgcumbe & Co., Ltd. .. .. .	164	H 3			
Ever Ready Co. (G.B.), Ltd. .. .. .	58	C 4			
<b>Ferranti, Ltd.</b> .. .. .	21 & 74	D 1 & B 3			
Film Industries, Ltd. .. .. .	4	D 4			
Flinders (Wholesale), Ltd. .. .. .	T. 7	E 2			
Fuller Accumulator Co. (1926), Ltd. .. .. .	100	A 2			
<b>Gambrell Electrical Equipment Co., Ltd.</b> .. .. .	12	D 2			
Garrard Eng. & Mfg. Co., Ltd. .. .. .	37	D 1			
General Electric Co., Ltd. .. .. .	54 & 62	C 2			
Gilbert, C., & Co., Ltd. .. .. .	T. 17	G 1			
Goodmans Industries, Ltd. .. .. .	43	B 1			
Gramophone Co., Ltd. (H.M.V.) .. .. .	66 & 76	B 2			

### TELEVISION DEMONSTRATION ROOMS IN THE NATIONAL HALL (All prefaced TT)

- |  |                               |
|--|-------------------------------|
| 1 Radio Gramophone Development Co., Ltd. | 8 Baird Television, Ltd.      |
| 2 Cossor, A. C., Ltd.                    | 9 Ferranti, Ltd.              |
| 3 Cole, E. K., Ltd.                      | 10 General Electric Co., Ltd. |
| 4 Philips Lamps, Ltd.                    | 11 Kolster-Brandes, Ltd.      |
| 5 Marconiphone Co., Ltd.                 | 12 Ultra Electric, Ltd.       |
| 6 Pye, Ltd.                              | 13 Halcyon Radio, Ltd.        |
| 7 Edison Swan Electric Co., Ltd.         | 14 Gramophone Co., Ltd.       |

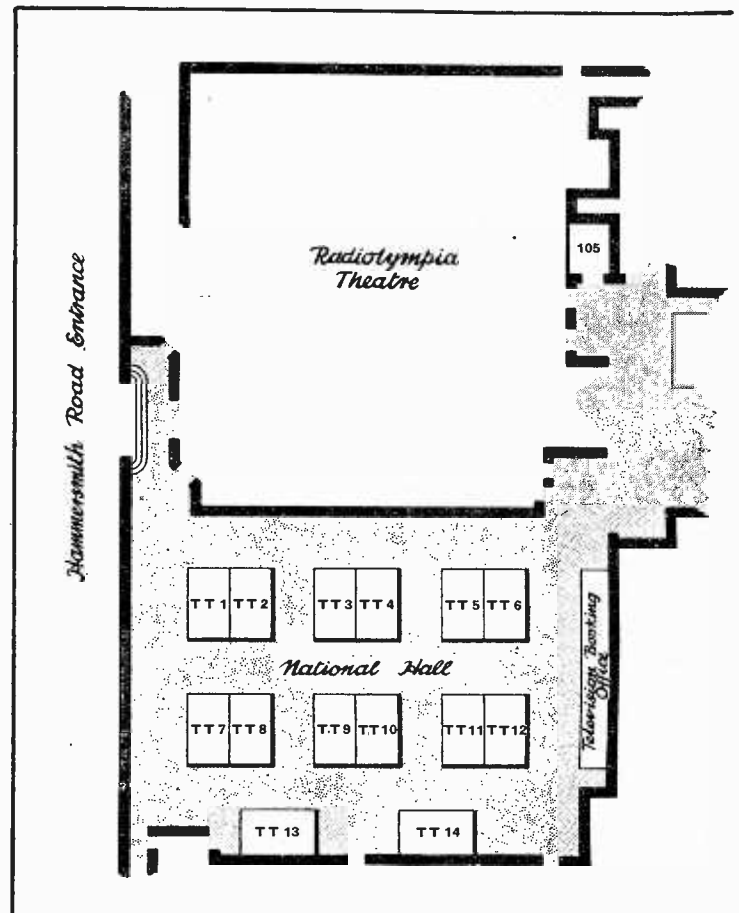



Name	Stand.	Reference.
Pilot Radio, Ltd.	84	A 3
Plessey Co., Ltd.	22	D 2
Pye, Ltd.	60	C 3
<b>Radio Gramophone Development Co., Ltd.</b>	67	B 2
Radiometers, Ltd.	162	H 3
Radio Society of Gt. Britain	214	F 4
Rawplug Co., Ltd.	91	A 2
Regentone Products, Ltd.	97	A 1
Reslo (Sound Equipment), Ltd.	24	D 2
Rist's Wires & Cables, Ltd.	159	H 1
Rose, Norman (Electrical), Ltd.	207	H 4

Name	Stand.	Reference.
<b>Salford Electrical Instruments, Ltd.</b>	168	H 2
Scott Insulated Wire Co., Ltd.	156	H 2
Selecta Gramophones, Ltd.	T. 13	F 1
Shaftesbury Microphones, Ltd.	92	A 2
Siemens Electric Lamps & Supplies, Ltd.	31	D 4
Sound Sales, Ltd.	89	A 2
Steatite & Porcelain Products, Ltd.	152	H 2
Sterling Batteries, Ltd.	5	D 4
Stratton & Co., Ltd.	23	D 2
<b>Tannoy Products</b>	86	A 4
Telegraph Condenser Co., Ltd.	38	C 1
Telsen Electric Co. (1935), Ltd.	90	A 2
Texaloom Radio, Ltd.	15	D 1
The 362 Radio Valve Co., Ltd.	210	H 4
Thompson, Diamond & Butcher	T. 5	E 2
Tucker Eyelet Co., Geo., Ltd.	102	A 3
<b>Ultra Electric, Ltd.</b>	63	C 2
<b>Varley</b>	99	A 2
Vidor, Ltd.	33	D 3
<b>Webber, J. M., &amp; Co., Ltd.</b>	T. 11	E 1
Westinghouse Brake & Signal Co., Ltd.	77	B 1
Weston Electrical Instrument Co., Ltd.	167	H 3
Whiteley Electrical Radio Co., Ltd.	75	B 2
Wingrove & Rogers, Ltd.	44	A 1
"Wireless & Electrical Trader"	T. 1	E 4
Wireless Retailers' Association	203	H 4
<b>Wireless World</b>	7	D 3
Wright & Weaire, Ltd.	165	H 3

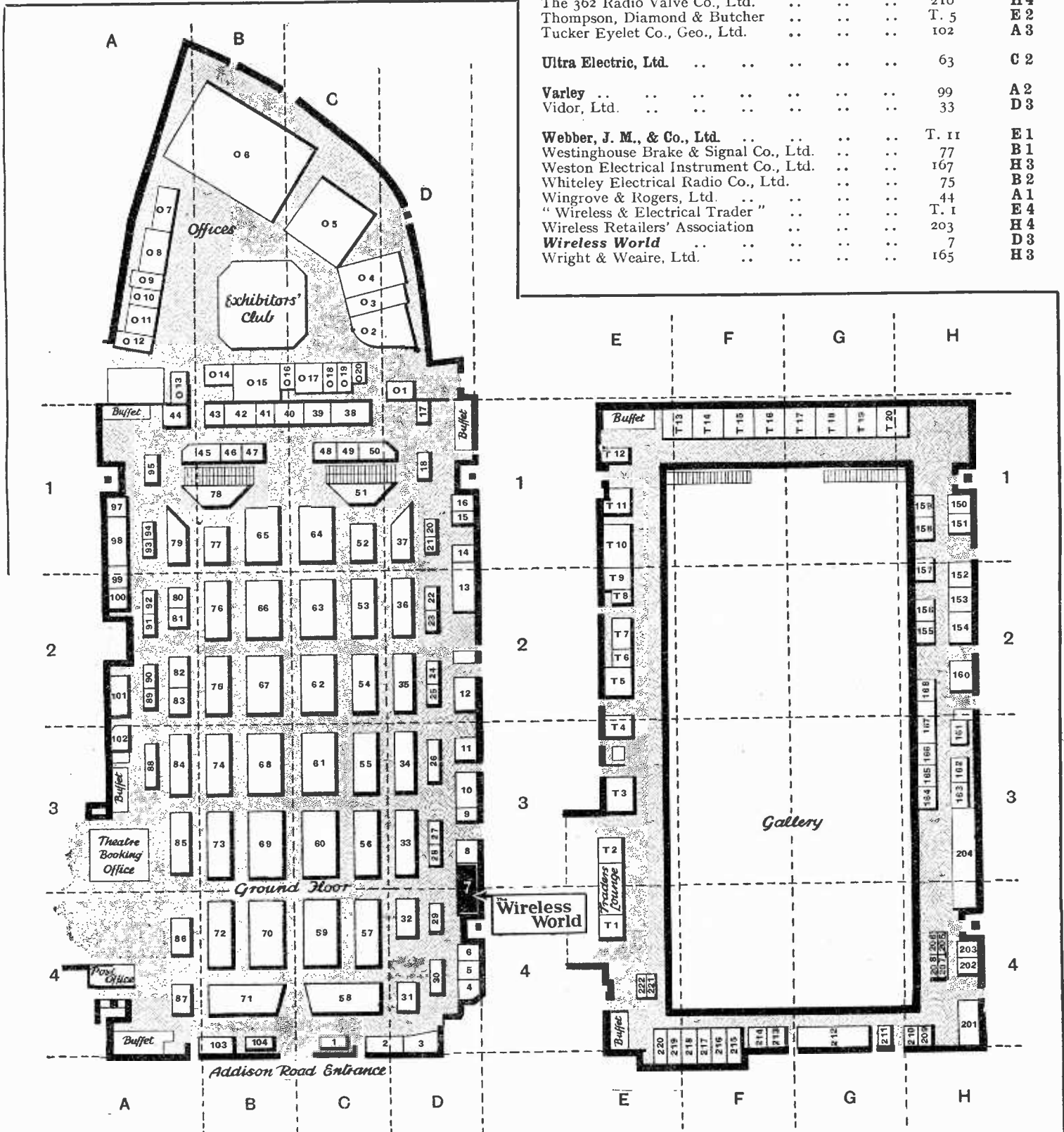

SPECIAL EXHIBITS: Radiolympia Museum, Stand 212 (Ref. G 4). G.P.O. Exhibit of Electrical Interference, Stand 98 (Ref. A 1). Any Stand in the Exhibition can instantly be located by using this squared plan in conjunction with the references shown in black type in the accompanying list of exhibitors.

# Recent Inventions

**Brief descriptions of the more interesting radio devices and improvements issued as patents will be included in this section.**

## TELEVISION RECEIVERS

**T**O prevent the "flyback" movement of the scanning beam in a cathode ray television receiver from making itself visible on the fluorescent screen, and so producing undesirable flashes across the picture, a momentary blocking voltage is applied to one of the amplifying valves in the set.

As shown in the figure, the scanning oscillator circuit consists of a condenser C which is charged up through a resistance R, and discharged through a valve V. A resistance R1 is inserted in series with the condenser C, and at the moment of discharge, when the "flyback" period starts, the voltage across R1 is applied through a condenser C1 to the grid of the amplifier A, thus momentarily blocking the passage of signal voltages to the cathode ray tube.

*C. Lorenz Akt. Convention date (Germany) August 23rd, 1935. No. 464610.*

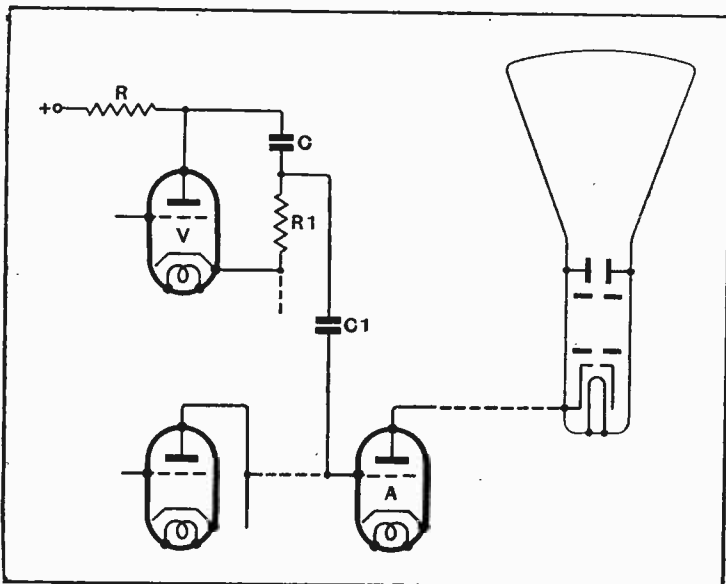

Method of preventing "flyback" lines of scanning voltages appearing on screen of television receiver.

## SUPER-REGENERATIVE AMPLIFIERS

**W**HEN a super-regenerative amplifier is used for receiving television signals, the quenching frequency is necessarily very high, since it must exceed the highest modulation frequency of the signals. But it is found that the circuit tends to become unstable when worked under these conditions.

Accordingly, other and more prolonged quenching periods are

superposed on that already mentioned. For instance, the circuit may be quenched during the "flyback" period between one scanning line and the next, and also during the whole of the similar "flyback" period separating one complete frame from the next. This allows the amplifier to be worked at the critical point of maximum efficiency, without "boiling over." A blocking circuit is interposed between the grid of the quenched valve and the pentode valve through which the quenching impulses are applied.

*Baird Television, Ltd., and D. M. Johnstone. Application date November 4th, 1935. No. 465276.*

## TIME-BASE CIRCUITS

**A** SAW-TOOTHED oscillation-generator for use in television is arranged so that it will operate either independently of any incoming synchronising impulses, for "straight" scanning, or be subject to their control in the case of "interlaced" scanning.

The plate and grid circuits of the oscillator valve are normally back-coupled, and, in this condition, the system is self-operative, because the valve discharges directly its anode potential reaches a certain value, irrespective of whether it is or is not triggered by

## RADIO NAVIGATION

**W**HEN a pilot is flying by wireless towards a beacon station B, he will normally take the straight line AB. But if there is a side wind in the direction of the arrow, its effect will be to drift

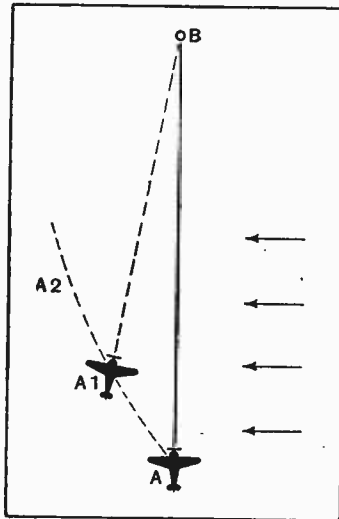

Diagram illustrating drift of an aeroplane in a strong side wind when flying towards a radio beacon B.

the plane over to a point A1, where the radio receiver indicates the course A1, B. A moment later the craft will be at A2, and so on, with the result that the actual course approximates more to a spiral than to a straight line.

The drift due to the wind can, of course, be offset by deliberately heading the plane into it, and the invention is concerned with a wireless method of correcting the steering accordingly. The pick-up from a frame aerial is combined with the pick-up from a vertical aerial, so as to give what would normally be a straight course. But in the presence of a side wind, a certain amount of damping is deliberately introduced into one of the aerial circuits by means of a resistance, which is calibrated in terms of the wind strength. This imparts a "bias" which enables the pilot to fly a corrected course whilst receiving normal signals.

*Telefunken Ges Fur Drahtlose Telegraphie M.b.H. Convention date (Germany) August 29th, 1935. No. 464740.*

## LOUD SPEAKERS

**T**HE effect known as "cabinet resonance" is due, at least in part, to sound energy radiated from the back of the diaphragm being returned in such phase as to accentuate the outgoing energy, thus giving rise to a "booming" effect. It is usually most notice-

able at the lower part of the speech range, where it tends to distort the natural sound of the spoken word. There are also "transient" resonance effects which produce what may be called an acoustic "hang over."

According to the invention these defects are eliminated by using a loud speaker fitted with a freely-movable or "floating" diaphragm, which is combined with other tuned diaphragms. The latter are used solely to absorb "undesired" sounds, and do not otherwise affect the reproduction of the received signals.

*Philco Radio and Television Corporation. Convention date (U.S.A.) June 17th, 1935. No. 465441.*

o o o o

## PIEZO-ELECTRIC CRYSTALS

**T**HE object of the invention is to cut a section of crystal which will oscillate freely at only one of a number of possible frequencies, and which, in addition, will maintain its frequency

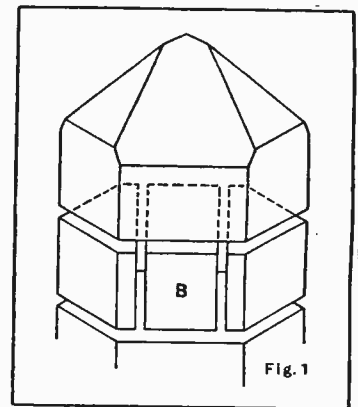

The block B is first cut from the mother crystal as shown here . . .

constant in spite of temperature variations.

Fig. 1 shows the manner in which a preliminary block B is cut out from the mother crystal, and Fig. 2 shows how the desired

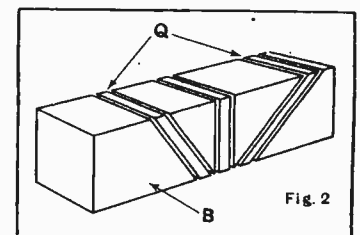

. . . and crystal elements Q are then cut from the block B in this manner.

crystal elements Q are cut at an angle from that block.

*Marconi's Wireless Telegraph Co., Ltd. (assignees of S. A. Bokovoy). Convention date (U.S.A.) September 30th, 1935. No. 464894.*

The British abstracts published here are prepared with the permission of the Controller of H.M. Stationery Office, from Specifications obtainable at the Patent Office, 25, Southampton Buildings, London, W.C.2, price 1/- each. A selection of patents issued in U.S.A. is also included.

# OLYMPIA SHOW REPORT

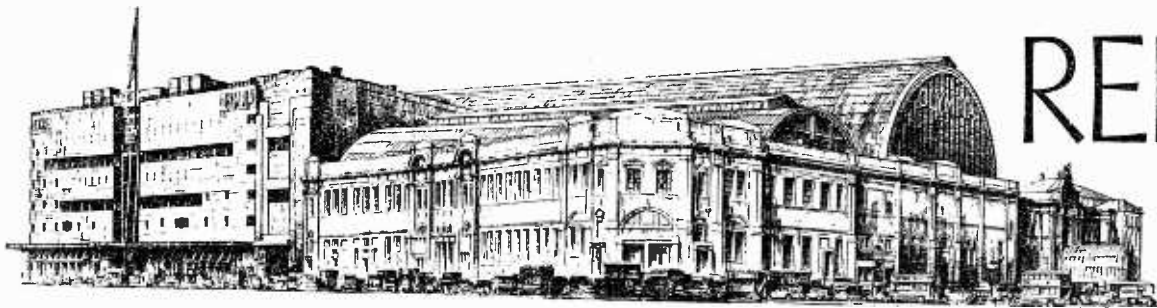

AUGUST 25th to SEPTEMBER 4th, 11 a.m.—10 p.m. DAILY

Each year "The Wireless World" compiles a full report of the Radio Show, in which the exhibits on individual stands are described. It is hoped that this review will be found a useful guide for visitors to Olympia, and that it will also serve as a permanent record of the activities of the British Wireless Industry for the season.

## ACE (103)

A frequency-changer comprising a pentagrid valve working in conjunction with a separate oscillator is one of the features of the Ace Model AW94, an AC receiver costing 15 guineas. The audio-frequency section is an ambitious one, embodying a triode phase-reversal stage and double triode valves in push-pull giving a rated output of 12 watts. This is a four-band all-wave set covering wavelengths from 11 metres upwards.

At the other end of the scale is a three-band superheterodyne costing 9½ guineas, and giving three watts from a pentode output stage; the latest British octal valves are used. In addition to other models there is a 9-guinea battery superheterodyne with pentode output.

*Ace Radio, 2-5, Dingley Place, City Road, London, E.C.1.*

## AERIALITE (28)

Among the many varieties of aerial made by this firm is an all-wave model which, complete, costs 17s. 6d. Motor car types, indoor and outdoor patterns and fittings of all kinds are available. In addition, they now have a long range of HT batteries and a short-wave converter covering 13 to 65 metres which costs £3. A carbon microphone and a moving-coil loud speaker in chassis and in cabinet form are also shown.

*Aerialite, Ltd., Castle Works, Stalybridge, Cheshire.*

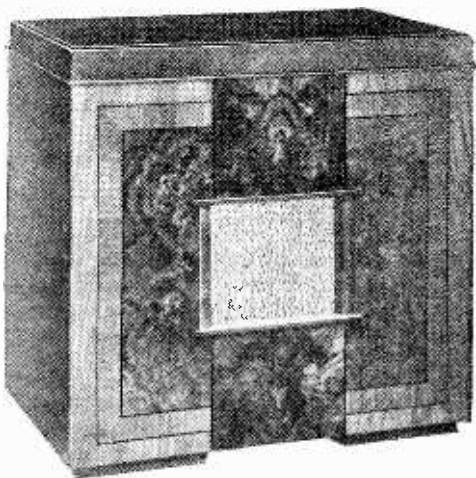

New Ace radiogramophone.

## AERODYNE (52)

The majority of this firm's new sets are all-wave models, this feature being included in the straight as well as in the superheterodyne models. Model 285 is a three-valve plus rectifier straight set with one R.F. stage and band-pass input and is AC operated. It has two short-wave bands, a medium and a long, and gives continuous tuning from 13 to 550 metres. The long-wave coverage is 700 to 2,000 metres. The power output is three watts. There is a model with a similar circuit for AC/DC operation.

Two short-wave bands are also included in the Model 291, which is a five-valve—including rectifier—superheterodyne for AC operation. This covers 13.7 to 141 metres in two ranges, 180 to 550 metres, and 750 to 2,000 metres on medium and long waves respectively.

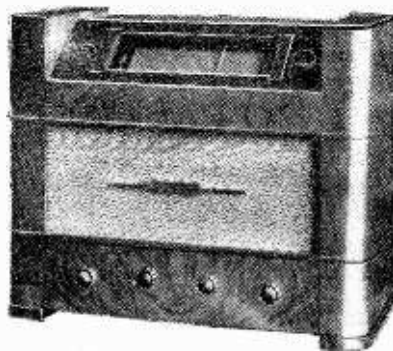

Aerodyne Model 290 all-wave superheterodyne.

Iron-cored coils are used in all the new Aerodyne sets, including the two battery-operated models.

*Aerodyne Radio, Ltd., Aerodyne Works, Tottenham, London, N.17.*

## ALBA (55)

Receivers fitted in armchair cabinets of an unusual design are one of the chief attractions on this stand. The controls are arranged horizontally in the top of the instrument and the loud speaker grille occupies the full vertical length of one of the corners of the cabinet. Cabinet models of this type are available with the receiver chassis used in the 815, 825 and 835 table models. The latter receiver has a very full specification including two short-wave ranges from 13-31 metres and 30-85 metres. The circuit includes an RF stage

## STAND-TO-STAND GUIDE TO THE EXHIBITS

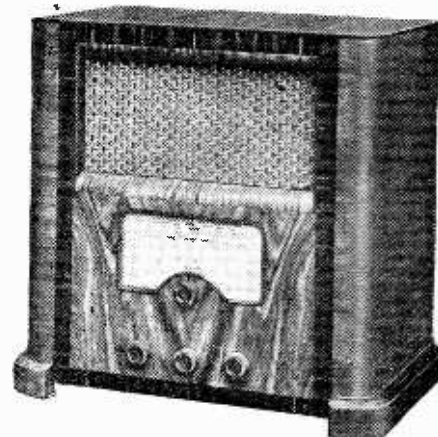

Alba Model 825 superheterodyne.

and a 3½-watt output pentode, and the price is 17 guineas for the table model and 22 guineas for the armchair console. AC/DC types are available at £1 extra in each case.

The Model 825 at 11 guineas in a table cabinet, and 16 guineas in the armchair console, has a single short-wave range going down to 16.5 metres. There is no RF stage, but a special valve in the output stage delivers 8 watts to the energised moving-coil loud speaker.

Visitors to this stand should also investigate the Model 650 all-wave superheterodyne in a vertical console cabinet at 12 guineas, and the 435 and 455 battery radiogramophones at 14 guineas and 18 guineas respectively.

*A. J. Balcombe, Ltd., 52-58, Tabernacle Street, London, E.C.2.*

## ALL POWER TRANSFORMERS (209)

Large and small mains transformers in a wide variety of types and for many different purposes are shown by this firm. A special feature is made of high-voltage models for CR tubes and television requirements. Two conversion units for AC to DC, giving DC outputs of 230 volts at 550 mA. and 275 mA. respectively, are also included.



**Olympia Show Report—**

This year vibrator units for obtaining HT from an LT accumulator are shown in three types and for 6- and 12-volt batteries. One is a synchronised-rectifier model, and gives a DC output of 250 volts at 70 mA.

A range of LT battery chargers and some small transformers for welding, brazing and soldering, complete an interesting exhibit of mains equipment.

*All Power Transformers, Ltd., 8a, Gladstone Road, Wimbledon, S.W.19.*

**ARDENTE (2)**

Including the new models, the present range of Ardenite power amplifiers and associated equipment is so complete that it would appear difficult to find an application which is not capable of being satisfied by the current models. Amplifiers for 10-,

15-, 20- and 100-watts output are now available, as well as mixing units, radio tuners, microphones and pre-amplifiers, loud speakers and gramophone equipment.

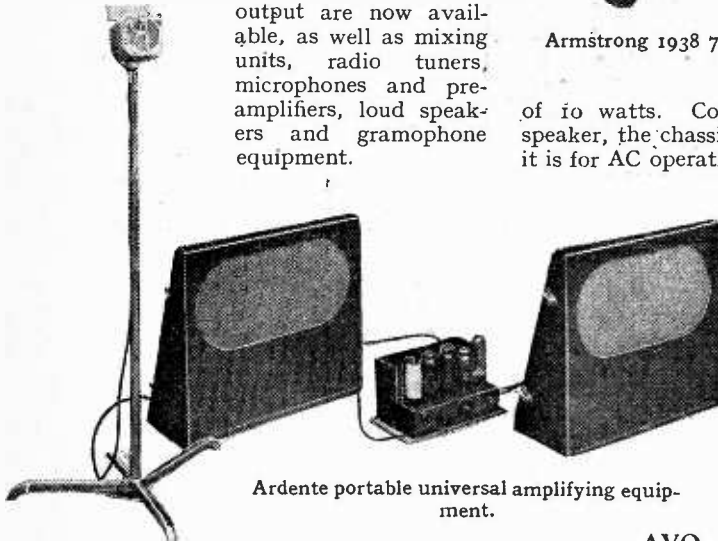

Ardente portable universal amplifying equipment.

The Model 615, a 6-volt operated amplifier, is designed for mobile work and gives 12-15 watts output. Carbon or moving-coil microphones can be used. Complete in every detail, it costs £25.

Portable amplifying equipment for AC or DC operation has been developed, the new Model 710 being one example. This gives 6 watts output, and has sufficient gain to operate at full output with a moving-coil microphone and the speaker several feet away. The amplifier, two loud speakers, microphone stand and accessories are contained in a demountable single carrying case, the whole weighing about 40 lb. Complete this costs 30 guineas.

Ardenite have introduced a series of loud-speaking inter-communication units for domestic and business use. They can be arranged either for two-way communication, when one master unit and one sub-unit is employed, or one master unit and several sub-units can be employed; or a system installed using master units at all points. This would enable all the points to communicate with each other. A master unit costs £12 12s., and each sub-unit £2 2s. It is an audio system.

*Ardenite Acoustic Laboratories, (R. H. Dent, Ltd.), 309, Oxford Street, London, W.1.*

**ARMSTRONG (220)**

Receivers in chassis form are being shown by this firm. One of the most interesting is the 1938 7-valve All-Wave Radiogram chassis. The receiver has three wavebands and tunes down to 17.9 metres; an RF amplifier is included and three stages are

controlled for AVC purposes. Octal-base valves are used and the output stage consists of push-pull triodes giving an output

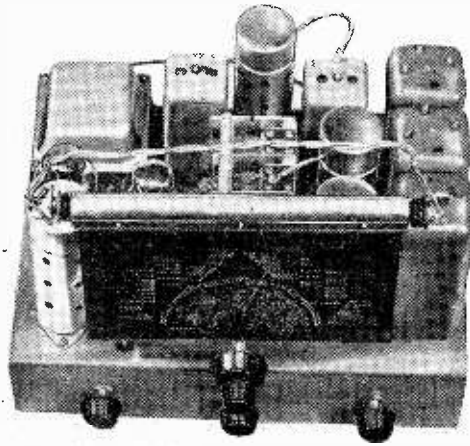

Armstrong 1938 7-valve all-wave radiogram chassis.

of 10 watts. Complete with valves and speaker, the chassis is priced at 10 guineas; it is for AC operation.

A similar receiver with an output of 4 watts obtained from a single triode is listed at 8 guineas, while another model having a 3½-watt tetrode output valve is priced at £7 10s.

*Armstrong Manufacturing Co., 100, King's Road, London, N.W.1.*

**AVO (30 & 166)**

With the addition of the new 46-range model, the range of Avometers now includes five different instruments, the DC Avominor being the cheapest at £2 5s., while the new Model 7 is the most comprehensive and costs £16 16s.

The Universal Avominor, costing £5 10s., provides twenty-two ranges, covering AC

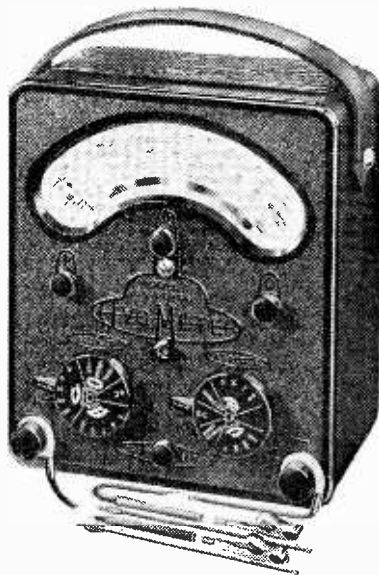

Model 7 46-range Universal Avometer.

and DC volts up to 500 and DC current up to 0.5 amp., as well as resistance measurements up to 10 megohms.

Servicing apparatus forms an important

section of this firm's activities. The latest addition to the range is the Avo Valve Tester, an instrument for testing valves by measuring the mutual conductance. An arbitrary scale, marked Good, Bad, and Doubtful, is also included. An AC-operated instrument designed to accommodate all valves in general use, it costs £11 11s.

The new Avo Oscillator, the price of which is now £6, is retained in much the same form as hitherto, and so also is the Avo Capacity Meter, the present price of which is £23. It is a battery-operated unit and has six ranges, each with a separate calibrated scale giving readings direct in mfd. It covers a range of capacities up to 0.1 mfd., the lowest range being calibrated at intervals of 5 mmfd. Measurements are made at a radio frequency of about 230 kc/s.

Avo also include among their products a kit of testing leads and other useful accessories.

*The Automatic Coil Winder and Electrical Equipment Co., Ltd., Winder House, Douglas Street, London, S.W.1.*

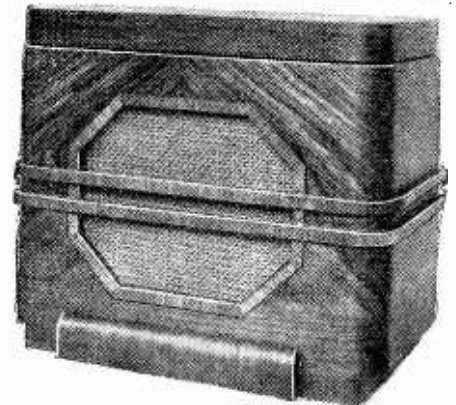

Beethoven battery superheterodyne trans-portable with concealed control panel.

**BAIRD (87)**

Pre-eminent among the exhibits on this stand are the Baird television receivers. The models T12 and T13 are superheterodynes and contain a 15-in. cathode-ray tube. This is mounted vertically and viewed through an inclined mirror carried inside the lid of the cabinet. The model T11 has a 12-in. tube which is viewed directly. Like the others, it includes an all-wave sound receiver. Magnetic focusing and deflection are used, and the tubes with the necessary scanning equipment are available separately.

The Multiplier photo-cell is on view in forms suitable for use with a concentrated light beam and for diffused light. The Multiplier is a chain of electron-permeable grid stages giving a current gain factor of the order of 100,000 times. The cathode sensitivity is about 30 microamps per lumen.

*Baird Television, Ltd., Greener House, 66, Haymarket, London, S.W.1.*

**BEETHOVEN (34)**

This firm is perhaps best known for portables, and several extremely interesting examples of this type of receiver appear on the stand this year. The "Super Baby" is, from many points of view, the most outstanding; though only a little larger than a box camera, it includes a moving-coil loud speaker, and weighs only about 12½ lb. Complete with 80-volt HT battery and a 14 AH jelly-acid accumulator, this is an

**Olympia Show Report—**

entirely self-contained set working on its own frame aerial; overall dimensions are  $9 \times 8\frac{1}{2} \times 5$  in.

A still more ambitious self-contained set is an AC/DC all-wave portable superheterodyne which needs no aerial or earth, even for short-wave reception. Although this is a mains-operated set, it weighs only 15 lb., and measures  $10\frac{1}{2} \times 10\frac{1}{4} \times 6$  in. By means of a Beethoven converter it can be operated from a car battery.

The range of Beethoven table models is notable for the fact that the control panel is mounted on the top of the cabinet and is concealed by a drop lid.

*Beethoven Radio, Ltd., Chase Road, North Acton, London, N.W.10.*

**BELLING-LEE (42)**

A new and important development of the firm of Belling and Lee is the inauguration of a scheme whereby the services of a staff of engineers trained in the suppression of electrical interference become available over the whole of the country. These specialists will deal both with interference at its source and at the receiving end.

So far as the listener is concerned, the most interesting exhibit is probably the "Eliminoise" anti-interference aerial, which remains substantially as before, though it has been strengthened mechanically, and its losses—low as they were—have been reduced. The "Eliminoise" is effective on all broadcast bands from 10 to 2,000 metres without serious loss of signal strength.

Set-lead suppressors—for inserting between the mains outlet and the receiver—and mains input filters are often surprisingly effective in eliminating certain forms of interference, and offer the advantage of very easy installation. The set-lead suppressors are made in various forms for receivers covering different wavebands.

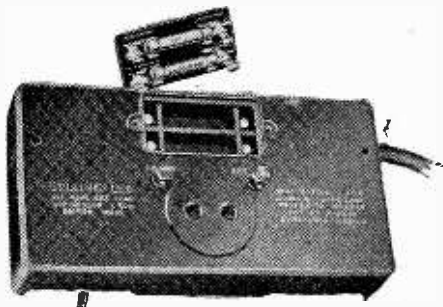

Belling-Lee set-lead suppressor for all-wave receivers.

Interference measuring apparatus constructed to official specifications is also shown, and there is a new noise locator, consisting of a portable receiver fitted with an exploring coil and headphones.

Television aerials, high voltage valve-holders for television receivers and connecting devices of various kinds for which the firm is well known are exhibited, together with the "Mag-Nickel" fuse, which affords protection to radio apparatus by virtue of its ability to resist switching-on surges.

*Belling & Lee, Ltd., Cambridge Arterial Road, Enfield, Middx.*

**BIFURCATED & TUBULAR RIVET CO. (151)**

Samples showing the type of work which can be undertaken with automatic riveting machines are displayed, and technical advice

is available on any problem involving the use of eyelets, etc.

*The Bifurcated & Tubular Rivet Co., Ltd., Aylesbury, Bucks.*

**BRITISH BELMONT (79)**

The receivers marketed by this firm include table models, radiogramophones, and a series of so-called "compacts" and portables. The Model 500 AC/DC compact covers medium and long waves and is suitable as a holiday receiver. The cabinet measures  $10\frac{1}{4} \times 6\frac{1}{2} \times 7\frac{1}{4}$  inches, and the weight of the set is only 7 lb. This receiver

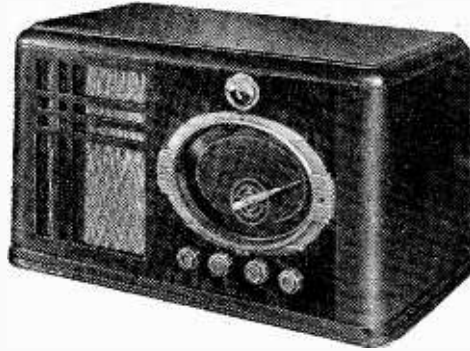

British Belmont Model 700.

can be supplied with a waterproof fabric cover cabinet provided with a carrying handle, and the price is £5 12s. 6d. The Model 700 all-wave AC superheterodyne at 13 guineas has already been reviewed in this journal. Its universal equivalent (Model 800) costs 13½ guineas, and there is a 9-valve table model (Model 900) at 18 guineas, which includes short-wave bands from 6.2-20 metres and 16-54 metres.

*British Belmont Radio, Ltd., 4-5, Ridge-mount Street, London, W.C.1.*

**BRITISH G.W.Z (82)**

Several additions have been made to the range of GWZ batteries, including a special group of heavy-duty HT units suitable for export. In addition to these special batteries, the exhibit comprises standard HT and grid-bias batteries, replacement batteries, single cells, Leclanche cells and sack elements.

*The British G.W.Z. Battery Co., Ltd., Falmouth Road Trading Estate, Slough, Bucks.*

**BRITISH METAL ENGRAVING CO. (158)**

This firm manufactures engraved scales and dials for many of the principal producers of broadcast receivers and, in addition, is showing name plates and transfers in various styles.

*British Metal Engraving Co., Ltd., St. Margaret's Works, St. Margaret's, Middx.*

**B.T.S. (47)**

All-wave receiver chassis in which a unit construction has been adopted are one of the main features of this firm's exhibit. They are available in 8-, 9- and 12-valve models and include an RF stage before the triode-hexode frequency-changer. There are two short-wave ranges and the output stage is push-pull with an output of 7 watts.

The *Wireless World* Straight Six with the Push-Pull Quality Amplifier is being shown, and there are also 7- and 14-watt resistance-coupled amplifiers. A high-fidelity loud speaker at 5 guineas in the DC model and £7 in the AC type is on view, as well as a

transverse current microphone at 2 guineas complete with stand and transformer.

A new portable receiver, the "Little Princess," at 8 guineas is prominently displayed and there is a wide range of components which includes shortwave coils and condensers.

A television receiver chassis is also exhibited. This employs a 12in. tube of the electrostatic deflection and focusing type. Gas-triodes are used in the time-base with balanced triode amplifiers for symmetrical deflection. The receiver is a superheterodyne with an RF stage and two triode-hexode frequency-changers. The vision channel has three IF stages, the last of which is push-pull, a diode detector and one VF amplifier, while the sound receiver has one IF stage, a duo-diode-triode detector and AF amplifier and a pentode output valve.

*British Television Supplies, Ltd., 8-10, Charing Cross Road, London, W.C.2.*

**BULGIN (1)**

Components of every conceivable kind are shown on this stand. Among the new models is a set of five-range coils, covering a waveband of 5 to 2,000 metres. All padding condensers are included, also the wave-change switches, though, unfortunately, it was stated in last week's issue that the switches were not included. A loose switch shaft is employed and several coil units can be ganged.

The aerial-coil unit, which can be used also as an RF transformer, costs 21s., and the oscillator model, which is for use with an IF of 465 kc/s, 30s.

There is a new range of screened coils in square cans and several different styles of 465-kc/s IF transformer to match. One is a variable-selectivity type and another has a reaction winding so that it could be used as a beat oscillator. The prices of these coils range from 5s. to 7s. 6d., according to type.

A complete new series of Electronic HT vibrators has been introduced. There are models for 4, 6 and 12 volts input. A universal-pattern vibrator transformer, which has a tapped primary winding to suit all the vibrators, is now available and it costs 20s. The 4- and 12-volt vibrators are the self-rectifying pattern and cost 20s. each; the 6-volt model requires a separate rectifier and costs 17s. 6d.

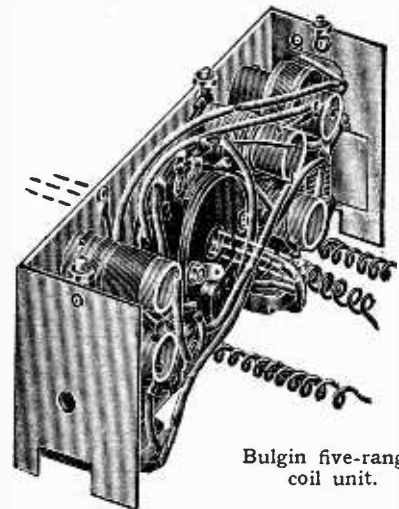

Bulgin five-range coil unit.

There is a range of new 5-watt wire-wound resistances, some high-voltage condensers—2,000 to 5,000 volts DC working—octal valve holders, two television di-pole aerials, and a host of other items.

**Olympia Show Report—**

In addition to components, Bulgin has designed a series of mains and battery sets which are available in kit form.

*A. F. Bulgin & Co., Ltd., Abbey Road, Barking, Essex.*

**BURNDEPT (85)**

An unusual output stage is used in the Burndept Model 259, in which 5 watts is obtained from a multi-electrode valve of the electron-coupled type. The circuit arrangement of this superheterodyne is an ambitious one, including a signal frequency

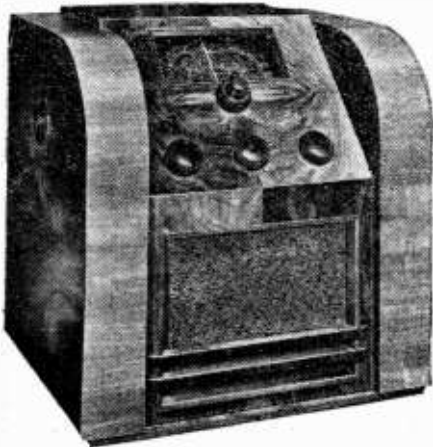

Burndept Model 259, with electron-coupled output valve.

stage, a triode-hexode frequency-changer, and a special pentode for intermediate audio-frequency amplification.

Another interesting model is the 257, a four-band superheterodyne with, like the preceding model, an unusual wave-range coverage. The bands are arranged as follows: 13.5-51 m.; 50-180 m.; 175-580 m.; 750-2,000 m. Thus, coverage is complete except for a short gap on the "shipping" band. Both battery and mains version of this superheterodyne are priced at 10½ gns.; features of this design include Litz-wound iron-cored coils throughout, and, in the battery version, a separate triode oscillator with a hexode frequency-changer.

There are also battery and AC/DC trans-portables and four-band "straight" sets.

*Burndept, Ltd., Light Gun Factory, Erith, Kent.*

**BUSH (70)**

One of the most ambitious of the Bush

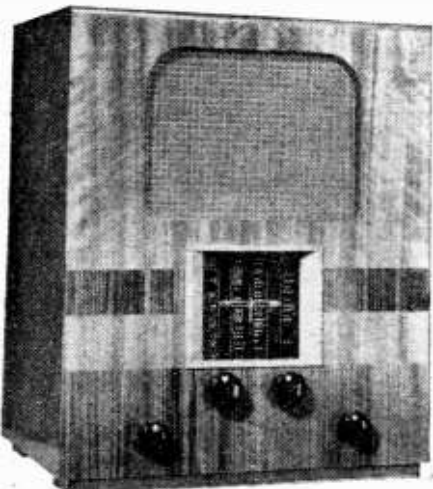

Bush Radio all-wave superheterodyne.

table models is the SW45, a five-valve AC superheterodyne with seven tuned circuits covering wavelengths between 16.5 and 2,000 metres in three steps. Variable selectivity is provided, and the exceptionally large output of 5 watts is obtained from a pentode valve. The cabinet is a specially large one and is planned on unusual but pleasing lines. The SW45 costs 15 gns.

Another recently introduced AC set is the SW43, a seven-stage superheterodyne with seven tuned circuits. This also gives an output of 5 watts and is available either as a table model, a console, or a radio-gramophone, with or without automatic record changing.

A low-priced all-wave AC superheterodyne is the SW41, again a three-band set, which costs 10 gns. By use of the inverse feed-back principle, an output of 3½ watts is obtained from a pentode valve.

Baird television receivers manufactured by Bush Radio are also shown on this stand; these have already been described in some detail elsewhere in this issue.

*Bush Radio, Ltd., Power Road, Chiswick, London, W.4.*

**CELESTION (26)**

A wide range of high-grade extension speakers in chassis and cabinet form is shown on this stand. All models are supplied without transformer for use with receivers with outputs from 1-5 ohms, but they may also be obtained with the Celestion universal transformer. The Standard Eight, Junior Auditorium and Standard Auditorium PM cabinet models incorporate a constant

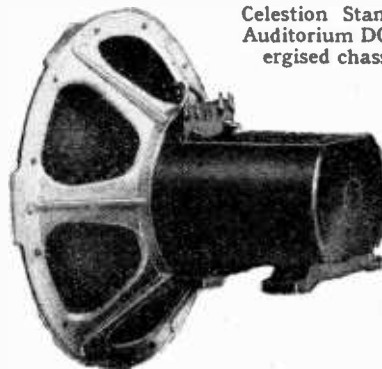

Celestion Standard Auditorium DC energised chassis.

impedance volume control, and their prices are £3 5s., £4 5s., and £6 without transformer. Attention is also drawn to the Standard Auditorium Energised Chassis which is available for all standard values of field resistance and costs £5 without transformer. A special transformer (Type SA967) is supplied for use with this speaker at 15s.

*Celestion, Ltd., London Road, Kingston-on-Thames, Surrey.*

**CLIX (94)**

The range of plugs, sockets and connectors made by this firm has been extended and several new items introduced. Among these is a combined crocodile clip and socket intended primarily for service work. It costs 4½d. Another useful item is a combined plug and socket which has the plug at right angles to the socket part. The price of this is 2½d.

Insulated strips fitted with sockets for mounting on metal chassis are now made in several different patterns. Two-, three- and four-socket strips for aerial and earth connections, output connections, and for mains input are also shown, together with a

selection of plug adaptors, wall plugs and two-pin mains plugs embodying fuses. The last mentioned costs 1s. 3d.

Clix also make a long range of valve-holders, some of which are designed especially for short and ultra-short wave use.

*British Mechanical Productions, Ltd., 79a, Rochester Row, London, S.W.1.*

**COLLARO (101)**

The "Letter Box" form of record-changer made by this firm is now available in either chassis or cabinet form, the price of the former being £6 18s. 6d. for the AC model and £7 5s. for the universal type.

Collaro AC37 motor on beaded edge unit plate.

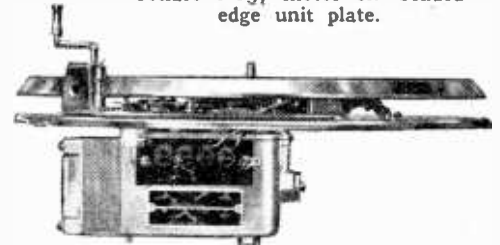

The Collaro automatic record-changer at 10 guineas for AC and £11 16s. 3d. for universal mains, is again being shown. It plays eight 9-inch, 10-inch and 12-inch records in any order. Magnetic and crystal pick-ups, electric and spring gramophone motors and complete radiogram units are also shown by this firm.

*Collaro, Ltd., Culmore Works, Culmore Road, Peckham, London, S.E.15.*

**COSMOCORD (48)**

The two principal exhibits on this stand are the Model 84 portable gramophone unit and the Model 25 high-fidelity pick-up. The latter has been specially designed with low damping to give reduced record wear and is fitted with an aluminium-nickel alloy magnet. The output is for 1 v. at 1,000 c/s, and the price is 25s.

The Model 84 gramophone unit is designed as an extension to existing receivers, and makes use of the Model 25 pick-up. With an AC motor the price is £3 10s., and models with AC/DC and spring motors are available at £4 5s. and £3 5s., respectively.

*Cosmocord, Ltd., Cambridge Arterial Road, Enfield, Middx.*

**COSSOR (61 & 163)**

Among the wide range of receivers to be found on this stand the Model 584 is of par-

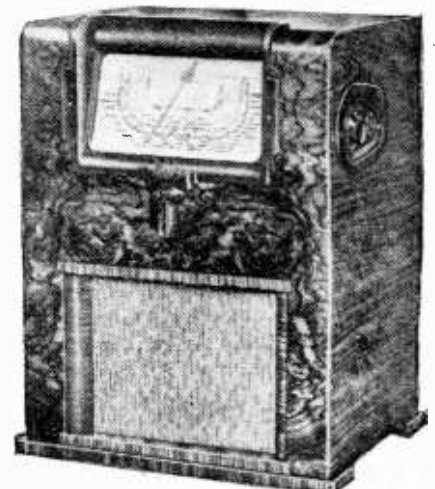

Cossor Model 484 3-valve all-wave receiver.



**Olympia Show Report—**

ticular interest in view of the inclusion of variable selectivity. The receiver is a superheterodyne with a triode-hexode frequency-changer and one IF stage; a duo-diode-triode acts as detector and AF amplifier as well as providing AVC. The waverange is 16-52.2, 196-566, and 968-2,050 metres. Fixed condensers are used in the IF transformers, trimming being effected by varying the iron cores of the coils, and the coupling

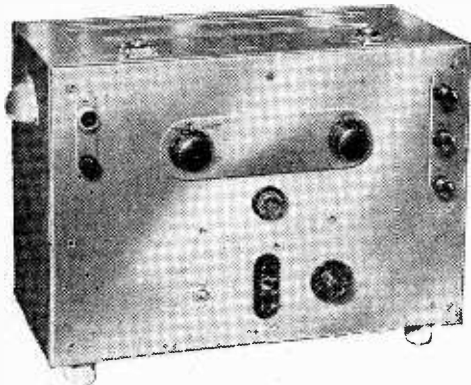

Cossor Paraphase amplifier for oscillograph use.

between the coils of one transformer is adjustable for variable selectivity. The set is designed for AC operation and costs 13 guineas. Models for AC/DC and battery operation are also available as well as a radio-gramophone.

A smaller receiver is the 484 at £9 19s. 6d. This is again an all-wave set of the superheterodyne type, but has no IF stage, adequate sensitivity being obtained through the use of a regenerative detector.

Television receivers are also being shown and the model 137 has a superheterodyne vision receiver designed for single-sideband working. A 12-in. cathode-ray tube is included and viewed directly. CR tubes of all types from the large high-vacuum models for television to the small gas-focused types for oscillograph purposes are shown. Valves, too, are naturally an exhibit of this firm.

Cathode-ray oscilloscopes and a ganging oscillator are to be found and in combination permit the visual inspection of resonance curves and so greatly facilitate the adjustment of receivers. In addition, a number of special amplifiers is on view, including a paraphase DC amplifier with a response extending up to 100,000 c/s.

A. C. Cossor, Ltd., Cossor House, Highbury Grove, London, N.5.



Crypton three-circuit battery charger.

**CRYPTON (202)**

The latest addition to the battery-charging equipment in which this firm specialise is a range of chargers for AC mains operation and which embody a new type of rectifying valve. Over twenty models are included in this series, and every possible requirement can be satisfied.

A valuable feature of these units is their accessibility, for all models are fitted with hinged front panels.

Crypton Equipment, Ltd., North Acton Road, Park Royal, London, N.W.10.

**DAVENSET (29)**

Battery chargers for both AC and DC mains are featured on this stand together with the necessary accessories for an efficient charging station. Special stress is laid upon the fitting of magnetic overload protection gear, moving coil meters, and enclosed rotary packet switches.

Partridge, Wilson & Co., Ltd., Davenset Works, Evington Valley Road, Leicester.

**DAVIES WOODWORK (16)**

Representatives of this well-known firm of woodworkers are available to discuss the particular problems of trade enquirers.

D. M. Davies (Slough), Ltd., Trading Estate, Slough, Bucks.

**DAVIS & TIMMINS (213)**

Screws of every conceivable type are shown on this stand, and special attention is directed to the high-grade rolled thread screws and to the scheme for delivery by return post of certain specified "in-stock" lines.

Davis & Timmins, Ltd., Brook Road, Wood Green, London, N.22.

**DECCA (71)**

All the new receivers and radio gramophones in the Decca and Brunswick series shown by this firm have one or more short-wave ranges, while some cover the ultra-short waves as well.

The Brunswick BGA/3 radio gramophone, an AC superheterodyne, has tuning ranges of 5 to 12, 12 to 35, 35 to 100, 200 to 550 and 1,000 to 2,000 metres. It is a 10-valve model, gives 12 watts output, includes variable selectivity control and costs 35 guineas. A similar model with an automatic record changer costs 42 guineas.

One of the smallest sets in the Decca series is a three-valve straight battery set having one RF stage and covering wavebands of 19 to 49, 200 to 550 and 1,000 to 2,000 metres. A PM moving coil speaker is fitted and the price is 7½ guineas.

In both the Brunswick and the Decca series are sets for battery operation, some being portables, as well as table models and radio gramophones.

The Decca Gramophone Co., Ltd., 1-3, Brixton Road, London, S.W.9.

**DE LA RUE (6)**

This exhibit is made up of a comprehensive display of plastic mouldings as used by the radio industry. Particular attention should be drawn to the large moulded cabinets that are shown, as well as to various radio components made by the injection moulding process in cellulose acetate and other special materials.

Thos. De La Rue & Co., Ltd., 90, Skernhall Street, London, E.17.

**DUBILIER (81)**

Among the new condensers introduced by Dubilier is a range of ceramic dielectric condensers which are shown in a wide variety of capacities. With this particular form of construction very small capacities—a few m-mfds. or so—can be made and their capacities are ostensibly constant under quite widely different climatic conditions. Another new series is the silvered mica condensers.

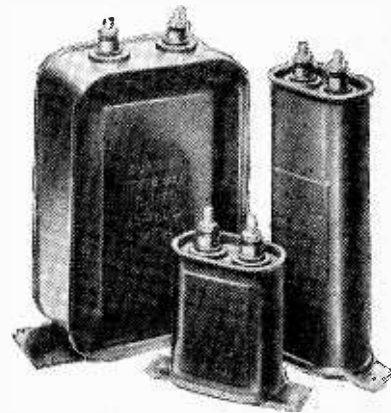

Group of Dubilier oil-immersed high-voltage condensers.

The non-inductive tubular paper condensers can now be supplied with either end or side connecting wires, and some models for high-voltage operation are available.

The range of oil-immersed paper condensers has been extended, and now includes models for a working potential of 6,000 volts.

A 16-mfd. 500-volt DC working condenser has been added to the wet electrolytic series; known as the Type F2920, it costs 7s.

To the range of dry electrolytics has been added three new models with the Type No. 3016. These are 10 mfd. 70 volts; 12 mfd. 50 volts; and 2 mfd. 250 volts working DC potential, the prices being 2s. 3d. in each case.

Dubilier Condenser Co. (1925), Ltd., Ducon Works, Victoria Road, North Acton, London, W.3.

**DYNATRON (104)**

The main feature of the receivers shown by this firm is that they operate as superheterodynes or as straight sets, according to the degree of selectivity desired. They are all-wave sets, with five tuning ranges, extending down to 6½ metres, and an RF stage

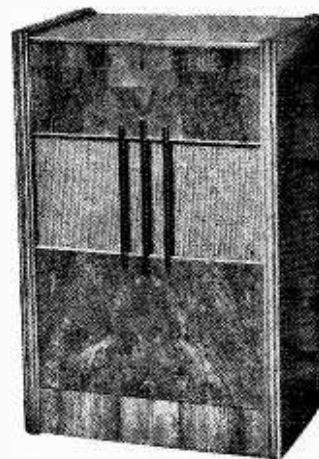

The Dynatron Ether Knight.



**Olympia Show Report—**

is operative on all wavebands. Variable selectivity is included, and in the position of lowest selectivity this control converts the circuit from a superheterodyne to a straight set.

The largest model is the Ether Empress Radio-gramophone. A separate Voigt loud speaker is used, and the set has a total of 17 valves and 14 tuned circuits, on eight of which the variable-selectivity control operates. The output of the double push-pull AF amplifier is 15 watts, and the equipment is listed at 155 guineas. Models using the same receiver, but a built-in loud speaker, are available at 115 guineas.

The Ether Knight has an 8-watt output stage. It is an all-wave receiver having five wavebands and variable selectivity. It is priced at 43 guineas.

*Dynatron Radio, Ltd., Perfecta Works, Ray Lea Road, Maidenhead, Berks.*

**EDDYSTONE (23)**

In addition to a range of receivers covering the requirements of ultra-short, short- and all-wave reception, Stratton are showing a very full range of components designed especially for use in short- and ultra-short wave receivers.

Several new items of interest to the amateur experimenter have been introduced, among these being a series of transmitting condensers with very rigid vanes and insulated either with Frequentite or with DL9 material.

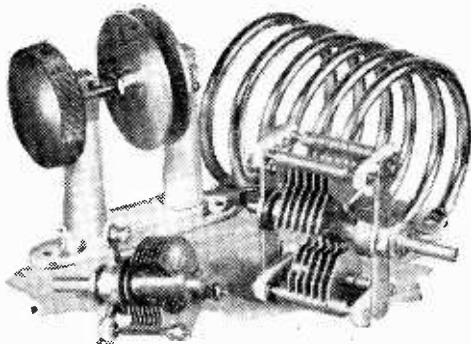

Selection of Eddystone short-wave components.

They are made in 40- and 100-m-mfds. sizes and, as a split stator condenser, with a capacity 50 m-mfds. per section. Prices range from 14s. 6d. to £1 12s.

Short-wave valve holders with Frequentite bases, trimmer condensers, a long range of small-capacity variables, ultra-short wave coils, IF transformers and a host of other items for short-wave use are made by this firm.

There is a range of welded steel cabinets for small sets and other apparatus, also a rack assembly of trays with panels made in steel and which can be used for assembling transmitters, modulating amplifiers, etc. A 4-tier model costs 37s. 6d.

*Stratton & Co., Ltd., Eddystone Works, Bromsgrove Street, Birmingham, 5.*

**EDISWAN (57)**

The range of Mazda valves has been extended by a number of new types. One of the most interesting of these is the AC/SP3; it is an RF pentode of high mutual conductance—no less than 7.6 mA/v—designed for use in television receivers. Fitted with the standard 7-pin base, it has a top-grid connector and consumes about 16.8 mA

for screen and anode currents together. A new diode, the D1, is also shown. This is also intended for television apparatus, and to keep capacity down to a minimum it is unbased so that it can be suspended in the wiring.



Mazda AC/P4 triode for time-base work.

For time-base use there is the AC/P4, a triode with a top-anode connector which is intended for use at high voltage, and there is, of course, the well-known range of Thyratrons. Of these, the T20 is recommended for use with magnetic deflection circuits in view of the low voltages usually adopted.

The range of cathode-ray tubes has been extended by the addition of the 9MH and 12MH. These are 9in. and 12in. television-type tubes designed for magnetic deflection and focusing. They have indirectly-heated cathodes and the single anode requires up to 6,000 volts. The well-known range

of tubes operating with electrostatic deflection and focusing is also shown.

In addition to valves and CR tubes, moving-coil loud speakers are on view, and pick-ups of both the needle-armature and pick-up-electric types are exhibited.

*The Edison Swan Electric Co., Ltd., 155, Charing Cross Road, London, W.C.2.*

**EELIX (T.3)**

Eelix specialties such as testing prods, terminals, plugs, etc., are shown on this stand, together with a range of short-wave converters. There are three models in the series, the A2 for use with AC mains sets and costing £4 14s. 6d., and the BM model. This is for battery as well as for AC sets and costs £1 19s. 6d. less valve. The largest model is the M2 Super, fitted with two valves and its own power supply unit. Complete it costs £8 15s.

In addition the proprietary products handled by this firm are shown.

*J. J. Eastick & Sons, 118, Bunhill Row, London, E.C.1.*

**EKCO (69)**

Convenience of operation has clearly been given much thought in planning the new Ekco sets; the "spin-wheel" tuning drive



Ekco lightweight portable.

included in several new models is certainly very pleasant to operate, and it also makes for an exceptionally neat appearance. The

most advanced chassis in which this method is employed is that of the AW98 AC mains superheterodyne, a nine-stage receiver with a triode-hexode frequency-changer and a pentode output valve giving 6 watts with the help of the inverse feed-back principle. Wave-range coverage is exceptionally wide, the television sound channel being included. The price of this set is 15½ gns.; a battery version of it, with QPP output, costs 13 gns. without batteries.

The "spin-wheel" system is also included in a lower-priced all-wave AC superhet at 12½ gns., but a more conventional control system is used in the 16½-gn. Model AW108, a nine-stage AC superheterodyne which is stated to have an extended frequency range of from 40 to 8,000 c/s.

In addition to these receivers, there are several simpler "straight" and superhet models. The "No HT" battery-set idea has been elaborated this year by the production of an all-wave model; as most readers will know, the anode current supply of this receiver is derived from the LT battery through the intermediary of a vibratory step-up generator.

Finally, there is an entirely new portable set of very practical and convenient shape, which includes a TRF three-valve circuit, and, with a total weight of 17 lb., costs £7 19s. 6d. complete.

*E. K. Cole, Ltd., Ekco Works, Southend-on-Sea, Essex.*

**ELECTRON (80)**

Aerial equipment of all kinds, including wire, insulating pins and screened aerials, comprises the exhibit of this firm. The

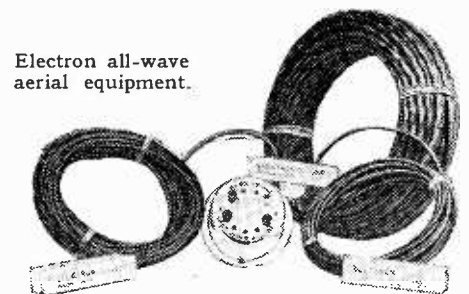

Electron all-wave aerial equipment.

Electron long-distance aerial is of the all-wave type and is supplied with a variable transformer for matching the impedance of the various types of receiver.

*The New London Electron Works, Ltd., East Ham, London, E.6.*

**ELF (95)**

All the receivers shown by this firm are self-contained portable superheterodynes operating on built-in frame aerials; battery and AC/DC models are produced. The "Cameogram" is a two-band portable AC/DC radio-gramophone, priced at 15 guineas, while the "Spencer" AC/DC table model covers a waverange of 10-2,000 metres in four steps and costs 12½ guineas.

*Gordon Elf, Ltd., 17a, Hanover Square, London, W.1.*

**EVER READY (58)**

Receivers, batteries and valves are shown by this firm. Three-valve straight sets are shown and are of the RF-det.-pent. type. The 5028 battery model is listed at 6 guineas and the AC model 5027 is priced at 7 guineas. Moving-coil loud speakers are fitted.

A small superheterodyne, model 5029, is

**Olympia Show Report—**

shown. This commences with a triode-hexode frequency-changer which is followed by an IF stage, and, in turn, by a duo-diode-triode which feeds the output pentode. In addition to the medium and long wavebands, this set covers 18-50 metres on the short waves. A similar battery model is available, but this has a heptode frequency-changer and the duo-diode-triode is followed

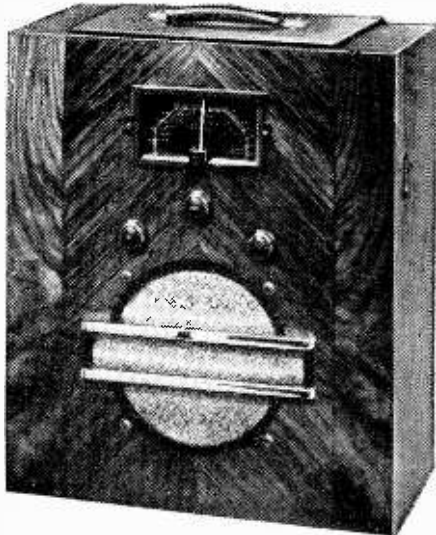

Ever Ready portable battery receiver, Model 5035.

by a driver and Class B output stage. Both models are listed at £11 15s. A larger super-heterodyne with two short wave-ranges is shown. This is the model 5025 at 18 guineas, and it tunes down to 13 metres.

There is also a battery portable receiver, 5035, at 10 guineas. This is a straight set with a Class B output stage and covers the normal broadcast bands.

*The Ever Ready Co. (Great Britain), Ltd., Hercules Place, Holloway, London, N.7.*

**EXIDE & DRYDEX (32)**

New tendencies in battery set design are always reflected in the Exide programme; an example of this was recently made

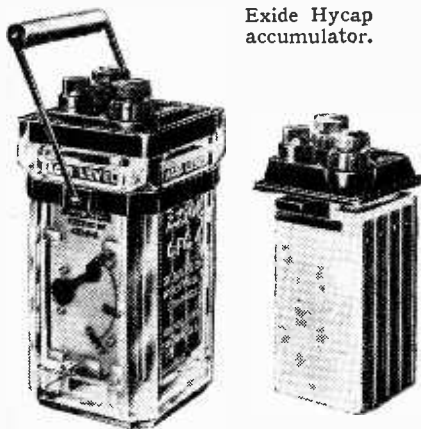

Exide Hycap accumulator.

evident by the introduction of LT accumulators designed for a higher current output than that of the "mass" type which was so popular a few years ago. The recently introduced "Hycap" LT accumulators are specially designed to meet the current demands of the modern set. These cells, which are of the glass type, include a simple and effective form of charge indicator.

Exide unspillable cells, suitable in capacity and shape for the midget portable receivers that are now so popular, are also a recent

introduction. HT accumulator batteries have recently been improved by the fitting of an anti-leakage shield round the terminals.

New models of Drydex HT dry batteries for recent sets have been introduced, and, in addition, alternative batteries for a number of popular sets are shown. The use of protective cardboard sleeves to prevent damage to batteries in transit has been extended.

*The Chloride Electrical Storage Co., Ltd., Clifton Junction, near Manchester.*

**FERRANTI (21 & 74)**

Although its circuit arrangement is at first sight fairly conventional, the Ferranti Model 1737 is in many respects an unusual receiver. It includes variable selectivity, and, as even the most practised user is likely to forget to set this adjustment at "selective" before beginning to search for stations, this responsibility is taken over by an ingenious automatic mechanical device which returns the inter-circuit coupling to minimum as soon as the tuning knob is rotated. A triode output valve is employed, and special pains are taken to do

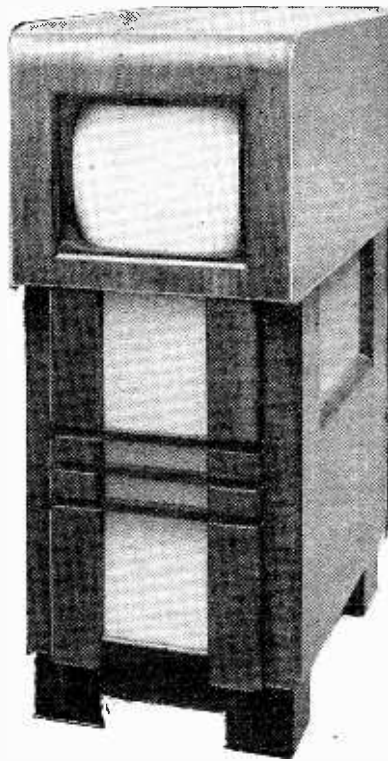

Ferranti Television Receiver.

justice to this stage by fitting a special speaker. An exceptionally good bass response is claimed, and it is stated that the upper register is well maintained up to 8,000 c/s. An improved "Magnascopic" tuning scale is provided as an aid to short-wave work. This is a three-band set costing 17 guineas. A well-planned console version of the same set costs 20 guineas.

In addition to two TRF sets there are seven-stage battery superheterodynes with QPP output at 11 guineas and 12½ guineas, and an inexpensive three-band AC superhet with iron-cored signal frequency coils which costs 9 guineas.

Covering the television sight and sound channels only, the Ferranti television receiver uses a 15-inch tube and gives a directly viewed picture measuring 11¼ x 9 ins. Focusing and scanning are magnetic, while all the eight control knobs are concealed under panels.

A six-valve car radio set has also been introduced in the form of a two-unit super-heterodyne arranged for remote control; one of the units comprises the set proper, while the other contains the speaker and vibratory HT generator. Without aerial or installation charges, this model, which requires no plug suppressors, costs 13½ guineas.

A new booklet giving full technical information about Ferranti components is available on the stand.

*Ferranti, Ltd., Radio Works, Moston, Manchester.*

**FILM INDUSTRIES (4)**

A new loud speaker unit, capable of handling 35-40 watts, has been added to the range of horn-type FI loud speakers. This is the Type LS8, which is provided with a non-metallic diaphragm and is priced at £10. It is designed for use with a 70-inch exponential horn, which also costs £10. The Type LS7 unit now replaces the LS6. It has a power handling capacity of 10 watts and is suitable for use with a 40-inch horn.

Cone-type loud speaker for domestic use with parallel-action centring device and sealed air gap, and a series of amplifiers with rated power outputs of 3½ watts upwards, are also shown on this stand.

*Film Industries, Ltd., 60, Paddington Street, London, W.1.*

**FULLER (100)**

A wide range of accumulators of both the ordinary and the unspillable types is shown on this stand. HT accumulators are also in evidence, as well as dry batteries, which are available in the standard types in addition to the special portable series.

*Fuller Accumulator Co. (1926), Ltd., Woodland Works, Chadwell Heath, Essex.*

**G.E.C. (54 & 62)**

Prominent among the receivers on this stand is the AC All-Wave Super 6, which is available in a variety of cabinet styles. The receiver in radio-gramophone form is priced at 26 guineas. It is a superheterodyne with one signal-frequency amplifier, a triode-hexode frequency-changer, and one IF stage; a duo-diode-triode is used as detector and AF amplifier, and there is a tetrode output valve. Three wavebands are included, the short wave-range being 16.5-51 metres. Iron-cored coils are employed.

Special attention has been paid to the cabinet work, which has unusually clean



G.E.C. AC All-wave Super 6 Radiogram.

**Olympia Show Report—**

lines. There is only one external control—the combined volume control and on-off switch—the others being concealed beneath the cabinet lid.

A wide range of Osram valves is naturally on view, and the new International series is prominently displayed. The valves in this series are fitted with the American-type Octal bases, and in most cases their characteristics are identical with American models. The heater rating is 6.3 volts at 0.3 ampere, and the valves are suitable for AC, AC/DC, or car-battery operation. The range includes specimens for all stages of a receiver.



Osram KT66 power output tetrode.

Output pentodes are being replaced by tetrodes of improved characteristics. Means have now been found of eliminating the negative - resistance kink of a tetrode without having to introduce a suppressor-grid, and somewhat straighter characteristics are obtained.

A number of special valves ranging from an Acorn pentode for ultra-short wave working to transmitting types is to be found. Television receivers are also on view.

*The General Electric Co., Ltd., Magnet House, Kingsway, London, W.C.2.*

**GARRARD (37)**

The centre of interest on this stand is the new RC1A automatic record-changer. It works on the same principle as the RC1, with three record supports arranged round the periphery of the turntable, but in this case the adjustment of the release mechanism is made automatically, and the unit will play up to eight 10-inch or 12-inch records mixed in any order. The price of the new RC1A unit is £10 with an induction-type AC motor, or £10 17s. 6d. with a motor of the universal type. The RC4 record-changer with bent record spindle at £7 10s. for AC mains only is shown together with a very wide range of spring and electric turntables and complete radiogram units.

*The Garrard Engineering & Manufacturing Co., Ltd., Newcastle Street, Swindon, Wilts.*

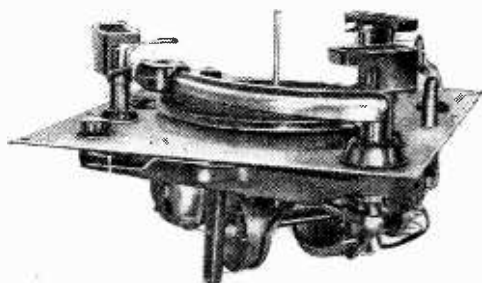

Garrard RC1A record-changer.

**GOODMANS (43)**

In addition to the 10-inch and 12-inch high-fidelity Auditorium reproducers for which this firm is noted, the new duplex horn PA loud speaker of the horizontal projection type will be found on this stand.

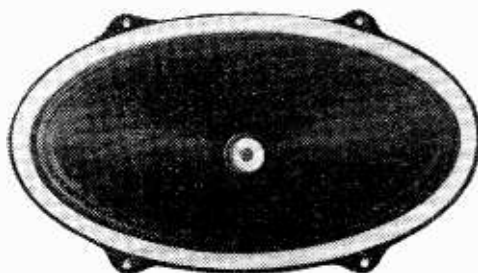

Goodmans' elliptical cone loud speaker.

The unit is designed to handle 12 watts peak AC, and the price is £4 10s. Another interesting recent product is the elliptical-cone loud speaker with a flux density of 10,000 lines in the permanent magnet at £2 6s.

*Goodmans Industries, Ltd., Lancelot Road, Wembley, Middx.*

**GRANTONA (150)**

This firm specialises in the manufacture of seamless moulded paper diaphragms, and many new types are shown for the first time, including diaphragms for microphones.

*R. O. Bridger & Co., Ltd., No. 4 Factory, Shelford Place, Church Street, London, N.16.*

**H.M.V. (66 & 76)**

So far as sound broadcast reception—as distinct from television—is concerned, technical interest in the new H.M.V. productions centres mainly around the very advanced

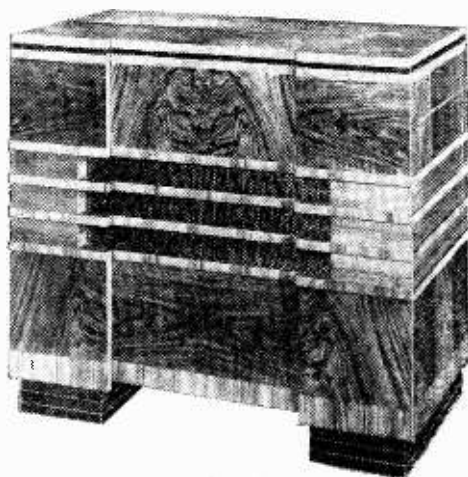

The H.M.V. 10-valve radiogramophone tunes down to 4.85 metres.

5-waveband superheterodyne chassis which is fitted to Models 650, 655 and 660. The specification is a full one, including a total of ten valves, of which the first is a signal-frequency amplifier; there is a separate oscillator valve, an intermediate AF stage and a push-pull output stage delivering 10 watts. Wavelengths from 4.85 upwards are covered in five steps, and there is a variable selectivity control, together with separate regulation of bass and treble response. As a table model (No. 650) the set costs 24 guineas, and as the 660 self-changing radiogramophone its price is 62 guineas. Externally, the most interesting model of all is the 655 "armchair" receiver, planned to give the maximum amount of comfort for the user.

Another new chassis, this time a four-band eight-valve superheterodyne, is included in the Model 469 table receiver at 19 guineas, and in the 479 radiogramophone at 33 guineas. Variable selectivity, signal-

frequency amplification, separate bass and treble tone controls, and an elliptical speaker are among the features of these receivers, of which the lowest wavelength is 11 metres.

As the total number of H.M.V. models shown amount to over 20, it is clearly impossible to describe all of them; the sets range from a simple TRF battery receiver at 7½ guineas to the Model 801 autoradiogram at 80 guineas.

Television apparatus is dealt with as a separate exhibit, where "television only" and television-cum-broadcasting models are shown.

*The Gramophone Co., Ltd., 98-108, Clerkenwell Road, London, E.C.1.*

**HALCYON (35)**

Two high-slope power pentodes in parallel giving an output of 4.5 watts—an exceptionally large one for an AC/DC set—are used in the Halcyon Model U680r, which is an eight-stage superheterodyne covering three wavebands. The circuit arrangement is otherwise fairly conventional, although the tuning system is distinctly novel; the condenser drive is transmitted from a large knob through a heavy flywheel in such a way that the whole scale can be traversed with one or two twists of the wrist. The use of a high-voltage lamp for illuminating the tuning scale seems to be a very sensible feature.

There is also a series of radiogramophones with and without automatic record changers, and there are other table models, including an interesting battery superheterodyne (Model B691) at 14 guineas without batteries. This set has a 6-valve nine-stage circuit and is of the three-band type with an output of 1.5 watts, obtained from a pair of QPP pentodes. When tuned to a strong station, total anode current falls to about 6.4 mA., the average drive current amounting to 13 mA.

*Halcyon Radio, Ltd., Sterling Works, Dagenham, Essex.*

**HARRIES THERMIONICS (3)**

The principal exhibit on this stand is the All-Purpose valve. It is a multi-electrode valve which is so designed that the single type can be employed in all stages of even a complex receiver. Various sets including it are also on view. A demonstration of the Hivac Harries AC/Q output tetrodes is being carried out.

*Harries Thermionics, Ltd., Britannia House, 233, Shaftesbury Avenue, London, W.C.2.*

**HAYNES RADIO (11)**

One of the most interesting receivers on this stand is the Model R3 tuner. It covers

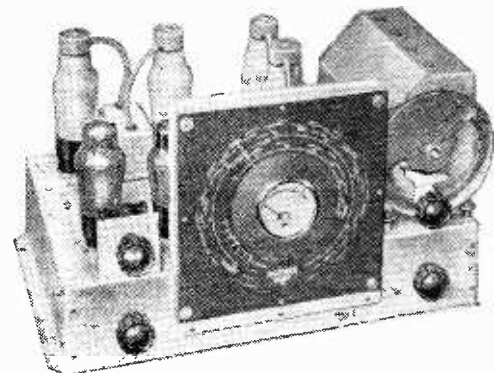

Haynes radio tuner, Model R3, covering broadcast and ultra-short waves.

**Olympia Show Report—**

medium and long wavebands as a straight set, and a portion of the ultra-short waves as a superheterodyne. Two RF stages are used with a diode detector and a triode AF amplifier, while a further triode provides amplified AVC. For the range of 7.2-7.26 metres, however, two additional valves are included, as RF amplifier and frequency-changer. The tuner is priced at £18 10s., and as Model R2 without the USW band at £15 10s.

Other receivers of simpler type are shown, but all are designed to work with the amplifiers produced by this firm. Both 6-watt and 14-watt models are available, and, naturally, have push-pull output. Complete receivers are available as table-models and as radio-gramophones. Loud speakers are also shown.

A television receiver, the Viceiver, is on view, and the vision and sound parts are entirely separate. The vision receiver is a superheterodyne with an RF stage and a triode-hexode frequency-changer. There are four IF stages, a diode detector and one VF stage. A 12in. tube is used with electromagnetic focusing and deflection and the tube is directly viewed. The complete equipment is priced at 120 guineas.

*Haynes Radio, Ltd., Queensway, Enfield, Middx.*

**HEAYBERD (25)**

New additions to this firm's range of battery chargers comprise a miniature unit described as the Tom Thumb Charger. It charges a 2-volt cell at 0.5 amp. and costs 12s. 6d. One other is the Model A.O.9, designed for charging 2-, 6- and 12-volt batteries at 3 amps. maximum. It incorporates a metal rectifier and current regulator and costs £5 5s.

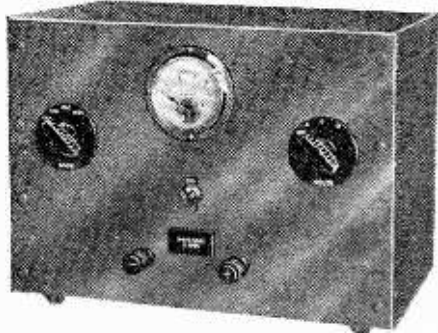

Heyberd Model A.O.9 battery charger.

A long range of charging equipment designed for use in battery service stations is also made by this firm.

In addition Heyberd are showing a comprehensive range of mains transformers and chokes.

*F. C. Heyberd & Co., 10, Finsbury Street, London, E.C.2.*

**HENLEY'S (20)**

Domestic and industrial-type electric soldering irons are shown by this firm. The "Empire" industrial type irons are available in sizes of from 65 to 240 watts consumption and all are fitted with special corrosion proof bits and bit holders.



Solon electric soldering iron fitted with round pencil-bit.

Oval-tapered or round pencil-bits can be supplied with the 65- and 125-watt irons in this series. A 65-watt model with a round pencil-bit costs 11s. 6d., while a 125-watt model with oval-tapered bit costs 22s. 6d.

*W. T. Henley's Telegraph Works Co., Ltd., Holborn Viaduct, London, E.C.1.*

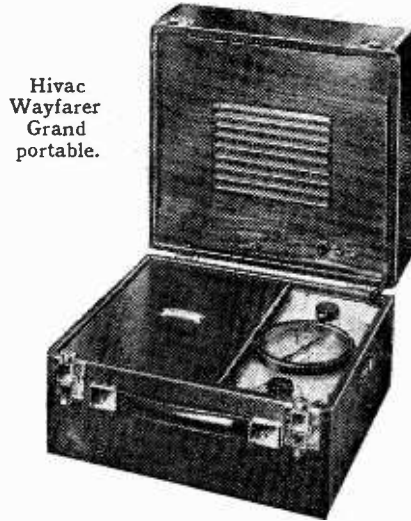

Hivac  
Wayfarer  
Grand  
portable.

**HIVAC (27)**

The special feature on this stand is the Hivac Harries All-Stage valve. It is a multi-grid valve which is so designed that it can be employed in any stage of a receiver with the result that only one valve type is needed.

In addition to a complete range of ordinary valves several new types are shown. There are the QP240, a QPP valve with an output of 1.5 watts; the PX5, a 6-watt triode, and the AC/Q and AC/Qa. These are similar to the American 6L6, but the former has a 4-volt heater and the latter a 6.3-volt heater.

The Wayfarer portable receivers which are now marketed by this firm are also on view.

*The High Vacuum Valve Co., Ltd., 113-117, Farringdon Road, London, E.C.1.*

**HUNT'S (155)**

This firm manufactures fixed condensers in a wide variety of types, their products including small bakelite-cased mica condensers, tubular paper condensers and a very long range of wet and dry electrolytics for high- and low-voltage operation. Trimming and padding condensers assembled on ceramic and on bakelite strips are also included.

The range of servicing apparatus comprises an All-wave Signal Generator with a frequency range of 60 Mc/s to 100 kc/s and a Capacity Analyser and Resistance Bridge. Visual indication of balance is provided.

The capacity range is 10 m-mfds. to 70 mfds., and the resistance range 50 ohms to 2 megohms. This instrument is AC operated and costs £11 11s.

The All-wave Signal Generator costs £12 12s.

*A. H. Hunt, Ltd., Bendon Valley, Garratt Lane, Wandsworth, London, S.W.18.*

**INVICTA (56)**

Two receivers in the new range of Invicta sets incorporate ultra-short-wave ranges covering the television sound transmissions. The Model 310 is a four-waveband receiver with two short-wave ranges covering 6.5-17 metres and 16.5-52 metres. It costs £13 19s. 6d., and there is a radiogramophone equivalent at 22½ guineas. Five

wavebands are provided in the Model 330 which covers 6.5-2,000 metres with only one break between 550 and 800 metres. Both the Models 310 and 330 are fitted with cathode-ray tuning indicators, and have an 8-watt pentode with reverse feed-back feeding into an elliptical diaphragm loud speaker.

There is also a range of three-waveband Popular superheterodynes, AC, universal and battery operation, at prices between £10 and £11 as well as a two-waveband three-valve "straight" battery set at £5 2s. 6d. Television is represented by two instruments, one for vision and sound accompaniment, the other incorporating, in addition, an all-wave broadcast receiver chassis.

*Invicta Radio, Ltd., Radio Works, Parkhurst Road, London, N.7.*

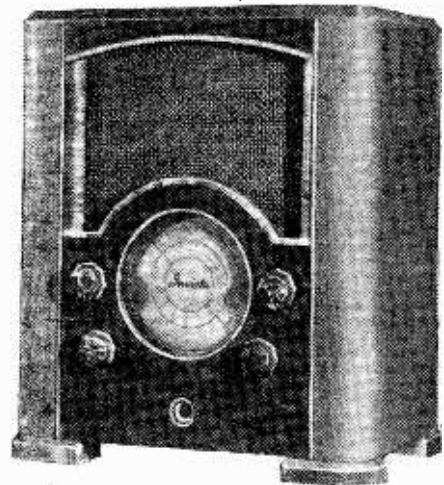

Invicta Model 330 six-waveband receiver.

**J.B. (93)**

This firm is showing variable condensers in a wide variety of types in addition to a number of components. Among the condensers are models suitable for most requirements and gang types naturally predominate.

A new model of the well-known Linacore tuning unit is being shown. This is for all-wave reception, and in addition to the usual medium and long wavebands the tuning range has been extended to cover short waves.

*Jackson Bros. (London), Ltd., 72, St. Thomas' Street, London, S.E.1.*

**K-B RADIO (65)**

A superheterodyne with an output of 8 watts and four wavebands, including short-wave ranges of 12.5 to 38 and 29 to 94 metres, heads the very complete programme of K.B. receivers for the coming season. This receiver is the K.B. 660 for AC mains at 16½ guineas. A triode hexode frequency-changer is followed by two IF stages, a double-diode-triode second detector and single pentode output valve feed a 10-inch loud speaker. The specification includes a cathode-ray tuning indicator and automatic tone compensation. Another interesting feature is the "Alphadex" dial in which station names are arranged in alphabetical groups. This dial, which is edgewise illuminated, is used also in the K.B. 630 AC all-wave superheterodyne at 12½ guineas, and its AC/DC equivalent, the K.B. 632 at 13 guineas. The valve arrangement is similar to that of the



**Olympia Show Report—**

K.B. 660, but the output is 3 watts, and there is only one short-wave range from 16.5-32 metres.

The K.B. 650 and 652 AC and AC/DC all-wave superhets. with four-valve circuits are housed in attractive cabinets with a sloping "Alphadex" dial at the top. The prices at 11 and 11½ guineas respectively.

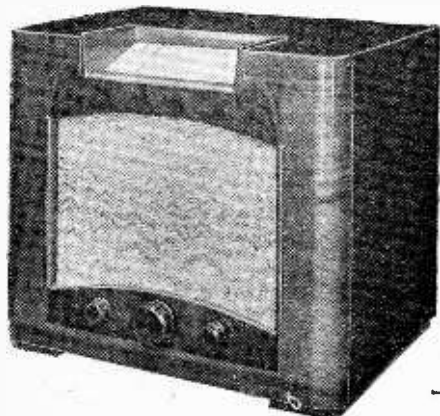

Kolster Brandes Model KB650.

One of the two battery receivers, the K.B. 610, is also fitted with this dial. It has a four-valve superhet. circuit with octode frequency-changer and single pentode output valve, and the price is 11 guineas. The other battery set is a "straight" three-valve receiver with a short-wave range from 18.5-52 metres, which costs 8 guineas. It is housed in a horizontal cabinet with semi-circular dial, and the same type of cabinet is used for the K.B. 640 and 642 AC and AC/DC superheterodynes at 9½ and 10 guineas respectively.

A moving-coil extension speaker and an all-wave Rejctostatic aerial system have been added to the list of K.B. accessories. The aerial system covers 13-2,000 metres without switching.

*Kolster-Brandes, Ltd., Cray Works, Sidcup, Kent.*

**LISSEN (73)**

Five AC superheterodynes with, in most cases, a battery equivalent, form the backbone of the Lissen programme, and range from the Model 8301, a two-waveband mains superhet. at the attractive figure of £6 17s. 6d. to the Model 8114 with two short-wavebands covering 13-33 and 29-82 metres.

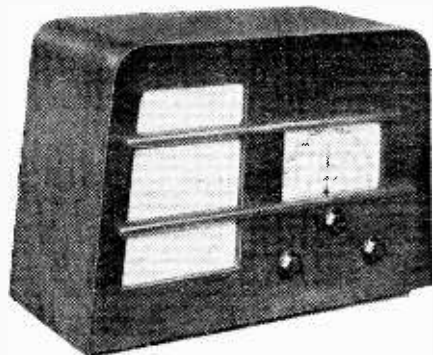

Lissen Model 8301.

The price of this receiver, which has the fullest possible specification, is 17 guineas. The Model 8319 AC superhet. with a single short-wave range from 19-50 metres has the

new Lissen "Monoscale" tuning, and is interesting for the fact that a triode valve is used in the output stage. An AC mains TRF transportable is included in the range, and the "Picnic" battery portable with tilting loud speaker is being continued.

*Lissen, Ltd., Angel Road, Edmonton, London, N.18.*

**McMICHAEL (59)**

The new season's McMichael receivers comprise six table models, five consoles and radiogramophones and two portables. Interesting mechanical features to be noted are the indirectly illuminated "Polychrome" tuning dial, flywheel tuning control, and in some models the well-known McMichael Giant dial.

In the Model 137 twin speaker console this dial rises automatically when the lid of the cabinet is opened. It is illuminated from above; and has a built-in cathode-ray tuning indicator. The receiver is available for AC or AC/DC supplies with outputs of 3 and 2 watts respectively, and the price is 16½ gns.

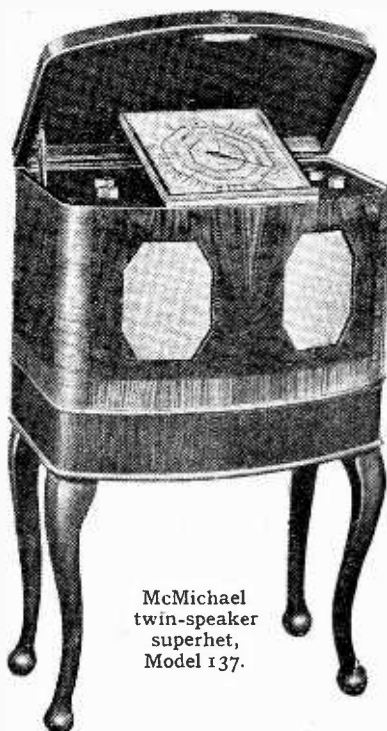

McMichael twin-speaker superhet, Model 137.

for the AC model and 17 gns. for the universal. The twin speaker feature is now available in a table model at 14½ gns. This is the new Model 372 for AC mains, which includes a short-wave range from 16.5-50 metres and has an output of 2.3 watts.

From a technical point of view the new all-wave transportables are of exceptional interest. The Model 374 AC receiver requires no external aerial and tunes down to 16.5 metres. Special attention has been given in the design to noise suppression and the provision of an efficient AVC system. A cathode ray tuning indicator is included, and the price is 16 gns. The battery equivalent of this receiver, the Model 373, costs 14 gns. and tunes down to 19 metres.

Finally, we would draw attention to the new Model 375 radiogramophone, which has a six-valve superheterodyne chassis delivering 6 watts with negative feed-back to twin moving-coil loud speakers. The receiver is housed in an exceptionally fine cabinet, and the price is 29 gns. or 35 gns. with automatic record-changer.

*McMichael Radio, Ltd., Wexham Road, Slough, Bucks.*

**MAGNAVOX (17)**

Loud speakers and small components form the basis of the exhibit of this firm. A very wide range of loud speakers for incorporation in receiving sets is carried, and manufacturers' technical enquiries will be dealt with on the stand. The loud speakers available to the public include the Duode 33 high-fidelity model with double-voice coil, the Sixty-six unit with a power-handling capacity of 20 watts, and a "2-inch" projection loud speaker for public address work. The latter unit is so named from the diameter of the speech coil, which is designed to dissipate heat rapidly and is conservatively rated to handle 25 to 30 watts continuously.

Among the components, which include AF coupling units, whistle filters and battery economy units, there are now an octal valveholder and a range of oval platform valveholders in 4-, 5-, 7- and 9-pin types.

*The Benjamin Electric, Ltd., Brantwood Works, Tariff Road, London, N.17.*

**MARCONIPHONE (53 & 64)**

No fewer than twenty-three receivers are represented on this stand. With the exception of the Model 314, a three-valve "straight" battery set, and the Model 562, battery portable, all receivers in the Marconiphone range are equipped for short-wave reception, many with three short-wave ranges extending down to the television sound transmissions. The Model 561 at 24 gns., for instance, covers 4.85-2,000 metres, leaving only two small and comparatively unimportant gaps. The circuit comprises an RF amplifier, separate oscillator and mixer valves, two IF stages with variable selectivity, double-diode second detector, pentode AF amplifier and two tetrodes in push-pull delivering between 10-12 watts to a special PM speaker. The same chassis is the foundation of the 564 console at 32 gns. and the 563 Autoradiogram at 67 gns., which is housed in a period cabinet with two loud speakers and a built-in record cabinet.

Another group of receivers with five wave-

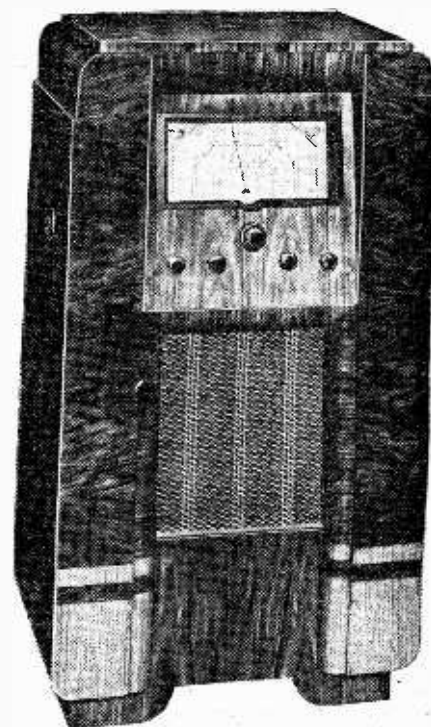

Marconiphone Model 564 console.

**Olympia Show Report—**

bands goes down to 7 metres, and includes the table model 347 at 19 gns. and radio-gramophones at prices ranging from 29½ to 40 gns. There are also four-waveband receivers such as the Model 538 at 19 gns., which go down to 11 metres, and have an RF input amplifier and a tetrode output valve.

The majority of the remaining models cover three wavebands and go down to 16.5 metres. An example of this series is the Model 557 at 12½ gns., which also has an RF stage and makes use of a tetrode power output valve.

Television is represented by a complete sound and vision receiver, the Model 702 at 60 gns., the Model 701 at 80 gns., which also incorporates an all-wave broadcast receiver, and the luxurious "Mastergram" at 120 gns., which also includes an automatic record-changer.

A full range of Marconiphone valves with which are included the new international series with octal bases are displayed.

*The Marconiphone Co., Ltd., 210-212, Tottenham Court Road, London, W.1.*

**MICA & MICANITE SUPPLIES (154)**

Full technical information regarding the properties of mica and Micanite, both from a mechanical and electrical point of view, is obtainable on this stand, and the many applications of this material in the radio industry are illustrated by sample products.

*Mica & Micanite Supplies, Ltd., Mica House, Barnsbury Square, London, N.1.*

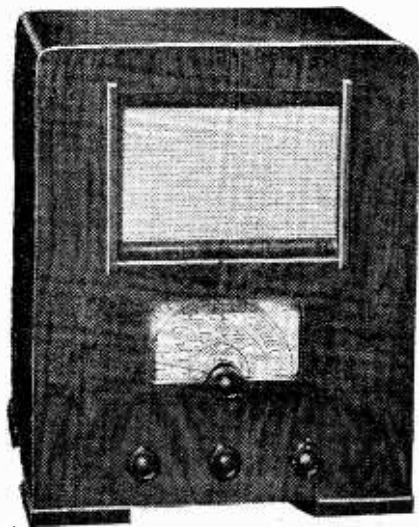

Milnes "Mercury" AC mains superheterodyne.

**MILNES (88)**

The Milnes range of new receivers consists of four all-wave superheterodynes, two being for battery and two for AC mains operation. These are described as the "Saturn," the "Onyx," the "Mercury" and the "Venus" respectively.

The "Onyx" is a five-valve battery model with wave ranges of 12.5 to 51, 200 to 550, and 800 to 2,100 metres. A special feature of this set is that the short-wave range is sub-divided into six bands, each occupying the full range of the tuning scale. Iron-cored IF transformers are fitted. A maximum of 2 watts is provided by two pentodes arranged in Class AB push-pull. This costs £14 5s.

In the "Venus" model, which is AC operated, six valves are used, there being nine tuned circuits in all. The tuning arrangement is the same as in the "Onyx"

model. Delayed AVC, variable selectivity, tuning corrector and noise suppression constitute a few of the interesting features of this set, the price of which is £15 15s.

There is also a full range of Milnes HT units.

*Milnes Radio Co., Ltd., Church Street, Bingley, Yorks.*

**MULLARD (72 & 161)**

One of the most interesting receivers shown on this stand is the MAS8. Among its features is a triple-diode detector and

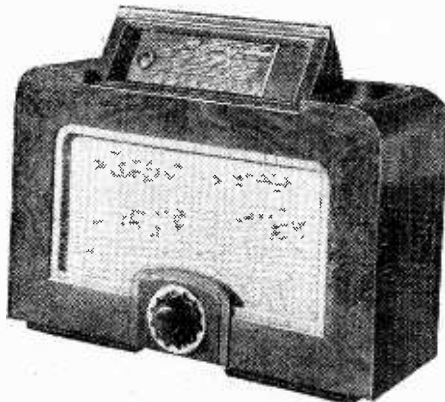

Mullard MAS8 all-wave superheterodyne.

AVC circuit which reduces distortion caused by the AVC diode giving a variable load to the tuned circuit. Variable selectivity is included, the receiver tunes down to 16.7 metres, and negative feed-back is employed. The receiver is for AC mains and is priced at 15 guineas. Small sets include a four-valve battery model tuning down to 19 metres. This is the MBS3 at 9 guineas.

In addition to receivers this firm is showing a wide range of valves and cathode-ray tubes. An indirectly-heated rectifier for television work has been produced. This is the HVR2, which is rated for .3 mA at 6,000 volts, and for a peak inverse voltage of 20,000. There is also a neon voltage-stabilising tube of particular interest for laboratory gear and for the HT supply to the oscillator of SW receivers.

As well as the electrostatically deflected and focused cathode-ray tubes, two new television models for magnetic deflection and focusing have been produced. These are the M46-12 and M46-15, with 12in. and 15in. screens. Rated for 4,000-5,000 volts on the second anode, the first anode requires only 250 volts.

There is also a new high-vacuum oscillograph tube. This is the A41-G4/B4, available with green or blue screens. It has deflector plates specially designed so that an unbalanced input can be used without distortion.

*Mullard Wireless Service Co., Ltd., 225, Tottenham Court Road, London, W.1.*



Mullard TH4A triode-hexode.

**PERTRIX (83)**

The latest product of this firm is a series of dry LT batteries for overseas use only. Three models, having capacities of 270, 330 and 650 amp. hours, are available.

Several additions have been made to the replacement series of Pertrix batteries, which now includes a model for almost every battery set in general use. A long range of Bulldog models is shown.

*Britannia Batteries, Ltd., Union Street, Redditch, Worcs.*

**PHILIPS (68)**

Although broadcast receivers occupy a large portion of the space on this stand, the projection-type television receiver is one of the main features of the exhibit. This receiver embodies a 4in. cathode-ray tube operating at 25,000 volts, and the picture is projected through a lens and mirror system on to a glass screen 20in. by 16in. in size. The receiver is a superheterodyne with one RF stage and two triode-hexode frequency-changers, one for sound and the other for vision. After one stage of IF amplification and detection by a diode the sound signal is

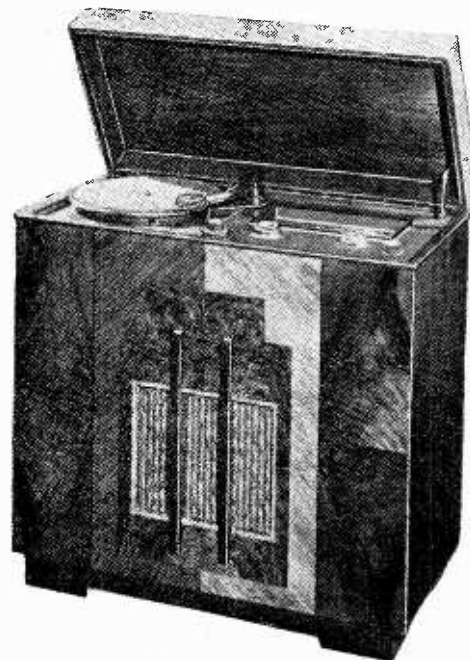

Philips radio-gramophone, Model 699A.

fed into the pick-up terminals of a standard broadcast receiver. The vision receiver has four IF stages, a diode detector and one VF amplifier. The complete equipment is priced at 165 guineas.

The broadcast receivers include an all-wave battery receiver with a two-valve frequency-changer, one IF stage, and a diode-triode detector, AVC valve and AF amplifier. A QPP output valve is fitted, and the short-wave range is 16.5-51 metres. This is the model 714B at 14 guineas. A somewhat smaller set with a pentode output valve is the 716B at 10 guineas.

The model 787 AX is a seven-valve AC set with four wavebands, of which the short ranges are 6-12 metres and 16.7-51 metres. A triode-hexode frequency-changer is used and one IF amplifier with variable selectivity. A special detector circuit using three diodes is adopted in order to avoid distortion due to variable damping on the tuned circuits. Two pentodes are used in the output stage to give an output of 9 watts. Negative feed-back is employed, and volume expansion is secured through the use of a

**Olympia Show Report—**  
control lamp in this circuit. The receiver is listed at 19½ guineas.

*Philips Lamps Ltd., Philips House, 145, Charing Cross Road, London, W.C.2.*

#### PILOT (84)

One of the more ambitious of the wide range of receivers shown on this stand is the Pilot Model U385, a three-band superheterodyne with a total of eight valves (including rectifier and tuning indicator). An output of 6 watts is obtained from a Class A phase-inverted push-pull stage.



Pilot 8-valve receiver.

The Pilot BL550 is a low-priced two-band superheterodyne with iron-cored coils, pentode output and variable tuned control.

An exceptionally wide coverage is given by the U106, which covers wavelengths between 4½ and 2,000 metres in six steps. This set, which has a total of ten valves—again including the rectifier and tuning indicator—gives an output of 14 watts and costs 25 guineas.

*Pilot Radio, Ltd., 87, Park Royal Road, London, N.W.10.*

#### PIX (211)

Among the many different types of aerials made by this firm is one that has a novel fixing arrangement. Known as the Gripon aerial, it costs 4s. 6d. with 40ft. of special aerial wire. Pix accessories include a lightning arrestor, a chemical "earth," and an armchair volume control.

Pix are showing, also, a comprehensive range of valves for battery and AC operation.

*The British Pix Co., Ltd., Pix House, 118, Southwark Street, London, S.E.1.*

#### POLAR (44)

The "Bar-Type" gang condenser is to become the standard model for the coming season, and replaces all other models in the

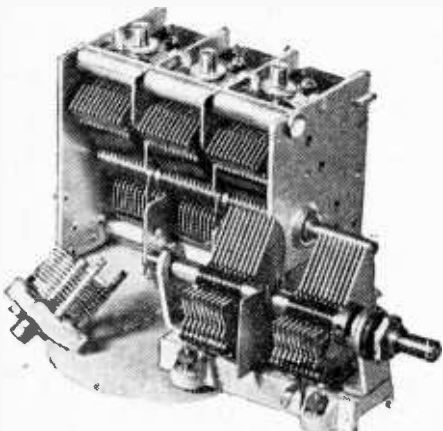

Polar "Bar-Type," short-wave and air trimmer condensers.

two- and three-gang types. The "Midget" condenser is being retained in four-gang form to meet demands for a condenser with this number of sections. The two-gang "Bar-Type" costs 12s., and a three-gang 17s. 6d.

A new condenser drive with dual-ratio reduction mechanism has been developed, and this is known as the New Micro-Horizontal Drive. The ratios are 10 to 1 and 50 to 1, and the price is 9s. 6d.

A dial with station names and a degree scale is fitted, though a wavelength calibration can be supplied in special cases.

Another new item is a dual mica-dielectric trimmer on a ceramic base and made in five different capacities; the smallest is 30 to 100 m-mfds., and the largest 250 to 650 m-mfds. This costs 2s. in all sizes.

In addition the range of Polar-NSF components, comprising volume controls, tubular condensers, resistances, and dry electrolytics, are shown on this stand.

*Wingrove & Rogers, Ltd., Arundel Chambers, 188-189, Strand, London, W.C.2.*

#### PORTADYNE (18)

Easily readable tuning scales on each of the three bands covered by the new Portadyne Model A58 are provided by an ingenious arrangement whereby the entire scale is changed automatically to that appropriate for the band selected by operation of the wavelength switch. The A58 is an AC superheterodyne with eight tuned circuits using the latest type of intermediate frequency coupling; this is in the form of a three-circuit iron-cored transformer tuned to a frequency of 450 kc/s. The circuit arrangement is otherwise fairly conventional, with a triode-hexode frequency-changer and pentode output; the set costs 11 guineas.

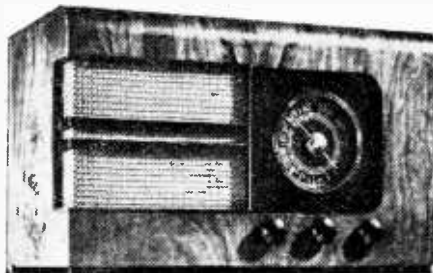

Portadyne all-wave battery superhet.

In addition to other models, there is also an all-wave battery superheterodyne, the Model B48 at £9 17s. 6d. (without batteries). This is a three-band model with an output pentode, and the useful feature of a pilot lamp which can be switched off when not required in order to conserve LT current.

*Dynaport Radio & Television, Ltd., Portadyne Works, 18-19, Gorst Road, London, N.W.10.*

#### PYE (60)

The leading table model in the new Pye range of receivers is the QAC5 at 18 guineas. This receiver has no fewer than five wavebands, one of which is designed to cover the television sound transmissions. The superheterodyne circuit has variable selectivity and QAVC, and among many interesting mechanical details the flywheel tuning control and the Planetary Selector Unit, the latter designed to give high sensitivity on ultra-short waves, are worthy of special mention.

A short-wave band is now included in two of the frame aerial portable sets, namely, the QPB at 15 guineas and the QPAC at 16 guineas. The former has a QP output stage with reverse feed-back.

The Baby Q portable at 8 guineas is a compact battery set and an AC/DC equivalent (the Baby Q/U) has now been introduced at the same price.



Pye Model QAC5.

These leading exhibits are backed by a comprehensive range of table model receivers including the QAC3, a three-waveband superheterodyne at 13½ guineas; the QB3 and QU3, three-waveband superheterodynes for battery and universal mains operation respectively, at 12 guineas; the QAC2, a two-waveband superheterodyne at 8 guineas, and the Q70, a three-valve, two-waveband "straight" receiver, at £8.

Full-sized portables include the QSM "straight" AC portable at 10 guineas, and the QSP "straight" battery portable at £11. Radiogramophones are also shown at prices ranging from 21 guineas to 35 guineas.

Several developments in television design are exemplified in the television receivers shown on this stand. The Model 4044 at 75 guineas is equipped not only for television reception but for broadcast reception with two short-wave ranges covering 13 to 82 metres in addition to the medium and long waves.

*Pye, Ltd., Radio Works, Cambridge.*

#### R.G.D. (67)

As might be expected, the new R.G.D. combined television receiver and radiogramophone—a veritable "Universal Home Entertainer"—is an extremely highly developed piece of apparatus embodying all kinds of refinements in each of its main sections. The total number of valves amount to 34, of which 14 are accounted for in the vision and sound unit, which employs a superheterodyne circuit with RF stage, 2-channel IF amplifier (4 Mc/s wide for vision and 10 kc/s wide for sound) and preset tuning of both vision and sound inputs. There is a three-valve sync impulse separator and the 7-watt push-pull output stage is common to both television sound and the broadcast unit. For work at a considerable distance from the television transmitter, an alternative vision receiver unit comprising a four-valve straight amplifier may be fitted.

The broadcast receiver is a four-band



**Olympia Show Report—**

superheterodyne unit with a signal-frequency stage and variable selectivity, followed by a two-stage resistance-coupled push-pull audio-frequency amplifier. On the gramophone side, an automatic record changer and piezo-electric pick-up are fitted.

Turning to broadcast receivers, an interesting chassis is that included in the Model 623 table receiver at 25 gns, the 628 console at 28 gns., and the 643 radiogramophone at 45 gns. This is a four-band superheterodyne with variable selectivity and an unusually effective AVC system in which control is applied to three stages. There is a three-position selectivity control, combined volume and noise-suppression control, and a three-position bass tone control.

The cheapest R.G.D. receiver this year is a three-band table superheterodyne at 16½ gns., while the most ambitious (apart from the television set) is the 1220 radiogramophone, a 12-valve instrument with 12 watts output at 120 gns.

*Radio Gramophone Development Co., Ltd., Globe Works, Newtown Row, Birmingham, 6.*

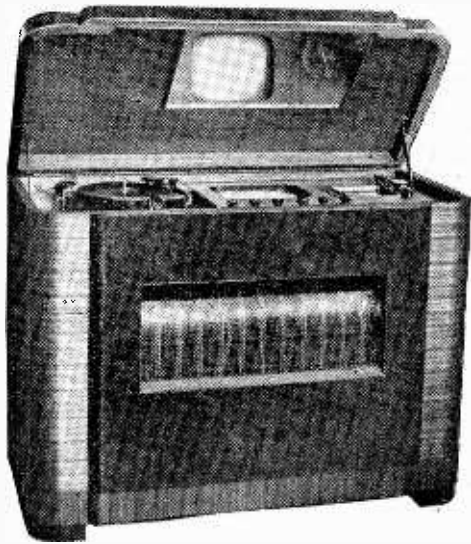

R.G.D. television all-wave auto-radio-gramophone.

**R.S.G.B. (214)**

Some fine examples of short- and ultra-short-wave transmitting and receiving apparatus, designed and built by amateurs, are shown on this stand. The principal apparatus exhibited comprises a crystal-controlled 14 and 28 Mc/s transmitter, a remote-controlled transmitter and receiver, a five-band four-valve short-wave receiver, some 56 Mc/s transmitters and receivers, as well as frequency meters, monitors and measuring apparatus.

This stand is the focal point in the Exhibition for the transmitting experimenter, where acquaintances made over the ether can be confirmed in person.

*The Incorporated Radio Society of Great Britain, 53, Victoria Street, London, S.W.1.*

**RADIOLAB (164)**

Among the new items in the Radiolab range of servicing units is a CR tube voltmeter, a three-range instrument with alternative scale readings of 1,500, 3,000 and 6,000, or 2,000, 4,000 and 8,000 volts. It costs £7 8s. 6d.

The Service Valve Tester is designed to give a complete analysis of the condition of any valve. Two fixed anode voltages, a

continuously variable screen supply and a variable grid voltage supply are now provided. Valves are tested for mutual conductance, for emission and also for inter-electrode insulation. It costs £11 11s.



Everett Edgcumbe Valve Gauge.

Sundry improvements have been made to the Radiolab Visual Valve Tester, and its power unit now gives 400 volts at 100 mA., and it has a voltage regulating circuit. Entirely independent screen and grid voltages are provided.

The All-Purpose Tester, Omni-Selector, All-Wave Oscillator, a new inexpensive valve tester and sundry other servicing units are also shown.

*Everett, Edgcumbe & Co., Ltd., Colindale Works, Hendon, London, N.W.9.*

**RADIOMETERS (162)**

The latest product of this firm is the Faradometer, a resistance and capacity measuring bridge with visual indication of balance and directly calibrated scales. Its range is 50 m-mfds. to 25 mfds. and 50 ohms to 4 megohms. The price is £5 5s.

The All-Valve Tester, Type UVeT, a comprehensive valve testing unit, is also shown. It is AC mains-operated and costs £8 8s.

*Radiometers, Ltd., Eagle House, Jermyn Street, London, S.W.1.*

**RAWLPLUG (91)**

As an aid to the fitting of aerial masts and aerial equipment generally, Rawlplugs are already well known, and an important new application has been found in the installation of "wave" aerials for television. These plugs are now available either in the original fibre or in white bronze, the latter being specially designed for outdoor use in cases where a metal plug may be desirable. In

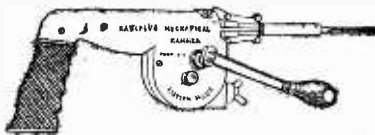

Rawlplug mechanical hammer.

addition to the plugs, various tools for fitting them in stone-work and other substances are shown; the Mechanical Hammer should be a useful tool for those installing aerials on a large scale. Another exhibit of wireless interest is the Rawlplug Electric Soldering Iron, for which bits of several shapes are available.

*The Rawlplug Co., Ltd., Rawlplug House, Cromwell Road, London, S.W.7.*

**REGENTONE (97)**

Among a range of 5- and 6-valve all-wave superheterodynes, pride of place is given to an all-wave portable receiver. This is in-



**SPECIAL 9-VALVE  
FOUR-WAVE SUPERHET  
DE LUXE**

The De Luxe Model of this exceptional receiver includes many interesting features, and combines unusual sensitivity with great flexibility of control. Only receivers now on the market at very much higher prices can claim so high a standard of design and performance.

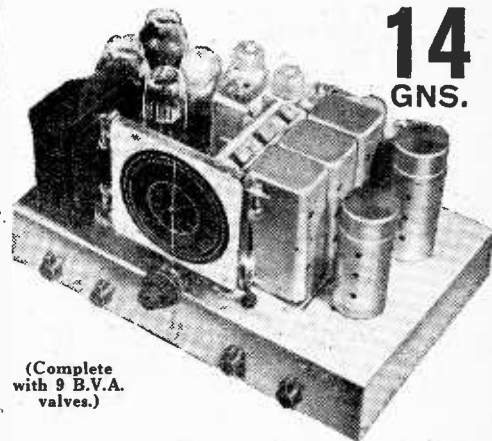

**14  
GNS.**

(Complete with 9 B.V.A. valves.)

**4 wavebands: 12.8-33, 29-80, 190-550, 800-2000 metres. Illuminated dial with principal station names**

**Controls.**—A feature of the receiver is the number of independent controls fitted, making it extremely interesting to operate. These include: sensitivity control (varying bias on R/F stage). Q.A.V.C. with manual muting control for inter-station noise suppression. 5-position wave-change and gramophone switch. Progressive variable tone control operative on radio and gram.

**Circuit in Brief.**—Aerial input to pre-selector circuit, radio frequency amplifier, latest type triode-hexode frequency changer, 2 band-pass I.F.T. coupled I.F. amplifiers, double diode detector, L.F. amplifier and special push-pull pentode output stage. Heavy cadmium plated steel chassis. Finest components and workmanship throughout.

Harries' tetrodes can be fitted in place of pentodes in output stage if desired.

A.C. models ready for immediate delivery. A.C./D.C. models also in production, and will be available for delivery shortly.

**STANDARD MODEL 12 GNS.**

as above, but with triode push-pull output, and fewer controls fitted.

**DEFERRED TERMS**

on application or through our City Agents  
**LONDON RADIO SUPPLY CO.,**  
11, Oat Lane, E.C.2.  
Demonstrations Daily.

All McCarthy receivers supplied complete with valves, knobs, pilot lamps, leads, mains cable and plug. 12 months' guarantee. (Valves 3 months.)

The prices at which McCarthy receivers are advertised include Marconi Royalties.

Cash with order on 7 days' approval. Also write for illustrated catalogue of complete range of all McCarthy receivers.

**MCCARTHY RADIO LTD.**

44a, Westbourne Grove, London, W.2

Telephone: Bayswaier 3201/2.



**Olympia Show Report—**

tended for mains operation on supplies of 100-250 volts AC or DC, and measures only 11in. by 12in. by 8½in. Two frame aerials are included, one for the medium and long wavebands and the other for the short-wave range, which extends from 16 metres to 51 metres. The receiver is a superheterodyne with a triode-hexode frequency-changer, one IF stage, a duo-diode-triode detector, an AF amplifier and a pentode output valve. A permanent-magnet moving-coil speaker is included.

A range of mains units is also shown and conversion units with outputs of the order of 300 watts which are intended for the operation of DC sets from an AC supply.

*Regentone Products, Ltd., Regentone Works, Worton Road, Isleworth, Middx.*

**RESLO (24)**

Microphones and horn type loud speakers for PA work are among the products of this firm, and the PR Dynamic microphone at £3 15s. has been developed for band reinforcement work. The P.M.D. microphone functions on the same principle and has a response flat within  $\pm 4$  db. between 50 and 10,000 cycles. The price of this instrument is 6 guineas.

Aluminium horns of welded construction are also shown and are designed for use with the Type SU6 unit which has an Alnico permanent magnet giving a flux density of 12,000 lines and a treated balsa wood



Reslo SU6 unit  
and 72-inch  
horn.

diaphragm. The price of this unit, which has an impedance of 10 ohms, is 7 guineas.

*Reslo (Sound Equipment), Ltd., 97, Hampstead Road, London, N.W.1.*

**RHODOID (157)**

Rhodoid is a cellulose acetate material with physical properties comparable with those of celluloid, but, thanks to its non-inflammable qualities, with much wider application. It is supplied in sheets, rods, tubes, etc., as well as in the form of a powder for moulding, and is available in a wide range of transparent, translucent and opaque colours. This exhibit suggests various applications of Rhodoid to the manufacture of broadcast apparatus.

*May & Baker, Ltd., 42-43, St. Paul's Churchyard, London, E.C.4.*

**RIST (159)**

All types of insulating and flexible conductors including connecting wires of the push-back type are shown on this stand. The firm makes a speciality of complete wiring assemblies of specifications and drawings.

*Rist's Wires & Cables, Ltd., Waveney Works, Freemanle Road, Lowestoft, Suffolk.*

**ROLA (41)**

The range of loud speakers shown on this stand is far too wide for detailed enumeration, but three items may be singled out for special mention.

The first is the Model G12 PM high fidelity loud speaker which is now available as a stripped model at £4 16s. without transformer or 5 guineas with transformer.

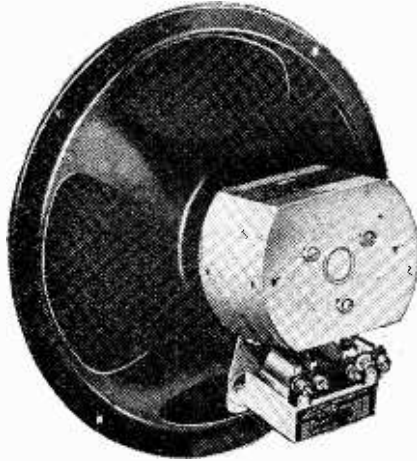

British Rola Model F742-PM.

Next there are the "Roma" and "Rex" universal extension loud speakers with ten alternative impedances making use of a special 8-inch unit with Alnico magnet. The "Roma" unit, complete with cabinet, costs 29s. 6d., and the price of the "Rex," with which is incorporated a volume control on the front of the cabinet, is 49s. 6d.

Finally, we come to the Rola F742 PM speaker, which has been specially developed for use with battery receivers. It has an unusually efficient Alnico magnet giving a flux density of 11,500 lines per sq. cm., and its sensitivity is designed to make the utmost use of the somewhat restricted output from battery-operated sets. The price of 49s. 6d. includes a universal output transformer which is protected by a metal shroud. Special attention has been given to waterproofing, and the speaker is suitable for use in humid climates.

*The British Rola Co., Ltd., Minerva Road, Park Royal, London, N.W.10.*

**NORMAN ROSE ELECTRICAL (207)**

Set testing equipment and a range of small components are shown on this stand.

The Omnisection is an AC-operated valve tester with which the emission of any valve can be ascertained, but it has the additional usefulness that each electrode in the valve can be tested separately for emission.

The Model "94" Radio Analyser is a multi-range instrument which on its voltage scales has a resistance of 1,000 ohms per volt. It measures AC and DC volts, DC current and resistance, and the price is £9 17s. 6d.

There is one new instrument in the series which incorporates the valve tester and a complete radio set analyser in which provision is made for testing electrolytic condensers.

*Norman Rose (Electrical), Ltd., 94, Tottenham Court Road, London, W.1.*

**SALFORD ELECTRICAL INSTRUMENTS (168)**

Instruments for use in the testing and in

the production of radio receivers are made by this firm.

The "Q" meter is a direct reading test set for ascertaining the efficiency of coils, and is calibrated in "Q" values of from 25 to 500. It has a frequency range of 100 to 6,000 kc/s, and is fitted with a 3¼in. meter.

The "L" meter provides a ready means for the measurement of coil inductance, the range being 1 to 5,000 microhenrys. A similar instrument is available for capacity measurements, and this is described as a "C" meter. All these instruments are mains-operated.

Salford also have a multi-range test set for measuring currents from 4 micro-amps. to 5 amps. and voltages, both A.C. and D.C., from 1.2 milli-volts to 500 volts.

An RF rectifier-type voltmeter covering a frequency range of 50 c/s to 1.6 Mc/s, and an RF ammeter of the rectifier type for frequencies up to 10 Mc/s, together with a comprehensive range of meters, are shown.

*Salford Electrical Instruments, Ltd., Peel Works, Silk Street, Salford, 3.*

**SCOTT INSULATED WIRE CO. (156)**

Productions of this firm include wires insulated in coloured silk, cotton and enamel, the conductors being either copper or resistance alloys. Litz wire in various gauges and combinations as used in modern tuning coils is also produced. The Scott Co. specialise in the manufacture of fine wires up to No. 50 SWG.

*The Scott Insulated Wire Co., Ltd., Queensland Works, Holloway, London, N.7.*

**SHAFTESBURY MICROPHONES (92)**

Public address equipment, including microphones, amplifiers, loud speakers and other associated apparatus, makes up the exhibit of this firm. In point of size, one of the most impressive exhibits is a giant horn loud speaker with an air column 11 feet in length and a mouth measuring 6ft. x 2ft.; it is stated that this speaker will deliver a genuine 64 c/s note.

There are two interesting high-gain amplifying chassis for operation on AC/DC mains; the output naturally depends somewhat on the supply voltage, being 9 watts maximum in the case of the small model and 20 watts for the larger. Triple-grid valves are used, and the output of both models is stated to be only 2 db. down at 30 c/s and 3 db. down at 15,000 c/s.

Portable amplifying equipment for dance bands and variety artists is another specialised production of this firm. One of the sets employs the Shaftesbury "Velocity Supreme" microphone, an instrument of the ribbon velocity type.

*Shaftesbury Microphones, Ltd., 24, Aldersgate Street, London, E.C.1.*

**SIEMENS (31)**

The exhibit of this well-known firm comprises batteries of every conceivable variety. HT types are naturally prominent and are available in several discharge ratings. The Cadet series are rated for 6-7 mA., and there are others for 9-10 mA., 12-15 mA., and larger currents.

*Siemens Electric Lamps & Supplies, Ltd., 38-39, Upper Thames Street, London, E.C.4.*

**SOUND SALES (89)**

A re-designed model of the Push-Pull Quality Amplifier is shown on this stand. The output transformer is now mounted on

**Olympia Show Report—**

the chassis and a change has been effected in the method of phase reversal, which now takes place in the penultimate stage and in the new amplifier one of the input terminals can be earthed. It can be supplied as a 4-6 watt or as a 12-14 watt output model.

A new radiogramophone housed in a special cabinet designed to fit into the corner of a room is also shown. A high quality receiver unit, a 4-6 watt push-pull amplifier and automatic record changer constitute a few of its interesting features. Several different radio and gramophone specifications are available, and prices range from £35 to £100.

There is a new amplifier embodying a scheme described as "Tri-channel Amplification." In this unit the high and the extreme low frequencies are amplified separately and independent controls are provided. This unit is designed to be used in conjunction with the 4-6 watt Quality Amplifier. The special unit, which incorporates two beam power valves and HT and LT supply unit, costs £20. The complete equipment with loud speaker costs £40.

One other new product of this firm is a 35-watt power output amplifier fitted with beam power-type valves.

There are some new PA loud speakers, several different patterns of microphone and a long range of mains transformers, chokes, and also some special television mains equipment.

*Sound Sales, Ltd., Marlborough Road, Upper Holloway, London, N.19.*

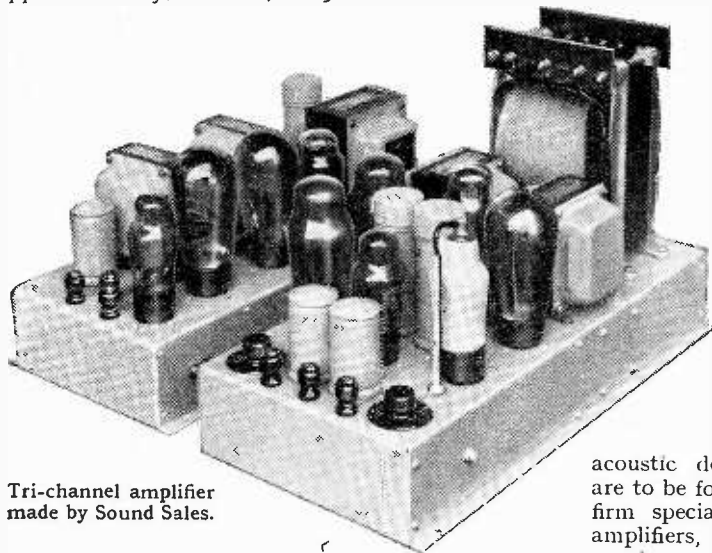

Tri-channel amplifier made by Sound Sales.

**STEATITE & PORCELAIN PRODUCTS (152)**

This firm specialise in the production of ceramic insulating materials for radio frequency use. Their exhibit consists of coil formers, condenser bases and spacers, terminal strips, valve bases and a large variety of other items used by the radio industry. Though most of the exhibits are in Frequentite, the ceramic material Paradox is also shown.

*Steatite & Porcelain Products, Ltd., Stourport-on-Severn, Worcs.*

**STERLING BATTERIES (5)**

HT batteries are the principal product of this firm, but the exhibit also includes a wide range of accumulators and lighting batteries.

*Sterling Batteries, Ltd., Sterling Works, Dagenham, Essex.*

**T.C.C. (38)**

The products of this firm are condensers of every conceivable variety. All types of mica and paper dielectric condensers are to

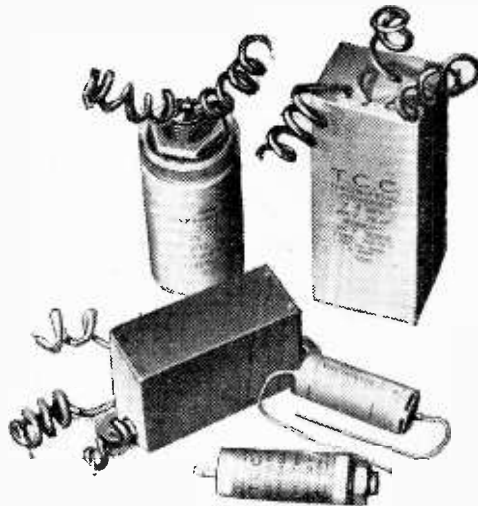

A group of T.C.C. electrolytic condensers.

be found, including special models designed to stand up to the exacting conditions found in the tropics. Moulded-case mica condensers are now available with wire-end connections instead of tags, although the latter type is still listed.

Electrolytic condensers of both the dry and aqueous types are shown for voltage ratings between 12 volts and 550 volts. A special feature is being made of the voltage - regulating properties of wet electrolytic condensers and a new 32 mfd. model is on view.

*The Telegraph Condenser Co., Ltd., Wales Farm Road, North Acton, London, W.3.*

**TANNOY (86)**

Some very fine examples of high-grade electro-acoustic design and construction are to be found on this stand. The firm specialises in the design of amplifiers, microphones, and loud speakers, and a contract has recently been completed for a general order and telephone system for shipboard use. Also for use at sea there has been developed a loud speaker capable of handling over 300 watts and having an efficiency of the order of 50 per cent.

Two new moving-coil microphones are shown. The Type A, with a frequency range of 70-8,000 c/s, is relatively free from wind noise and insensitive to mechanical vibration. Each microphone is fitted with a correcting network which is individually adjusted, and a transformer is incorporated to match a 600-ohm line. The Type B microphone has a higher sensitivity, and although its frequency range is not so wide it is nevertheless most useful as a general-purpose instrument.

The new Tannoy ribbon microphone is smaller than other microphones of this type and is fitted with a specially designed screen which does not affect the frequency characteristic of the instrument. The sensi-

**LET'S  
SHAKE HANDS  
AT STAND 38**



**R**ANGED on Stand No. 38 is the most comprehensive selection of condensers in the world of radio—types that with their introduction (in many cases years ago), have set the standard in condenser practice. Small tubulars, mica types, paper condensers of all sizes and capacities to the biggest transmitting condenser that the stand would comfortably hold—you can see them all—just a review of how T.C.C. out of their 30 years of specialisation, have met the need of set manufacturer, designer and constructor . . . how T.C.C. Dependability has brought leadership.

**T.C.C. WET  
ELECTROLYTICS**

A range that makes all A.C. Receivers

**SURGE PROOF**

**FOUR STANDARD TYPES**

Type	Capacity	Continuous Working Volts
802	16 mfd.	440 volts Peak
802	8 mfd.	440 volts Peak
805	8 mfd.	500 volts Peak
809	32 mfd.	320 volts Peak



**T.C.C.  
ALL-BRITISH  
CONDENSERS**

THE TELEGRAPH CONDENSER CO. LTD., WALES FARM ROAD, NORTH ACTON, W.3.

**Olympia Show Report—**

tivity is -65 db., and the frequency range 50 to over 14,000 c/s. The pole-pieces are designed to avoid reflections at high frequencies, and the directional characteristics are maintained with a sharp minimum at high frequencies.

A two-way loud-speaking telephone system has recently been developed, and there is a multi-way system of the same type with separate 15-watt amplifiers for each channel.

Tannoy rack-built amplifier, incorporating receiver and retractable playing desk.

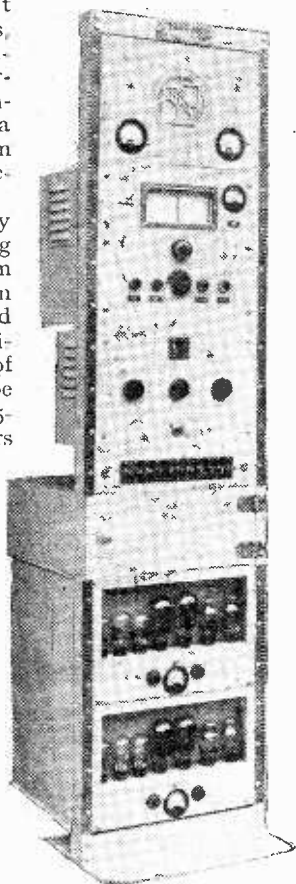

Complete portable sound amplifying equipments and radiogramophones are also shown.

*Tannoy Products, Canterbury Grove, West Norwood, London, S.E.27.*

**TELSEN (90)**

A series of three miniature portable AC/DC sets are shown on this stand; all employ a "straight" three-valve circuit. The smallest weighs 5½ lb., while the two large models weigh 6½ lb.

Testing equipment is an important feature of the Telsen exhibit; the Universal Tester is an extremely versatile instrument embodying a 3½-inch meter with which tests of valves and measurements of capacity may be made as well as the usual measurements

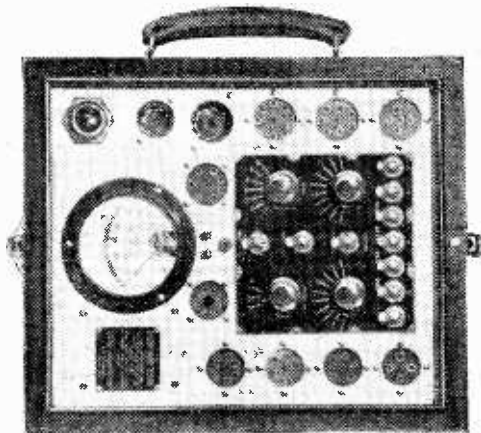

Telsen Lystan valve tester.

of DC voltage and AC voltage. The instrument is entirely AC operated, and includes a built-in source of supply of any heater voltage between 0.5 and 49 volts.

All frequencies between 22 megacycles and 150 kilocycles are covered without recourse to harmonics by the Telsen Signal Generator, which, again, is AC operated and is entirely screened in a steel container. Direct readings on a large engraved scale of any condenser capacity within the usual limits are given by the Telsen Capacity Analyser; the condensers are tested under working voltage, and thus faults which would not be detected by a low-voltage test are revealed.

*Telsen Electric Co. (1935), Ltd., Fitz-george Street, Rochdale Road, Manchester, 9.*

**TEXALOOM RADIO (15)**

Woven fibre is used as the external covering of the cabinets in which Texaloom "radio furniture" is housed. The chassis, which includes an eight-stage, all-wave superheterodyne circuit with a modern specification, is mounted as a console, a bookcase, a combined sideboard and bookcase or as a cocktail cabinet. In all cases

Texaloom side-board - bookcase receiver.

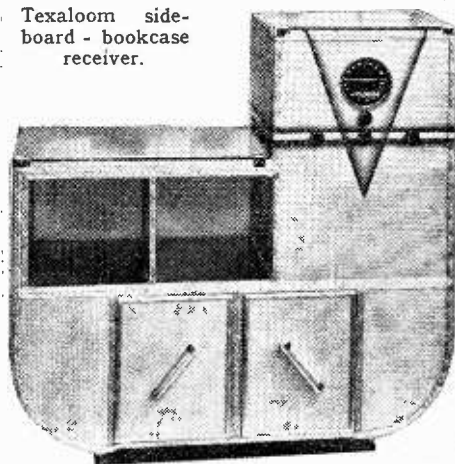

the speaker is completely concealed behind the woven fibre covering.

*Texaloom Radio, Ltd., 806, High Road, Tottenham, London, N.17.*

**TUCKER EYELET CO. (102)**

This firm specialises in small metal press-ware, and their exhibit comprises a wide range of eyelets, valve caps, fuse caps, battery sockets, and soldering tags.

*George Tucker Eyelet Co., Ltd., Cuckoo Road, Birmingham, 7.*

**TUNGSRAM (36)**

The exhibit of this firm is valves, and a complete range of battery and mains types is shown. Recent additions to the former are the HL2 triode with a high amplification factor and a non-microphonic construction, and a hexode frequency-changer. Among the AC types the APP4E merits attention. With 250 volts applied to screen and anode it is capable of an output of 8.8 watts with 10 per cent. distortion, and at 375 volts anode potential a pair will give out no less than 28.5 watts. The valve is a pentode, and Class AB push-pull is used for the large output.

A similar valve with a 6.3-volt heater is available in the Octal-base range under the

type number of the PP6E. This range contains all classes of valves listed under American type-numbers and having similar characteristics to the American valves. It includes, however, a triode-hexode frequency-changer which is specially recommended for short-wave operation. A series of cathode-ray tuning indicators is also on view.

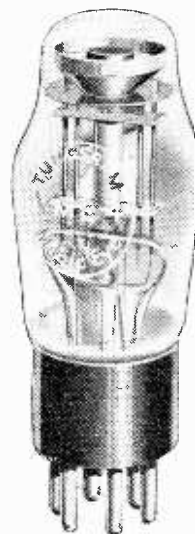

Tungsramp ME4 cathode-ray tuning indicator.

In addition to ordinary types a number of large power valves is shown. These include the P-26/500, the P-27/500, and the P-28/500. The last is designed for Class B operation, and a pair in push-pull will give an output of 50 watts with a 500 volts HT supply.

*British Tungsramp Radio Works, Ltd., West Road, Tottenham, London, N.17.*

**ULTRA (63)**

Prominently displayed on this stand are the Ultra television receivers. The models T20 and T30 AW have 15 and 19 valves respectively; the former is for television sound and vision only, while the latter includes an all-wave receiver. Both give a picture of about 7½ in. by 6¼ in. The model T40 AW is similar to the T30 AW in regard to the electrical circuits, but has different cabinet work and a larger tube, giving a picture 10 in. by 8 in.; in this model the tube is viewed indirectly with the aid of a mirror.

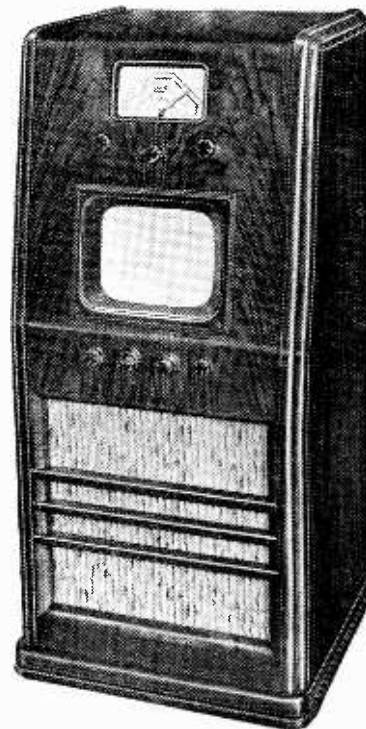

Ultra Television Receiver, Model T30 AW.

The receivers are superheterodynes with an RF stage and a triode-hexode frequency-changer. The sound and vision intermedi-



**Olympia Show Report—**

ate frequencies are 2.6 Mc/s and 6.1 Mc/s. A wide range of broadcast receivers is also being shown. The model 50 at 13½ guineas is a superheterodyne covering 16.8-50 metres on short waves as well as the medium and long wavebands. An RF stage is used and a triode-hexode frequency-changer; the output is 3.5 watts. A similar receiver, the 49, for AC/DC operation, costs 14½ guineas. A battery model of similar general design but incorporating a QPP output stage is available at 12 guineas; this is the model 123, and the output is 700 milliwatts.

Ultra Electric, Ltd., Western Avenue, Acton, London. W.3.

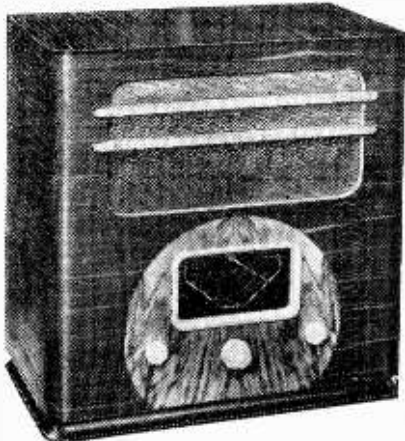

Ultra 50 5-valve AC superheterodyne

**362 VALVES (210)**

Large power valves and transmitting valves are shown by this firm, but, in addition, a number of small types are on view. These include the SR2 and SR4, which are battery and mains types specially designed for use in super-regenerative receivers, and the MP4. This last is a mains valve of the tetrode type, and its particular feature is that the anode is split into two sections with independent connections. It can, therefore, be used as a split-anode magnetron.

The power valves include the PX25 and PX25a, triodes rated for 30 watts anode dissipation; under normal conditions they give outputs of 6 and 7 watts respectively. The transmitting valves include a number of RF pentodes, of which the RFP15 is a typical specimen. Rated for 500 volts, it will give an output of 21 watts and can be modulated in the suppressor grid by an AF power of 1 watt.

The 362 Radio Valve Co., Ltd., 324-326, Liverpool Road, London, N.7.

**VARLEY (99)**

Coils for radio, audio, and intermediate frequencies comprise the Varley exhibit. An addition to the range of Nicore ganged units is a three-gang superhet coil assembly which includes band-pass and oscillator coils suitable for an intermediate frequency of 465 kc/s. This unit can be used either with a shaped-plate superheterodyne condenser or with a standard condenser and additional padding capacity.

There is also a 465-kc/s IF transformer of the variable coupling type. The actual variation of band width is made through an auxiliary coupling winding, the change-over from "high selectivity" to "high fidelity" being effected by operation of a single-pole double-throw switch.

A useful addition to the modern type of superheterodyne with an intermediate fre-

quency of 465 kc/s is the Varley IF Filter, designed to eliminate morse interference, which is particularly likely to give trouble in coastal districts. The filter comprises a coil and tuning condenser in a screened can and costs 4s. 3d.

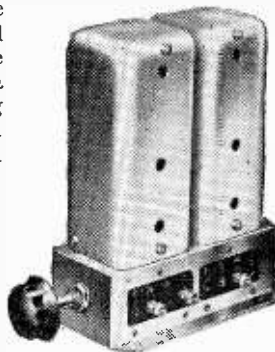

Varley three-band superhet coil unit.

Varley (Oliver Pell Control, Ltd.), Cambridge Place, Woolwich, London, S.E.18.

**VIDOR (33)**

An unusual arrangement has been adopted for the four wave ranges of the Vidor "straight" receivers, which are made in both battery and mains models. The ranges are 13.5-48.5 m.; 75-210 m.; 200-550 m.; 900-2,000 m. It will thus be seen that the second range includes the shipping telephony and 160-metre amateur wavebands. Both sets employ a variable-mu HF pentode in the HF stage, which is tuned on all bands, and an output pentode. The battery version costs £8 2s. 6d., and the AC/DC model is priced at £9 7s. 6d.

Another Vidor "straight" model is the 273, which, in spite of its low price of £5 12s. 6d. (without batteries), includes three tuned circuits.

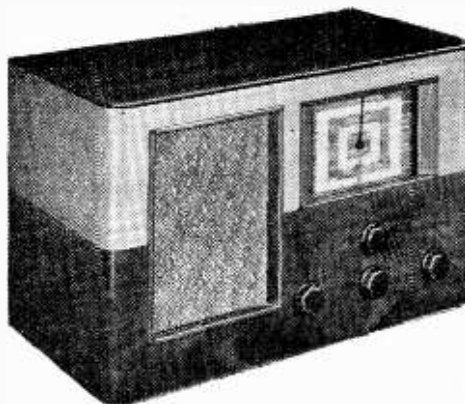

Vidor Model 268 receiver.

Several improvements have been made to the compact Vidor portable, which weighs about 16 lb. complete and costs £6 19s. 6d., complete with batteries.

Vidor, Ltd., West Street, Erith, Kent.

**W.B. (75)**

The current range of Stentorian loud speakers has been extended by the addition of several interesting new models, notably, the "Planoflex" high-quality speaker at 5 gns., in which a box baffle plays an important part, and the "Ellipsis" PM loud speaker with elliptical diaphragm at 42s.

This firm has now entered the receiver market and is showing a four-waveband AC superheterodyne with individual dials for each band, a four-valve all-wave battery superheterodyne, a three-valve all-wave AC receiver and two battery transportables.

Amplifiers for PA work and special speakers with directional baffles are also included, and the 25-watt AC equipment may

**NOTABLE  
FEATURES  
of the New  
ROLA F 742-PM**

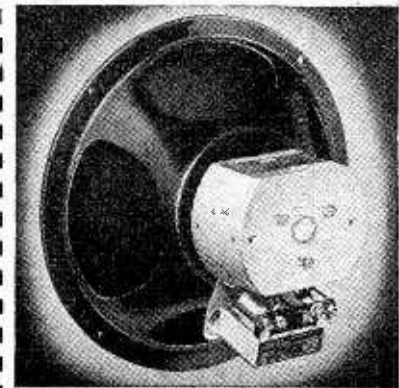

**AN ULTRA-SENSITIVE  
UNIT OF MODERATE  
SIZE AND PRICE . . .**

The sensitivity of the Rola F742-PM is of an order usually associated only with speakers of much greater size and price. This remarkable unit measuring 9¾" in diameter and selling at 49/6 possesses a flux density of 11,500 lines per square centimeter, equivalent to that of the famous G12-PM. This extreme sensitivity renders it specially suitable for battery set or extension speaker use and for replacement purposes generally. The use of a new magnet material "Alnico" and of a special damp-proof and dust-proof metal and compound shielded transformer provides further proof of the care given to every feature of its construction. Write to-day for details.

Model  
F 742-  
PM 49/6

WITHOUT TRANSFORMER 42/-  
OVER 8 MILLION IN USE

**ROLA**

*The World's Finest Reproducers*

**THE BRITISH ROLA CO., LTD.**  
MINERVA ROAD, PARK ROYAL, N.W.10.  
PHONE: WILLESDEN 4322-3-4-5-6.

**Olympia Show Report—**

be quoted as an example. The amplifier has a level response from 50-10,000 c/s within  $\pm 2$  db., and is built into a case with a gramophone turntable and pick-up. Including a 30-watt PA speaker with directional horn, this outfit costs 45 gns.

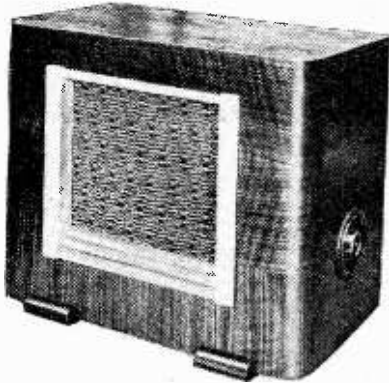

Stentorian extension speaker, Type 38SC.

Components, including valveholders and switches, are continued, one of the most notable of the accessories being the Long Arm Remote Control unit for use with W.B. extension loud speakers.

*Whiteley Electrical Radio Co., Ltd.,  
Victoria Street, Mansfield, Notts.*

**WEARITE (165)**

A new addition to the Wearite range of components is the Triogen three-range coil. Using a 0.0005 mfd. condenser it covers wavebands of 19 to 48, 200 to 550, and 900 to 2,100 metres respectively. With built-in trimmers and wave-change switch, the price is 9s. 6d.

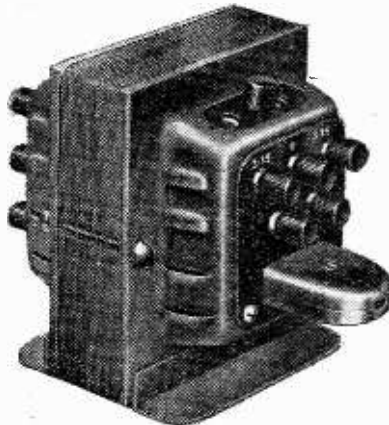

Wearite Universal mains transformer.

The Universal mains transformer is also a new component designed to have the widest possible application. It gives an AC output of 250-0-250, or 350-0-350 volts at 80 mA; there is a 6.3-volt winding centre tapped and also tapped for 4-volt valves. The rectifier valve winding is tapped for 4- or 5-volt valves. A primary voltage selector and safety plug connection are fitted, and the price is 25s.

Wearite are showing a long-range of servicing and test apparatus, comprising an All-wave Oscillator unit, 20 Mc/s to 100 kc/s; a comprehensive meter unit, a Valve-testing unit and a new Condenser Analyser and Resistance Bridge. Capacity, power factor and leakage tests up to 500 volts DC can be made on condensers. This bridge costs £9 9s.

*Wright & Weaire, Ltd., 740, High Road,  
Tottenham, London, N.17.*

**WESTINGHOUSE (77)**

A new range of uncased metal rectifiers is now available, and these replace the earlier models which were enclosed in perforated metal cases. This change has enabled a considerable reduction in prices to be effected. For HT use the new models are HT14, giving an output of 130 volts at 20 mA; HT15, 200 volts, 30 mA. output; HT16, 300 volts, 60 mA. output, and HT17, 200 volts, 100 mA. output. Their prices are 10s., 12s. 6d., 13s. and 15s. respectively.

Five new LT units have been introduced. They have the Type numbers LT7, LT8, LT9, LT10 and LT11. They give rectified outputs ranging from 2 volts at 0.5 amp. to 12 volts at 2 amps. The LT7 costs 6s. 6d. and the LT10 47s. 6d.

The current range of Westectors, the H and the J type high-voltage rectifiers, which are especially suitable for obtaining the DC voltage needed in CR tube and television work, are shown, together with a series of instrument metal rectifiers.

In addition, Westinghouse are showing a comprehensive range of battery charging equipment, varying in size from a small

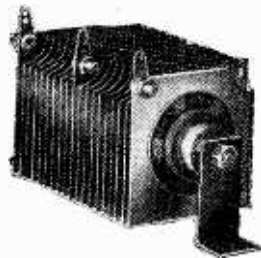

Model HT.15  
Westinghouse  
metal rectifier.

car battery trickle charger to large models for battery service station use.

*Westinghouse Brake & Signal Co., Ltd.,  
82, York Road, King's Cross, London, N.1.*

**WESTON (167)**

The latest Weston instrument is the Super-sensitive Analyser Model E772, which has been designed not only to meet the requirements of radio servicing, but also to serve as a basis for television testing gear. The instrument has the extraordinary high sensitivity of 20,000 ohms per volt, and so there is much justification for the claim made that in many respects it can take the place of a valve voltmeter or an electrostatic voltmeter. There are five DC and AC voltage

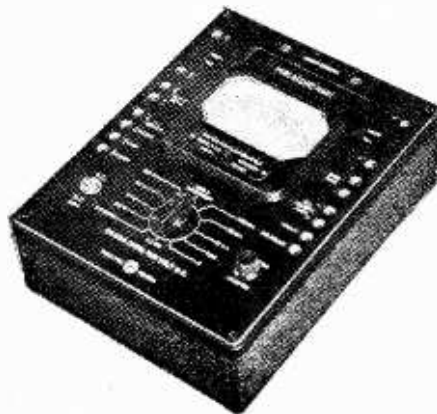

The new Weston high-sensitivity analyser.

ranges and the same number of DC current ranges, the lowest being 100 microamperes. External shunts can be supplied for higher ranges, while AC currents of the order commonly encountered in radio practice can also be measured.

Measurements of resistance values up to 10 megohms are made without external bat-

teries; the first scale division of the lowest resistance range is 0.02 ohm. Provision is also made for the measurement of capacity and output power.

*Weston Electrical Instrument Co., Ltd.,  
Kingston By-Pass, Surbiton, Surrey.*

**The Radio Industry**

THE aerial, feeder and distribution system used for the television demonstrations at Olympia were installed by Baird Television, Ltd., after exhaustive tests to determine the best arrangement from the point of view of signal-to-noise ratio.

“The Little Princess” portable recently reviewed in our pages has been taken over by British Television Supplies, Ltd., 8-10, Charing Cross Road, London, W.C.2, and the price has been altered to 8 guineas.

Radio Industries Development Co., of Birch Street, Northwood, Hanley, Stoke-on-Trent, have just introduced two new Ridco short-wave converters. The Ranger model, which employs a triode-hexode frequency-changer and covers a waverange of from 12-60 metres in two stages, is available for AC, AC/DC or battery feed.

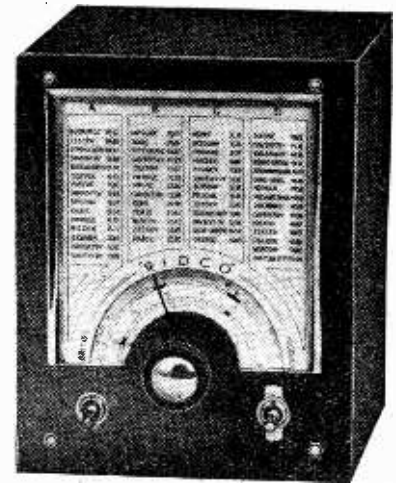

The Ridco Ranger short-wave converter.

The Cub model includes a simple autodyne frequency-changer. These instruments are being shown by Cadisch and Sons at Olympia.

Philco states that Braille tuning dials for the use of the blind can be supplied for the recently introduced “Empire Twenty-two” model.

The new season's series of Wharfedale loud speakers includes four chassis, ranging from the Standard at 25s. to the Auditorium at 90s. (both including transformers). There are also six cabinet speakers, including a corner cabinet model at 55s., which may be suspended from the picture rail.

During the Olympia Exhibition, Voigt high-quality loud speakers will be demonstrated at 2, Beaconsfield Terrace Road, opposite the main Olympia goods entrance at the back of the building. The hours of demonstration are from 11 a.m. to 1 p.m. and from 3 p.m. to 10.30 p.m.—half an hour later than the closing time of the Exhibition.

Television receivers are now available from Murphy Radio, Ltd., and are being produced in two types. Both have a picture size of 9 x 7 inches and Type A with a wide band width is for use within 15 miles of Alexandra Palace. Beyond this distance the Type B should be specified. It has a smaller band width but higher sensitivity. The price in each case is £65 and a special aerial system with 75ft. of co-axial feeder costs £6 extra.